

## N-channel 600 V, 0.440 $\Omega$ typ., 8 A MDmesh™ DM2 Power MOSFET in a DPAK package

Datasheet - production data

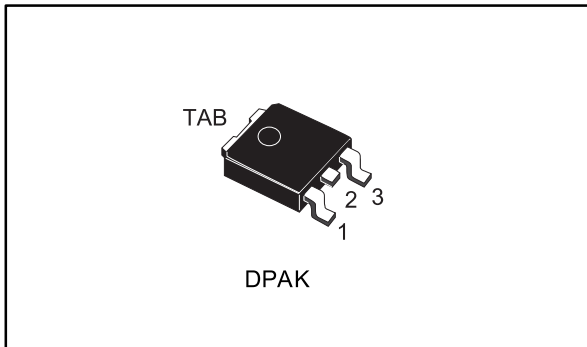
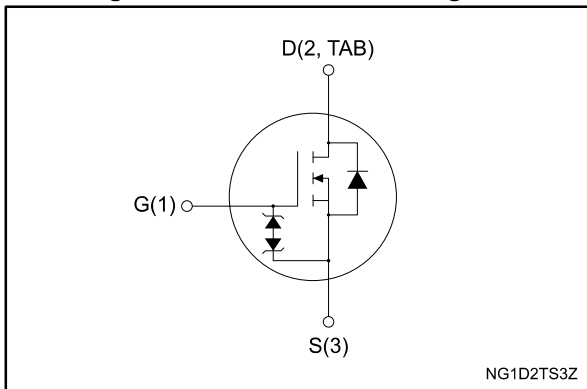

Figure 1: Internal schematic diagram



### Features

Order code	$V_{DS}$ @ $T_{Jmax.}$	$R_{DS(on)}$ max.	$I_D$	$P_{TOT}$
STD10N60DM2	650 V	0.530 $\Omega$	8 A	109 W

- Fast-recovery body diode
- Extremely low gate charge and input capacitance
- Low on-resistance
- 100% avalanche tested
- Extremely high dv/dt ruggedness
- Zener-protected

### Applications

- Switching applications

### Description

This high voltage N-channel Power MOSFET is part of the MDmesh™ DM2 fast recovery diode series. It offers very low recovery charge ( $Q_{rr}$ ) and time ( $t_{rr}$ ) combined with low  $R_{DS(on)}$ , rendering it suitable for the most demanding high efficiency converters and ideal for bridge topologies and ZVS phase-shift converters.

Table 1: Device summary

Order code	Marking	Package	Packing
STD10N60DM2	10N60DM2	DPAK	Tape and reel

---

## Contents

<b>1</b>	<b>Electrical ratings .....</b>	<b>3</b>
<b>2</b>	<b>Electrical characteristics .....</b>	<b>4</b>
	2.1 Electrical characteristics (curves).....	6
<b>3</b>	<b>Test circuits .....</b>	<b>8</b>
<b>4</b>	<b>Package information .....</b>	<b>9</b>
	4.1 DPAK (TO-252) type A package information.....	9
	4.2 DPAK (TO-252) packing information.....	11
<b>5</b>	<b>Revision history .....</b>	<b>13</b>

# 1 Electrical ratings

**Table 2: Absolute maximum ratings**

Symbol	Parameter	Value	Unit
$V_{GS}$	Gate-source voltage	$\pm 25$	V
$I_D$	Drain current (continuous) at $T_{case} = 25\text{ }^\circ\text{C}$	8	A
	Drain current (continuous) at $T_{case} = 100\text{ }^\circ\text{C}$	5	
$I_{DM}^{(1)}$	Drain current (pulsed)	32	A
$P_{TOT}$	Total dissipation at $T_{case} = 25\text{ }^\circ\text{C}$	109	W
$dv/dt^{(2)}$	Peak diode recovery voltage slope	40	V/ns
$dv/dt^{(3)}$	MOSFET $dv/dt$ ruggedness	50	
$T_{stg}$	Storage temperature range	-55 to 150	$^\circ\text{C}$
$T_j$	Operating junction temperature range		

**Notes:**

- (1) Pulse width is limited by safe operating area.  
 (2)  $I_{SD} \leq 8\text{ A}$ ,  $di/dt=900\text{ A}/\mu\text{s}$ ;  $V_{DS\text{ peak}} < V_{(BR)DSS}$ ,  $V_{DD} = 400\text{ V}$   
 (3)  $V_{DS} \leq 480\text{ V}$ .

**Table 3: Thermal data**

Symbol	Parameter	Value	Unit
$R_{thj-case}$	Thermal resistance junction-case	1.14	$^\circ\text{C}/\text{W}$
$R_{thj-pcb}^{(1)}$	Thermal resistance junction-ambient	50	

**Notes:**

- (1) When mounted on 1 inch<sup>2</sup> FR-4 board, 2oz Cu.

**Table 4: Avalanche characteristics**

Symbol	Parameter	Value	Unit
$I_{AR}^{(1)}$	Avalanche current, repetitive or not repetitive	2	A
$E_{AS}^{(2)}$	Single pulse avalanche energy	300	mJ

**Notes:**

- (1) pulse width limited by  $T_{jmax}$   
 (2) starting  $T_j = 25\text{ }^\circ\text{C}$ ,  $I_D = I_{AR}$ ,  $V_{DD} = 50\text{ V}$ .

## 2 Electrical characteristics

( $T_{\text{case}} = 25\text{ °C}$  unless otherwise specified)

**Table 5: Static**

Symbol	Parameter	Test conditions	Min.	Typ.	Max.	Unit
$V_{(\text{BR})\text{DSS}}$	Drain-source breakdown voltage	$V_{\text{GS}} = 0\text{ V}$ , $I_{\text{D}} = 1\text{ mA}$	600			V
$I_{\text{DSS}}$	Zero gate voltage drain current	$V_{\text{GS}} = 0\text{ V}$ , $V_{\text{DS}} = 600\text{ V}$			1.5	$\mu\text{A}$
		$V_{\text{GS}} = 0\text{ V}$ , $V_{\text{DS}} = 600\text{ V}$ , $T_{\text{case}} = 125\text{ °C}^{(1)}$			100	
$I_{\text{GSS}}$	Gate-body leakage current	$V_{\text{DS}} = 0\text{ V}$ , $V_{\text{GS}} = \pm 25\text{ V}$			$\pm 10$	$\mu\text{A}$
$V_{\text{GS(th)}}$	Gate threshold voltage	$V_{\text{DS}} = V_{\text{GS}}$ , $I_{\text{D}} = 250\text{ }\mu\text{A}$	3	4	5	V
$R_{\text{DS(on)}}$	Static drain-source on-resistance	$V_{\text{GS}} = 10\text{ V}$ , $I_{\text{D}} = 4\text{ A}$		0.440	0.530	$\Omega$

**Notes:**

<sup>(1)</sup>Defined by design, not subject to production test.

**Table 6: Dynamic**

Symbol	Parameter	Test conditions	Min.	Typ.	Max.	Unit
$C_{\text{ISS}}$	Input capacitance	$V_{\text{DS}} = 100\text{ V}$ , $f = 1\text{ MHz}$ , $V_{\text{GS}} = 0\text{ V}$	-	529	-	$\mu\text{F}$
$C_{\text{OSS}}$	Output capacitance		-	28	-	
$C_{\text{RSS}}$	Reverse transfer capacitance		-	0.72	-	
$C_{\text{OSS eq.}}^{(1)}$	Equivalent output capacitance	$V_{\text{DS}} = 0\text{ to }480\text{ V}$ , $V_{\text{GS}} = 0\text{ V}$	-	47	-	$\mu\text{F}$
$R_{\text{G}}$	Intrinsic gate resistance	$f = 1\text{ MHz}$ , $I_{\text{D}} = 0\text{ A}$	-	6.5	-	$\Omega$
$Q_{\text{g}}$	Total gate charge	$V_{\text{DD}} = 480\text{ V}$ , $I_{\text{D}} = 8\text{ A}$ , $V_{\text{GS}} = 10\text{ V}$ (see <a href="#">Figure 15</a> : "Test circuit for gate charge behavior")	-	15	-	nC
$Q_{\text{gs}}$	Gate-source charge		-	3.7	-	
$Q_{\text{gd}}$	Gate-drain charge		-	8	-	

**Notes:**

<sup>(1)</sup>  $C_{\text{OSS eq.}}$  is defined as a constant equivalent capacitance giving the same charging time as  $C_{\text{OSS}}$  when  $V_{\text{DS}}$  increases from 0 to 80%  $V_{\text{DSS}}$ .

**Table 7: Switching times**

Symbol	Parameter	Test conditions	Min.	Typ.	Max.	Unit
$t_{\text{d(on)}}$	Turn-on delay time	$V_{\text{DD}} = 300\text{ V}$ , $I_{\text{D}} = 4\text{ A}$ $R_{\text{G}} = 4.7\text{ }\Omega$ , $V_{\text{GS}} = 10\text{ V}$ (see <a href="#">Figure 14</a> : "Test circuit for resistive load switching times" and <a href="#">Figure 19</a> : "Switching time waveform")	-	11	-	ns
$t_{\text{r}}$	Rise time		-	5	-	
$t_{\text{d(off)}}$	Turn-off delay time		-	28	-	
$t_{\text{f}}$	Fall time		-	11.5	-	

Table 8: Source-drain diode

Symbol	Parameter	Test conditions	Min.	Typ.	Max.	Unit
$I_{SD}^{(1)}$	Source-drain current		-		8	A
$I_{SDM}^{(2)}$	Source-drain current (pulsed)		-		32	A
$V_{SD}^{(3)}$	Forward on voltage	$V_{GS} = 0\text{ V}$ , $I_{SD} = 8\text{ A}$	-		1.6	V
$t_{rr}$	Reverse recovery time	$I_{SD} = 8\text{ A}$ , $di/dt = 100\text{ A}/\mu\text{s}$ , $V_{DD} = 60\text{ V}$ (see <a href="#">Figure 16</a> : "Test circuit for inductive load switching and diode recovery times")	-	90		ns
$Q_{rr}$	Reverse recovery charge		-	225		$\mu\text{C}$
$I_{RRM}$	Reverse recovery current		-	5		A
$t_{rr}$	Reverse recovery time	$I_{SD} = 8\text{ A}$ , $di/dt = 100\text{ A}/\mu\text{s}$ , $V_{DD} = 60\text{ V}$ , $T_j = 150\text{ }^\circ\text{C}$ (see <a href="#">Figure 16</a> : "Test circuit for inductive load switching and diode recovery times")	-	190		ns
$Q_{rr}$	Reverse recovery charge		-	684		nC
$I_{RRM}$	Reverse recovery current		-	7.2		A

**Notes:**

- (1) Limited by maximum junction temperature.  
(2) Pulse width is limited by safe operating area.  
(3) Pulse test: pulse duration = 300  $\mu\text{s}$ , duty cycle 1.5%.

Table 9: Gate-source Zener diode

Symbol	Parameter	Test conditions	Min.	Typ.	Max.	Unit
$V_{(BR)GSO}$	Gate-source breakdown voltage	$I_{GS} = \pm 250\text{ }\mu\text{A}$ , $I_D = 0\text{ A}$	$\pm 30$	-	-	V

The built-in back-to-back Zener diodes are specifically designed to enhance the ESD performance of the device. The Zener voltage facilitates efficient and cost-effective device integrity protection, thus eliminating the need for additional external componentry.

## 2.1 Electrical characteristics (curves)

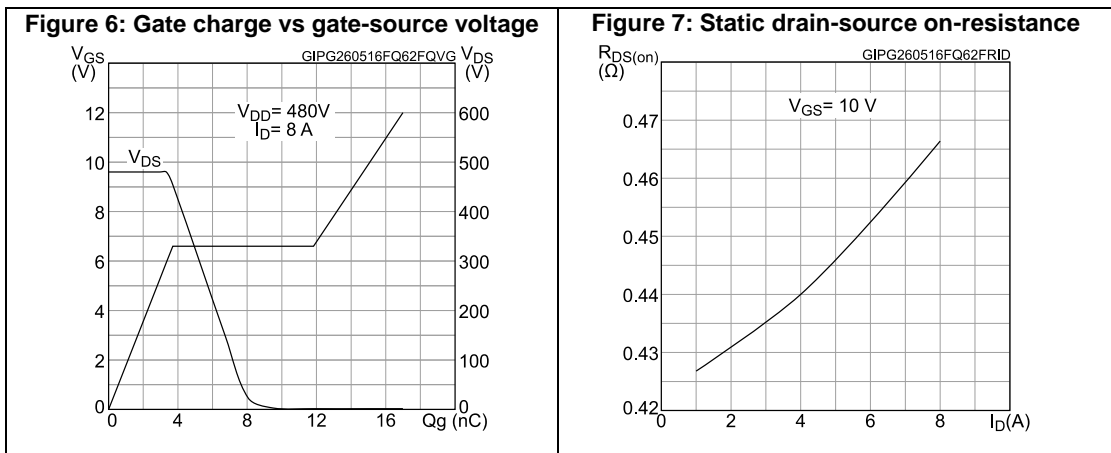
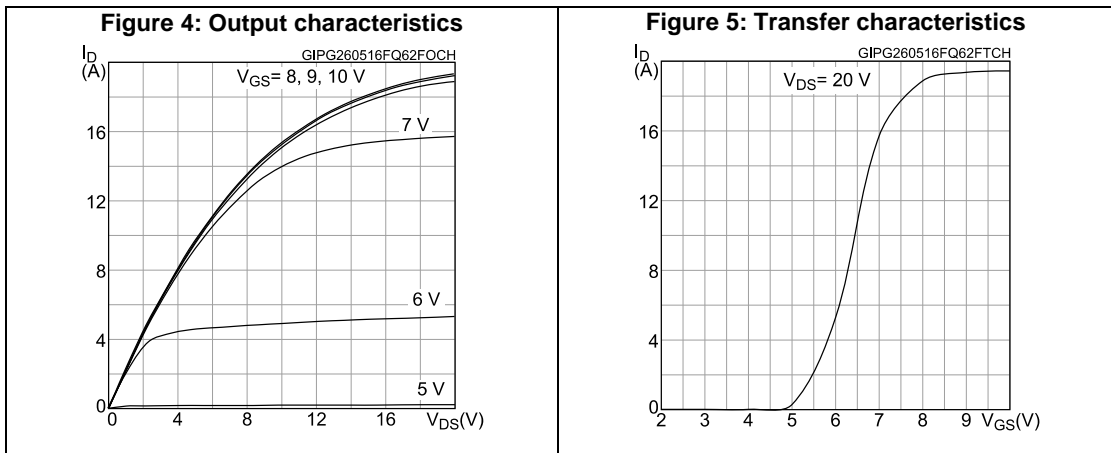
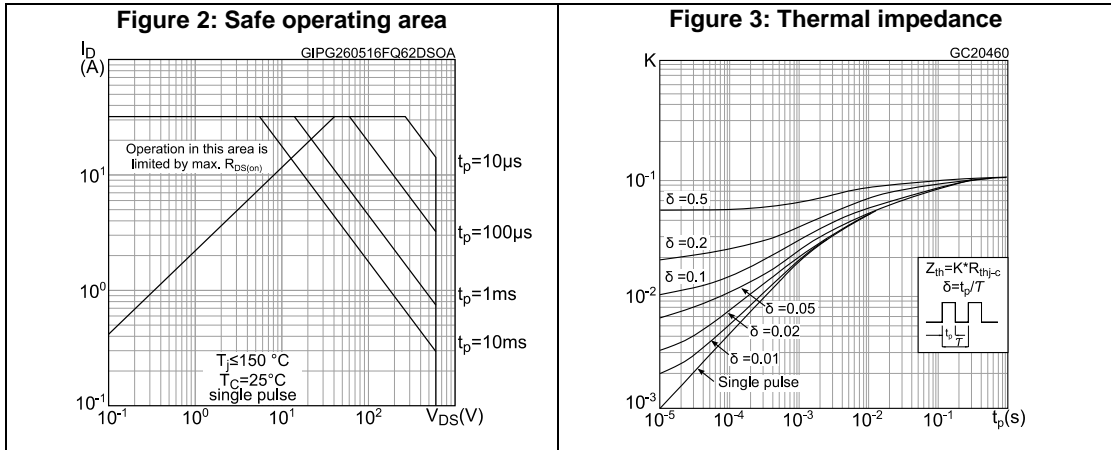

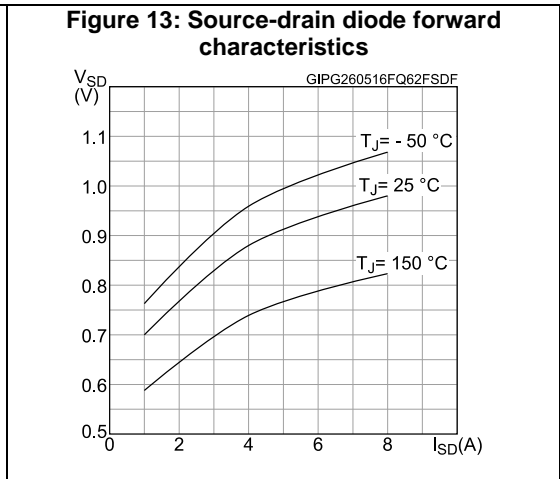
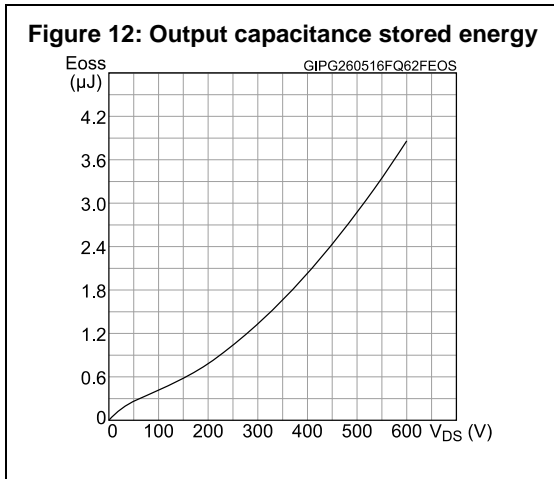
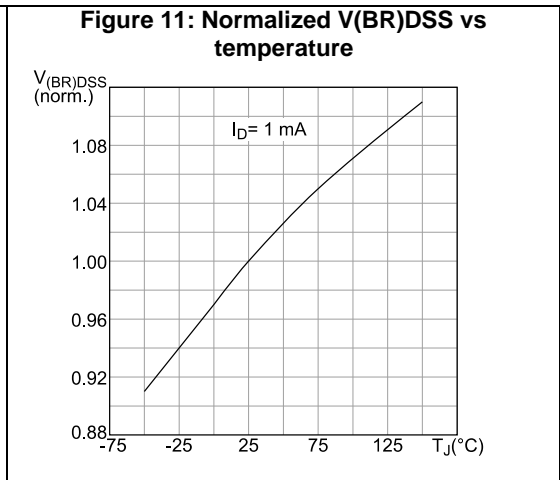
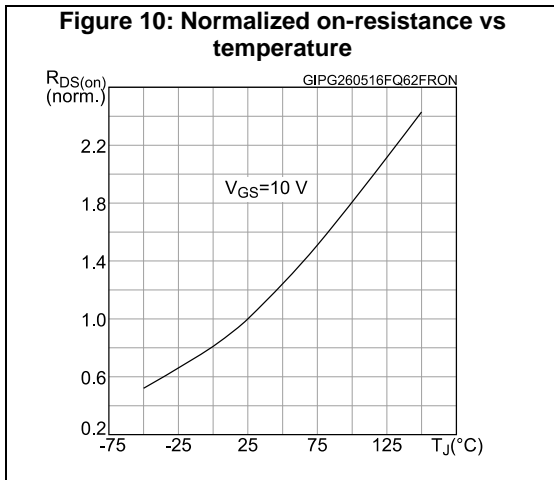
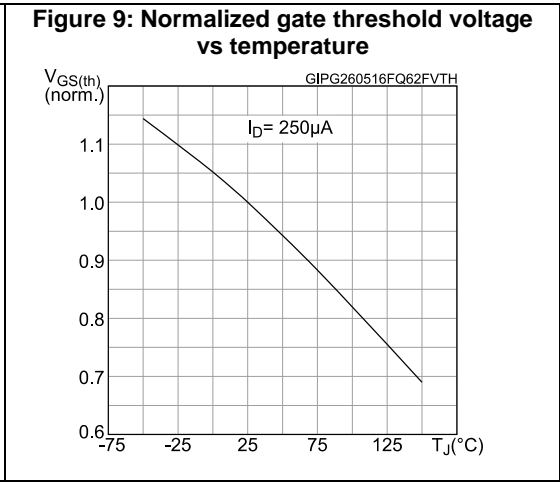
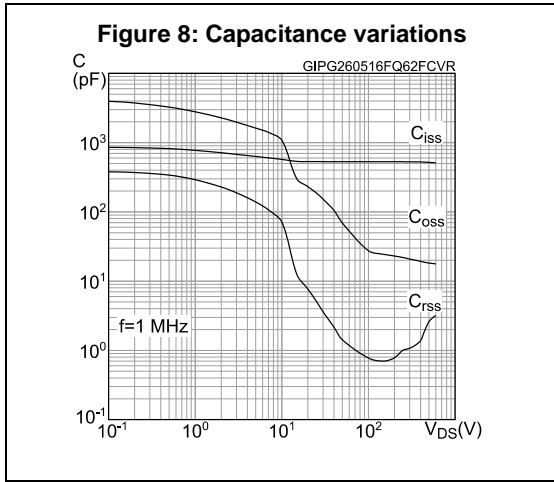

### 3 Test circuits

**Figure 14: Test circuit for resistive load switching times**

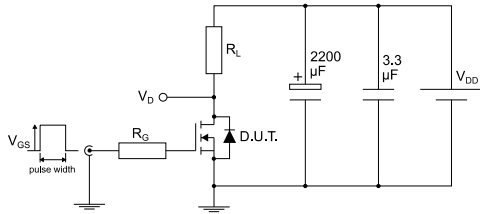

AM01468v1

**Figure 15: Test circuit for gate charge behavior**

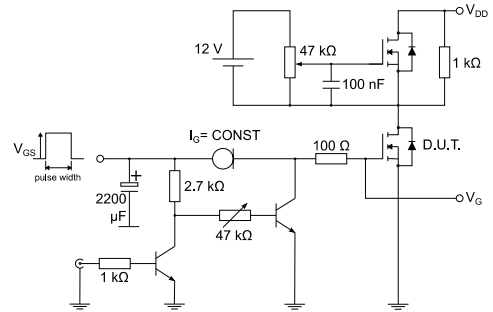

AM01469v1

**Figure 16: Test circuit for inductive load switching and diode recovery times**

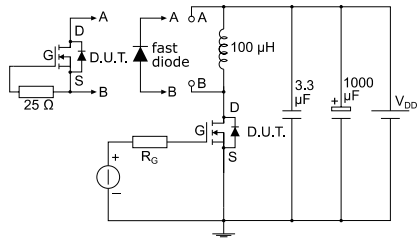

AM01470v1

**Figure 17: Unclamped inductive load test circuit**

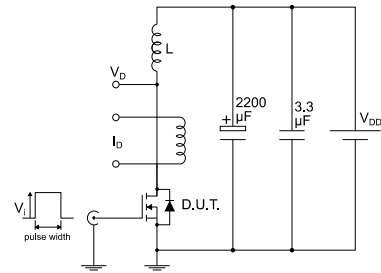

AM01471v1

**Figure 18: Unclamped inductive waveform**

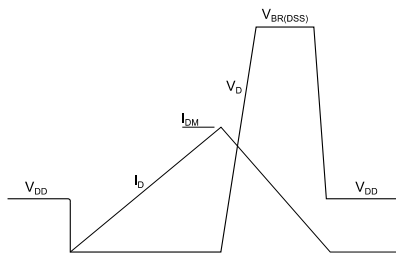

AM01472v1

**Figure 19: Switching time waveform**

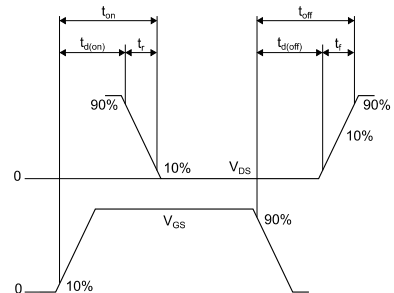

AM01473v1



## 4 Package information

In order to meet environmental requirements, ST offers these devices in different grades of ECOPACK® packages, depending on their level of environmental compliance. ECOPACK® specifications, grade definitions and product status are available at: [www.st.com](http://www.st.com). ECOPACK® is an ST trademark.

### 4.1 DPAK (TO-252) type A package information

Figure 20: DPAK (TO-252) type A package outline

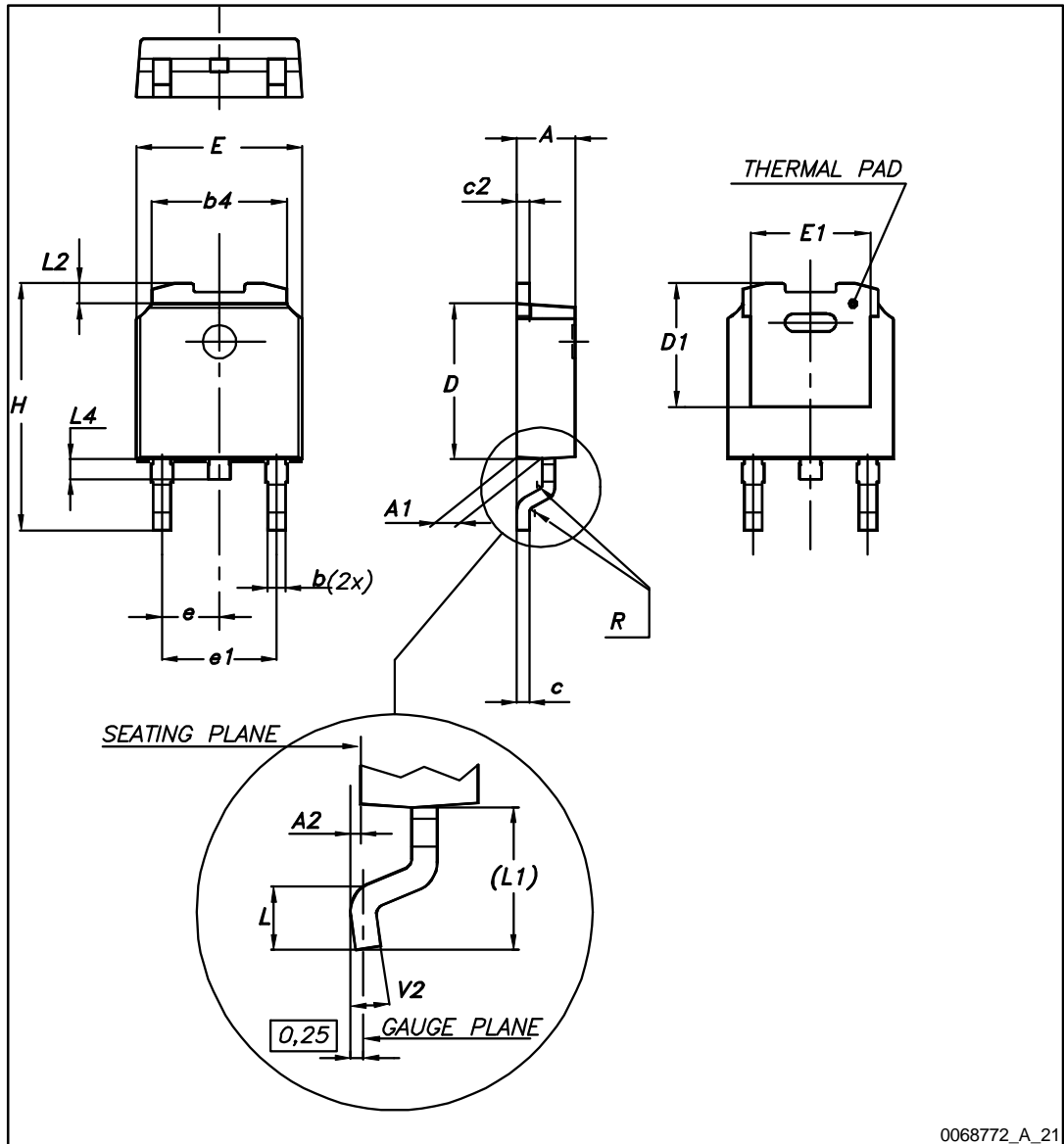
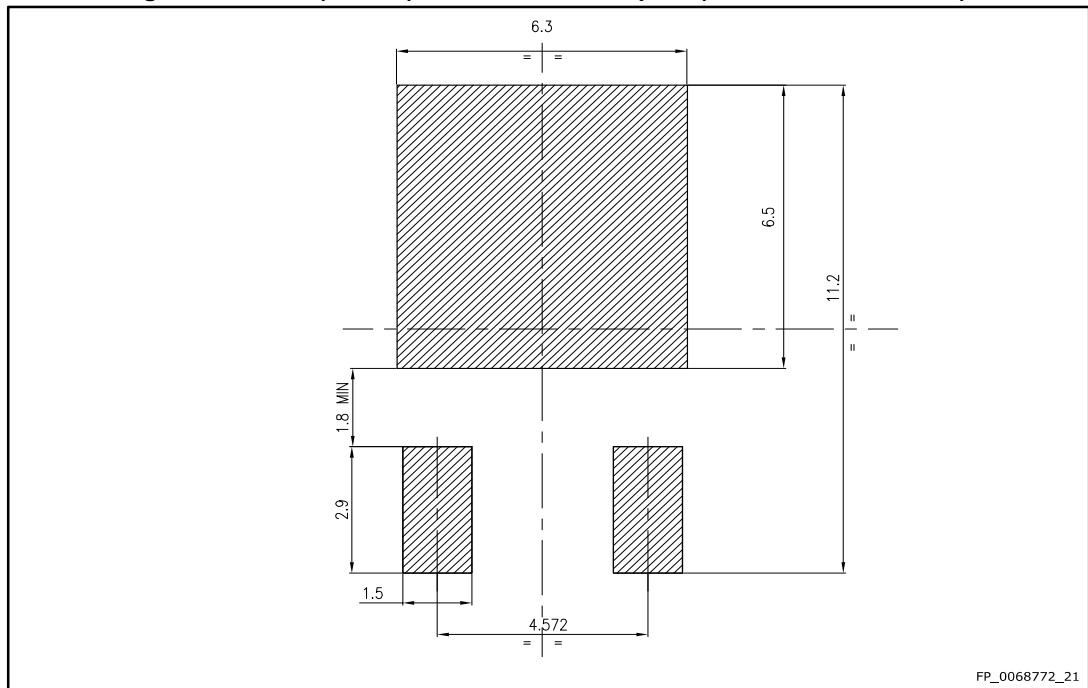

Table 10: DPAK (TO-252) type A mechanical data

Dim.	mm		
	Min.	Typ.	Max.
A	2.20		2.40
A1	0.90		1.10
A2	0.03		0.23
b	0.64		0.90
b4	5.20		5.40
c	0.45		0.60
c2	0.48		0.60
D	6.00		6.20
D1	4.95	5.10	5.25
E	6.40		6.60
E1	4.60	4.70	4.80
e	2.16	2.28	2.40
e1	4.40		4.60
H	9.35		10.10
L	1.00		1.50
(L1)	2.60	2.80	3.00
L2	0.65	0.80	0.95
L4	0.60		1.00
R		0.20	
V2	0°		8°

Figure 21: DPAK (TO-252) recommended footprint (dimensions are in mm)



FP\_0068772\_21

### 4.2 DPAK (TO-252) packing information

Figure 22: DPAK (TO-252) tape outline

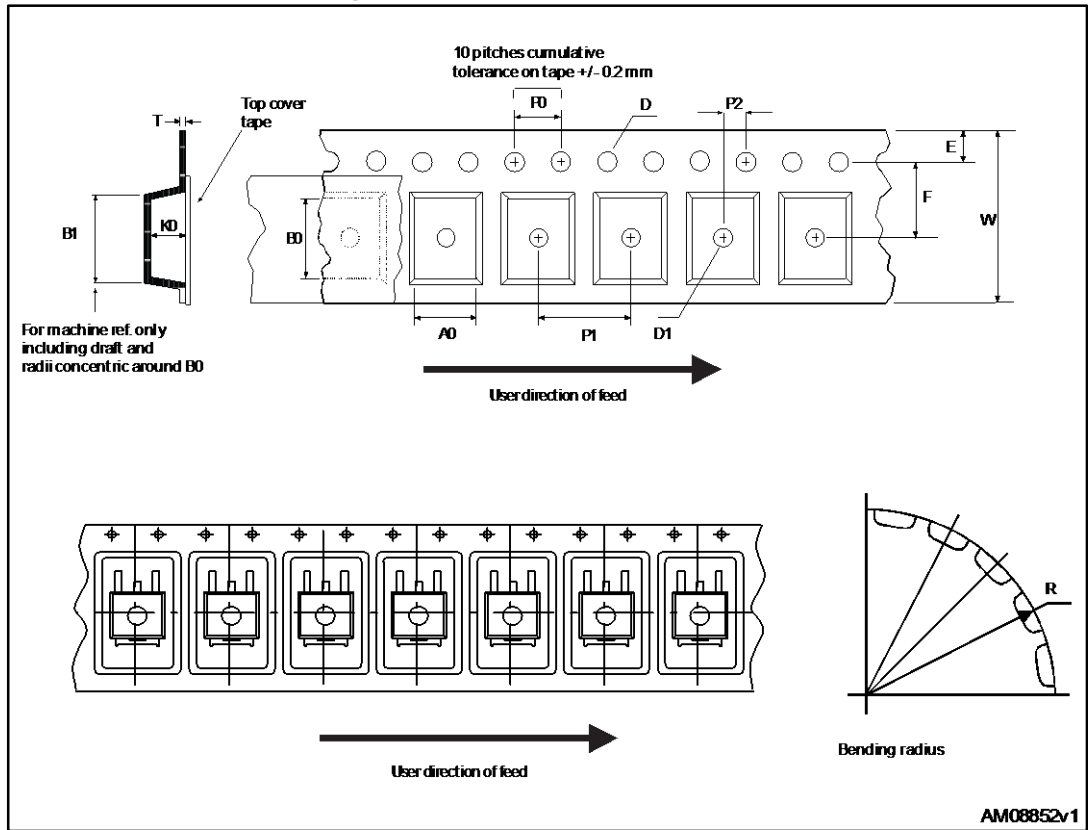

Figure 23: DPAK (TO-252) reel outline

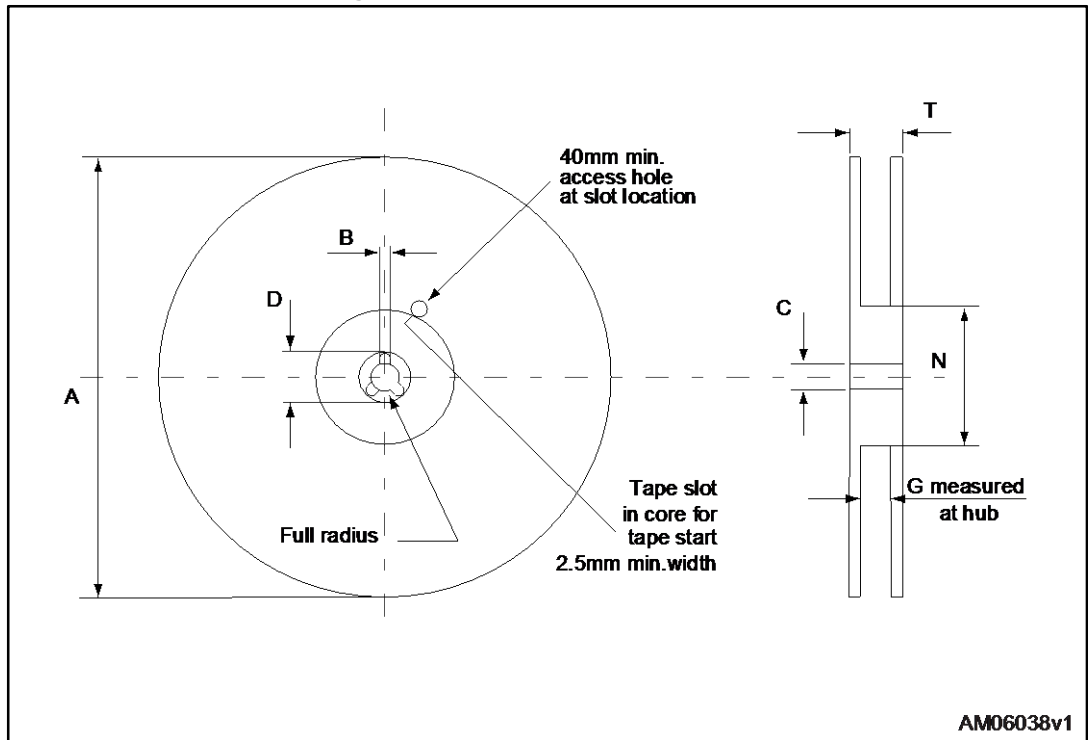

Table 11: DPAK (TO-252) tape and reel mechanical data

Tape			Reel		
Dim.	mm		Dim.	mm	
	Min.	Max.		Min.	Max.
A0	6.8	7	A		330
B0	10.4	10.6	B	1.5	
B1		12.1	C	12.8	13.2
D	1.5	1.6	D	20.2	
D1	1.5		G	16.4	18.4
E	1.65	1.85	N	50	
F	7.4	7.6	T		22.4
K0	2.55	2.75			
P0	3.9	4.1	Base qty.		2500
P1	7.9	8.1	Bulk qty.		2500
P2	1.9	2.1			
R	40				
T	0.25	0.35			
W	15.7	16.3			

## 5 Revision history

Table 12: Document revision history

Date	Revision	Changes
17-Jun-2016	1	First release.

**IMPORTANT NOTICE – PLEASE READ CAREFULLY**

STMicroelectronics NV and its subsidiaries ("ST") reserve the right to make changes, corrections, enhancements, modifications, and improvements to ST products and/or to this document at any time without notice. Purchasers should obtain the latest relevant information on ST products before placing orders. ST products are sold pursuant to ST's terms and conditions of sale in place at the time of order acknowledgement.

Purchasers are solely responsible for the choice, selection, and use of ST products and ST assumes no liability for application assistance or the design of Purchasers' products.

No license, express or implied, to any intellectual property right is granted by ST herein.

Resale of ST products with provisions different from the information set forth herein shall void any warranty granted by ST for such product.

ST and the ST logo are trademarks of ST. All other product or service names are the property of their respective owners.

Information in this document supersedes and replaces information previously supplied in any prior versions of this document.

© 2016 STMicroelectronics – All rights reserved