

N-channel 600 V, 0.57 Ω typ., 8 A, FDmesh™ II
Power MOSFETs in DPAK, TO-220FP and TO-220 packages

Datasheet - production data

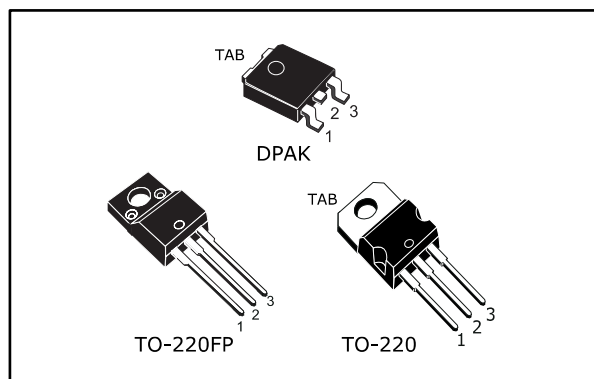
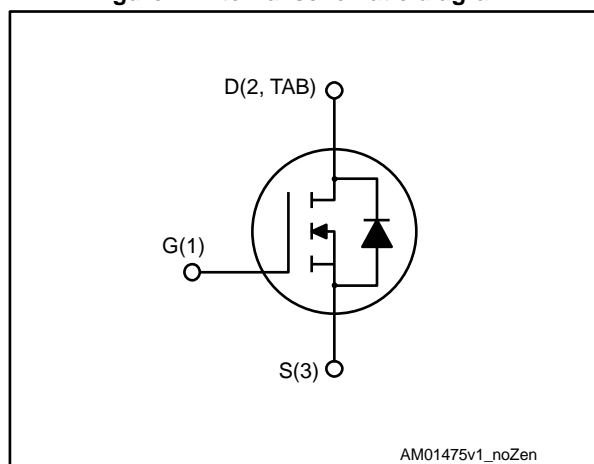

Figure 1: Internal schematic diagram



Features

Order code	V _{DS} @ T _{jmax.}	R _{DS(on)} max.	I _D	P _{TOT}
STD10NM60ND	650 V	0.60 Ω	8 A	70 W
STF10NM60ND				25 W
STP10NM60ND				70 W

- Fast-recovery body diode
- Low gate charge and input capacitance
- Low on-resistance R_{DS(on)}
- 100% avalanche tested
- High dv/dt ruggedness

Applications

- Switching applications

Description

These FDmesh™ II Power MOSFETs with fast-recovery body diode are produced using MDmesh™ II technology. Utilizing a new strip-layout vertical structure, these devices feature low on-resistance and superior switching performance. They are ideal for bridge topologies and ZVS phase-shift converters.

Table 1: Device summary

Order code	Marking	Package	Packing
STD10NM60ND	10NM60ND	DPAK	Tape and reel
STF10NM60ND		TO-220FP	Tube
STP10NM60ND		TO-220	

Contents

1 Electrical ratings 3

2 Electrical characteristics 4

 2.1 Electrical characteristics (curves) 6

3 Test circuits 9

4 Package information 10

 4.1 DPAK (TO-252) type A package information..... 10

 4.2 DPAK (TO-252) type E package information..... 12

 4.3 TO-220FP package information 14

 4.4 TO-220 package information..... 16

 4.5 DPAK (TO-252) packing information 18

5 Revision history 20



1 Electrical ratings

Table 2: Absolute maximum ratings

Symbol	Parameter	Value			Unit
		DPAK	TO-220FP	TO-220	
V_{DS}	Drain-source voltage	600			V
V_{GS}	Gate-source voltage	±25			V
I_D	Drain current (continuous) at $T_C = 25\text{ °C}$	8	8 ⁽¹⁾	8	A
I_D	Drain current (continuous) at $T_C = 100\text{ °C}$	5	5 ⁽¹⁾	5	A
I_{DM} ⁽²⁾	Drain current (pulsed)	32			A
P_{TOT}	Total dissipation at $T_C = 25\text{ °C}$	70	25	70	W
dv/dt ⁽³⁾	Peak diode recovery voltage slope	40			V/ns
V_{ISO}	Insulation withstand voltage (RMS) from all three leads to external heat-sink ($t = 1\text{ s}$; $T_C = 25\text{ °C}$)			2500	V
T_{stg}	Storage temperature range	- 55 to 150			°C
T_j	Operating junction temperature range				

Notes:

⁽¹⁾Limited by maximum junction temperature.

⁽²⁾Pulse width limited by safe operating area.

⁽³⁾ $I_{SD} \leq 8\text{ A}$, $di/dt \leq 400\text{ A}/\mu\text{s}$; $V_{DS(peak)} < V_{(BR)DSS}$, $V_{DD} = 80\% V_{(BR)DSS}$.

Table 3: Thermal data

Symbol	Parameter	Value			Unit
		DPAK	TO-220FP	TO-220	
$R_{thj-case}$	Thermal resistance junction-case	1.79	5	1.79	°C/W
$R_{thj-pcb}$	Thermal resistance junction-pcb ⁽¹⁾	50			°C/W
$R_{thj-amb}$	Thermal resistance junction-ambient		62.5		°C/W

Notes:

⁽¹⁾When mounted on 1 inch² FR-4, 2 Oz copper board.

Table 4: Avalanche characteristics

Symbol	Parameter	Value	Unit
I_{AS} ⁽¹⁾	Single pulse avalanche current	2.5	A
E_{AS} ⁽²⁾	Single pulse avalanche energy	130	mJ

Notes:

⁽¹⁾ Pulse width limited by T_{jmax} .

⁽²⁾ starting $T_j = 25\text{ °C}$, $I_D = I_{AS}$, $V_{DD} = 50\text{ V}$.

2 Electrical characteristics

($T_{\text{case}} = 25\text{ °C}$ unless otherwise specified)

Table 5: Static

Symbol	Parameter	Test conditions	Min.	Typ.	Max.	Unit
$V_{(\text{BR})\text{DSS}}$	Drain-source breakdown voltage	$V_{\text{GS}} = 0\text{ V}$, $I_{\text{D}} = 1\text{ mA}$	600			V
I_{DSS}	Zero gate voltage drain current	$V_{\text{GS}} = 0\text{ V}$, $V_{\text{DS}} = 600\text{ V}$			1	μA
		$V_{\text{GS}} = 0\text{ V}$, $V_{\text{DS}} = 600\text{ V}$, $T_{\text{C}} = 125\text{ °C}$ ⁽¹⁾			100	
I_{GSS}	Gate-body leakage current	$V_{\text{DS}} = 0\text{ V}$, $V_{\text{GS}} = \pm 25\text{ V}$			± 100	nA
$V_{\text{GS}(\text{th})}$	Gate threshold voltage	$V_{\text{DS}} = V_{\text{GS}}$, $I_{\text{D}} = 250\text{ }\mu\text{A}$	3	4	5	V
$R_{\text{DS}(\text{on})}$	Static drain-source on-resistance	$V_{\text{GS}} = 10\text{ V}$, $I_{\text{D}} = 4\text{ A}$		0.57	0.60	Ω

Notes:

⁽¹⁾Defined by design, not subject to production test.

Table 6: Dynamic

Symbol	Parameter	Test conditions	Min.	Typ.	Max.	Unit
C_{ISS}	Input capacitance	$V_{\text{DS}} = 50\text{ V}$, $f = 1\text{ MHz}$, $V_{\text{GS}} = 0\text{ V}$	-	577	-	μF
C_{OSS}	Output capacitance		-	32.4	-	
C_{RSS}	Reverse transfer capacitance		-	1.76	-	
$C_{\text{OSS eq.}}^{(1)}$	Equivalent output capacitance	$V_{\text{DS}} = 0\text{ to }480\text{ V}$, $V_{\text{GS}} = 0\text{ V}$	-	138	-	μF
R_{G}	Intrinsic gate resistance	$f = 1\text{ MHz}$, $I_{\text{D}} = 0\text{ A}$	-	6	-	Ω
Q_{g}	Total gate charge	$V_{\text{DD}} = 480\text{ V}$, $I_{\text{D}} = 8\text{ A}$, $V_{\text{GS}} = 0\text{ to }10\text{ V}$ (see Figure 19: "Test circuit for gate charge behavior")	-	20	-	nC
Q_{gs}	Gate-source charge		-	4.3	-	
Q_{gd}	Gate-drain charge		-	11.6	-	

Notes:

⁽¹⁾ $C_{\text{OSS eq.}}$ is defined as a constant equivalent capacitance giving the same charging time as C_{OSS} when V_{DS} increases from 0 to 80% V_{DSS}

Table 7: Switching times

Symbol	Parameter	Test conditions	Min.	Typ.	Max.	Unit
$t_{\text{d}(\text{on})}$	Turn-on delay time	$V_{\text{DD}} = 300\text{ V}$, $I_{\text{D}} = 4\text{ A}$, $R_{\text{G}} = 4.7\text{ }\Omega$, $V_{\text{GS}} = 10\text{ V}$ (see Figure 18: "Test circuit for resistive load switching times" and Figure 23: "Switching time waveform")	-	9.2	-	ns
t_{r}	Rise time		-	10	-	
$t_{\text{d}(\text{off})}$	Turn-off delay time		-	32	-	
t_{f}	Fall time		-	9.8	-	

Table 8: Source-drain diode

Symbol	Parameter	Test conditions	Min.	Typ.	Max.	Unit
I_{SD}	Source-drain current		-		8	A
$I_{SDM}^{(1)}$	Source-drain current (pulsed)		-		32	A
$V_{SD}^{(2)}$	Forward on voltage	$V_{GS} = 0\text{ V}$, $I_{SD} = 8\text{ A}$	-		1.5	V
t_{rr}	Reverse recovery time	$I_{SD} = 8\text{ A}$, $di/dt = 100\text{ A}/\mu\text{s}$, $V_{DD} = 60\text{ V}$ (see <i>Figure 20: "Test circuit for inductive load switching and diode recovery times"</i>)	-	118		ns
Q_{rr}	Reverse recovery charge		-	680		nC
I_{RRM}	Reverse recovery current		-	11		A
t_{rr}	Reverse recovery time	$I_{SD} = 8\text{ A}$, $di/dt = 100\text{ A}/\mu\text{s}$, $V_{DD} = 60\text{ V}$, $T_j = 150\text{ }^\circ\text{C}$ (see <i>Figure 20: "Test circuit for inductive load switching and diode recovery times"</i>)	-	150		ns
Q_{rr}	Reverse recovery charge		-	918		nC
I_{RRM}	Reverse recovery current		-	12		A

Notes:

- (1) Pulse width is limited by safe operating area.
(2) Pulse test: pulse duration = 300 μs , duty cycle 1.5%.

2.1 Electrical characteristics (curves)

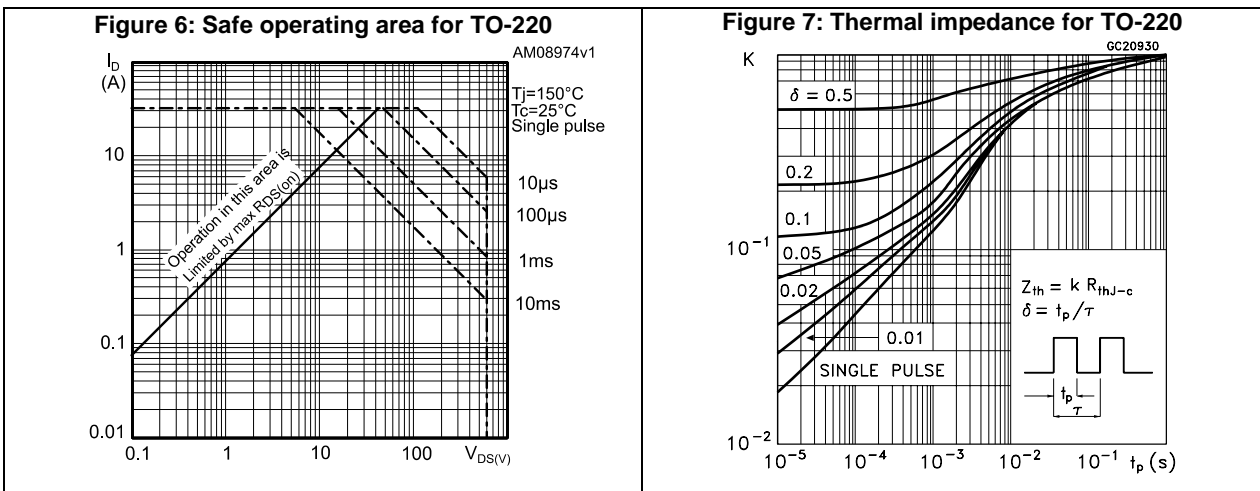
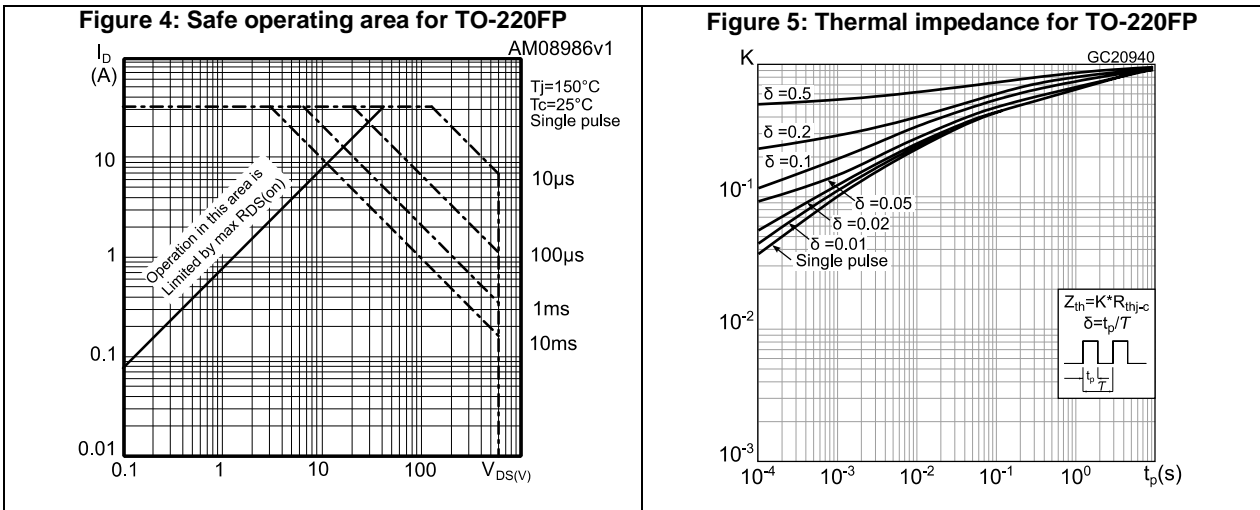
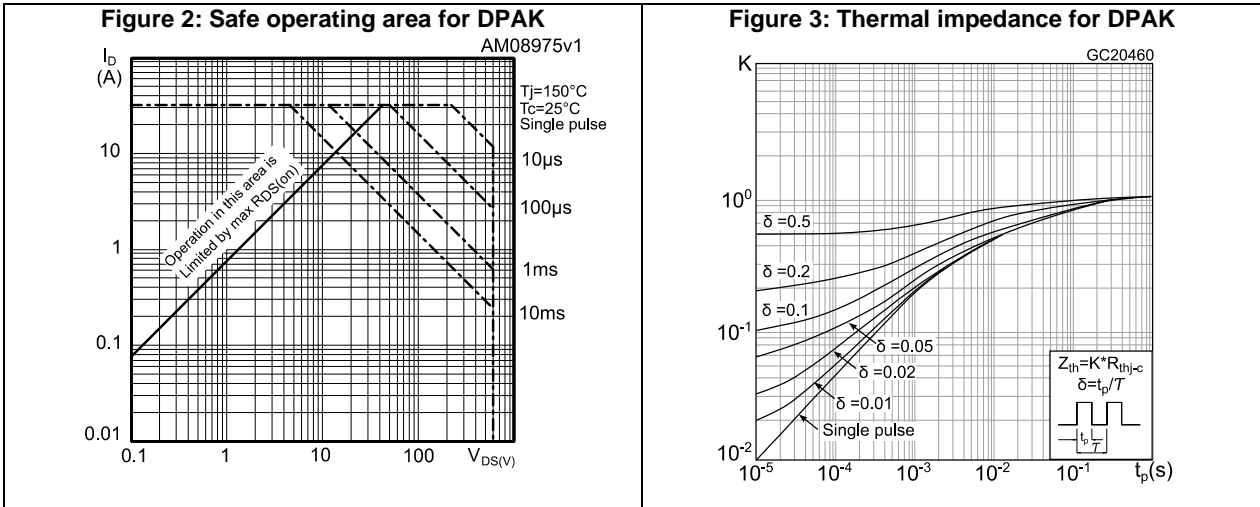

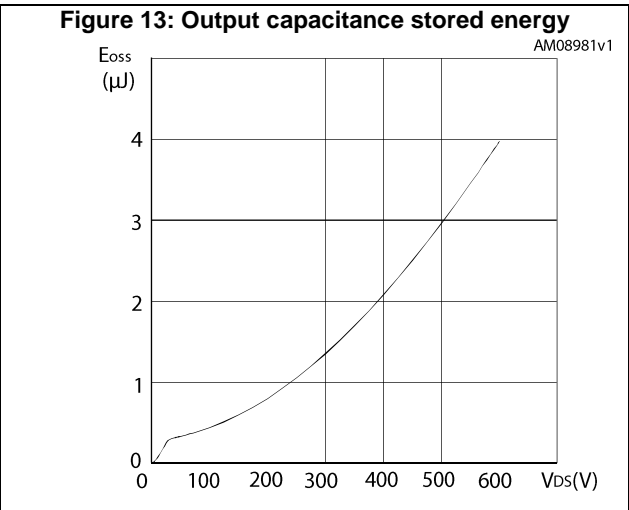
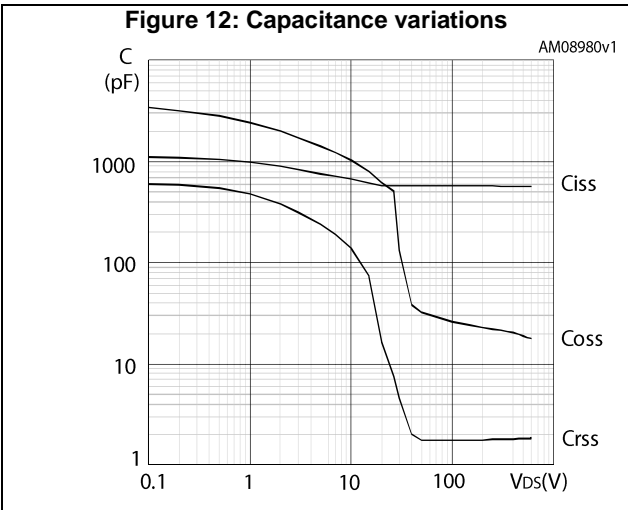
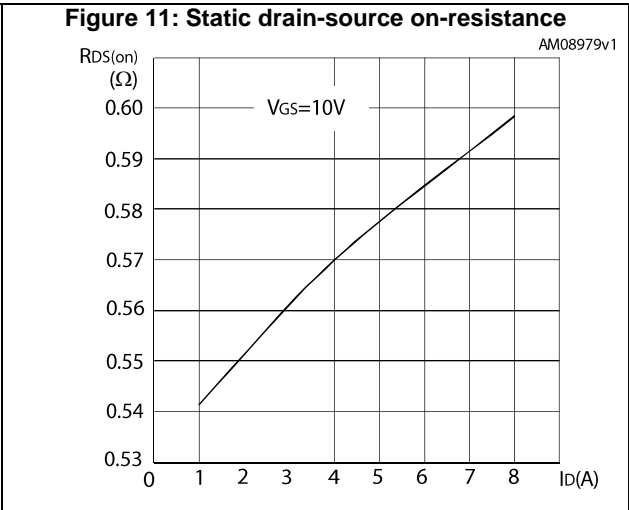
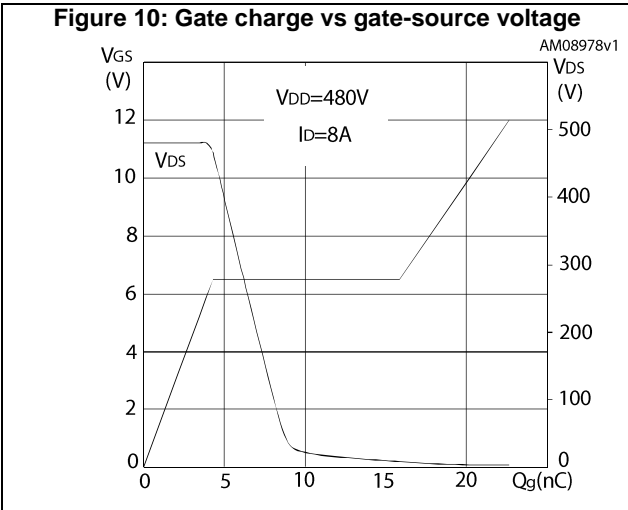
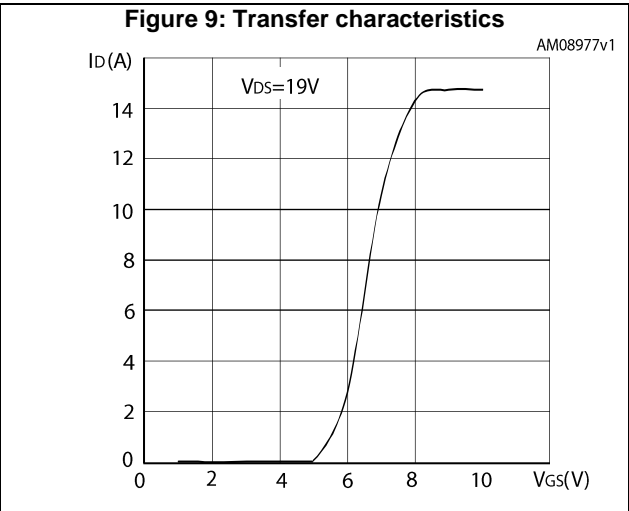
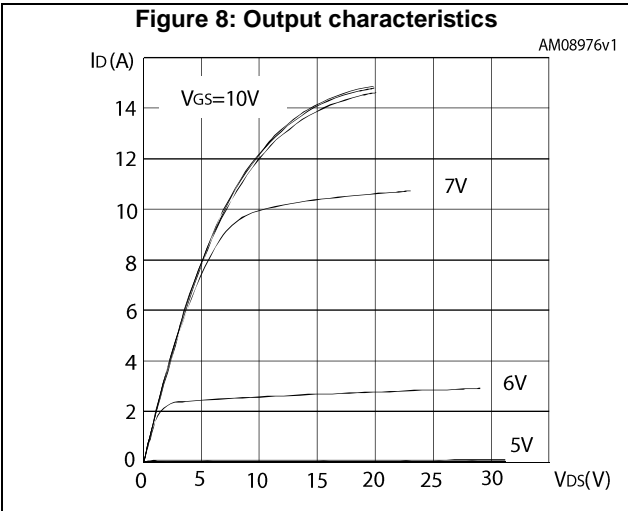

Figure 14: Normalized gate threshold voltage vs temperature

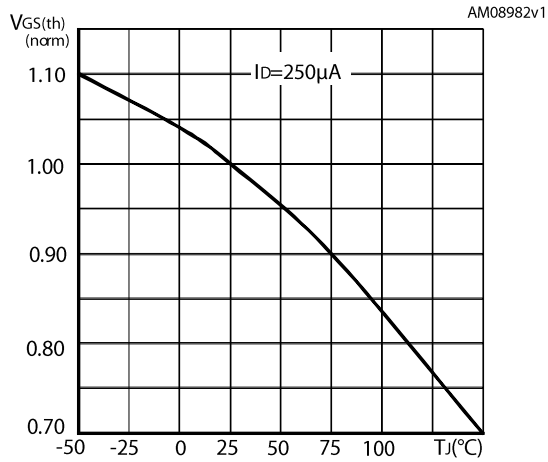

Figure 15: Normalized on-resistance vs temperature

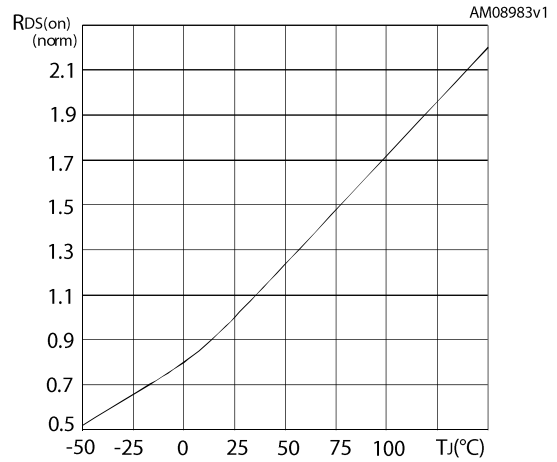

Figure 16: Normalized V_{(BR)DSS} vs temperature

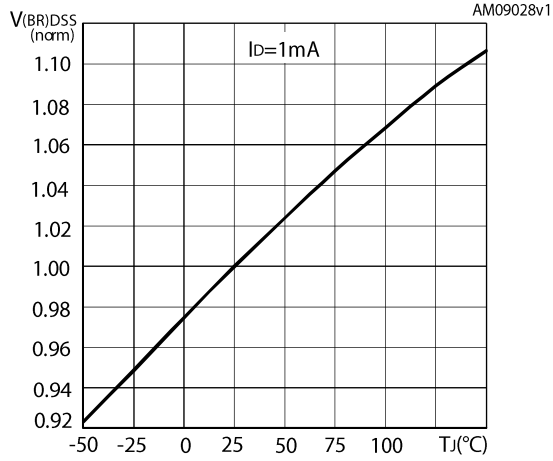
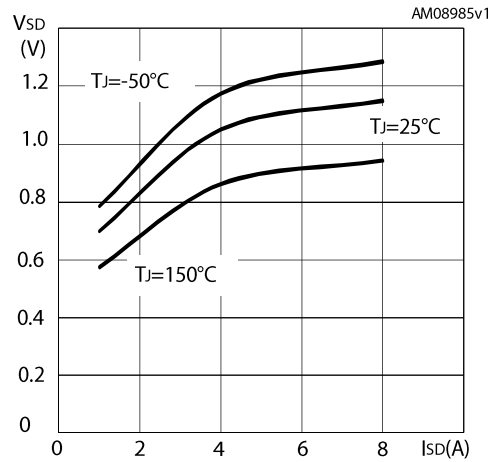

Figure 17: Source-drain diode forward characteristics



3 Test circuits

Figure 18: Test circuit for resistive load switching times



AM01468v1

Figure 19: Test circuit for gate charge behavior



AM01469v1

Figure 20: Test circuit for inductive load switching and diode recovery times

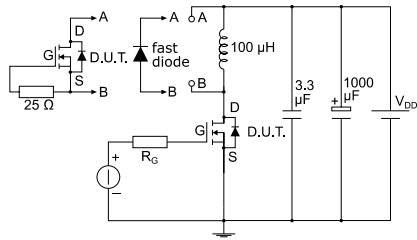

AM01470v1

Figure 21: Unclamped inductive load test circuit

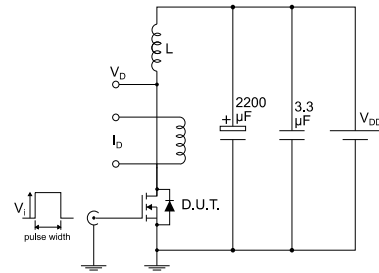

AM01471v1

Figure 22: Unclamped inductive waveform

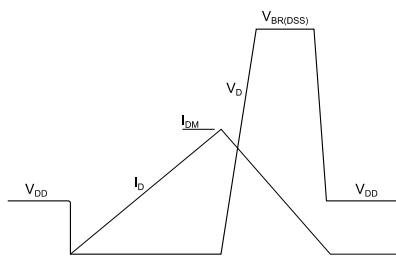

AM01472v1

Figure 23: Switching time waveform

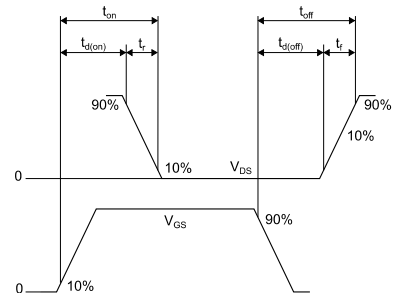

AM01473v1

4 Package information

In order to meet environmental requirements, ST offers these devices in different grades of ECOPACK® packages, depending on their level of environmental compliance. ECOPACK® specifications, grade definitions and product status are available at: www.st.com. ECOPACK® is an ST trademark.

4.1 DPAK (TO-252) type A package information

Figure 24: DPAK (TO-252) type A package outline

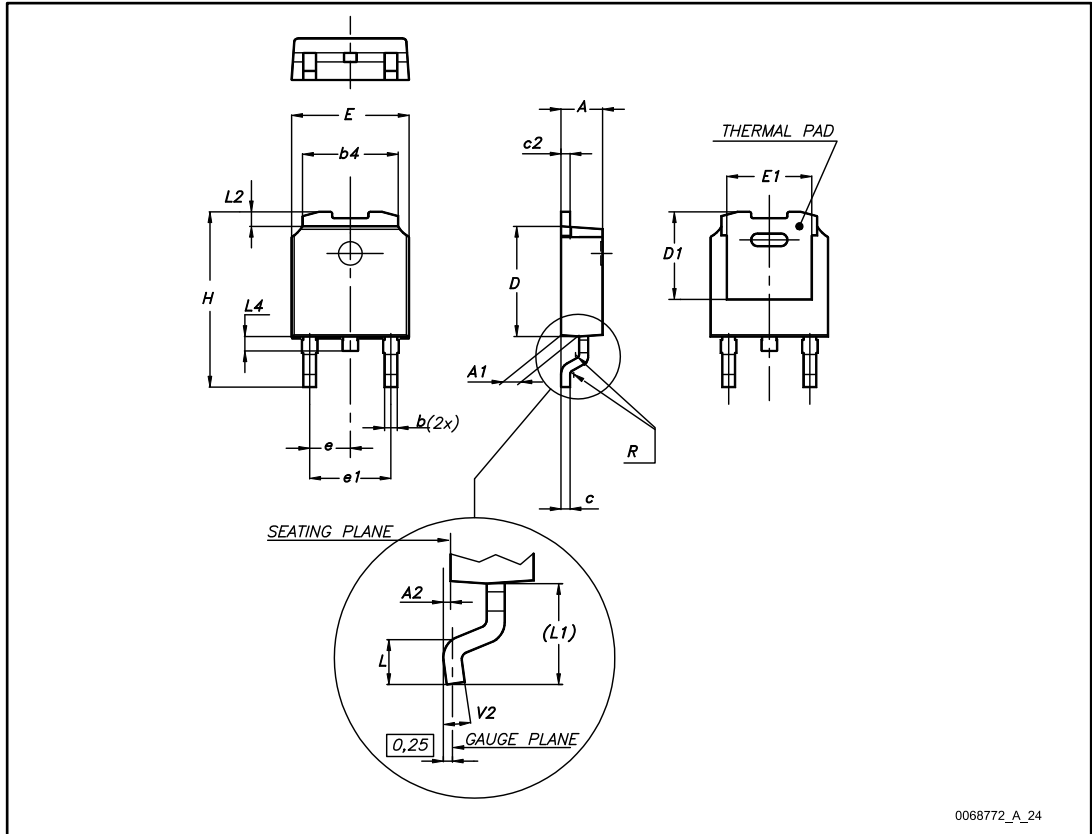

Table 9: DPAK (TO-252) type A mechanical data

Dim.	mm		
	Min.	Typ.	Max.
A	2.20		2.40
A1	0.90		1.10
A2	0.03		0.23
b	0.64		0.90
b4	5.20		5.40
c	0.45		0.60
c2	0.48		0.60
D	6.00		6.20
D1	4.95	5.10	5.25
E	6.40		6.60
E1	4.60	4.70	4.80
e	2.16	2.28	2.40
e1	4.40		4.60
H	9.35		10.10
L	1.00		1.50
(L1)	2.60	2.80	3.00
L2	0.65	0.80	0.95
L4	0.60		1.00
R		0.20	
V2	0°		8°

4.2 DPAK (TO-252) type E package information

Figure 25: DPAK (TO-252) type E package outline

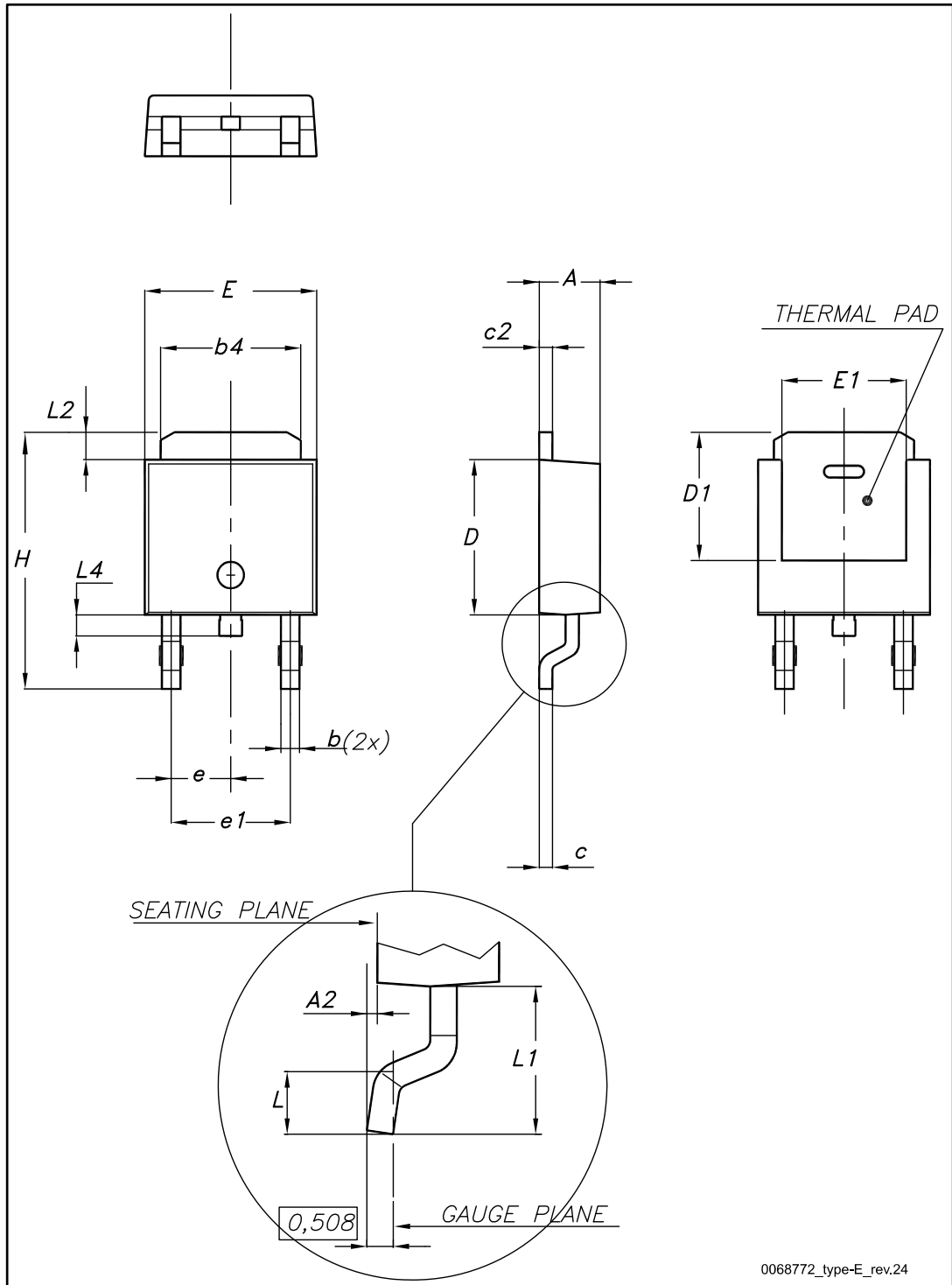
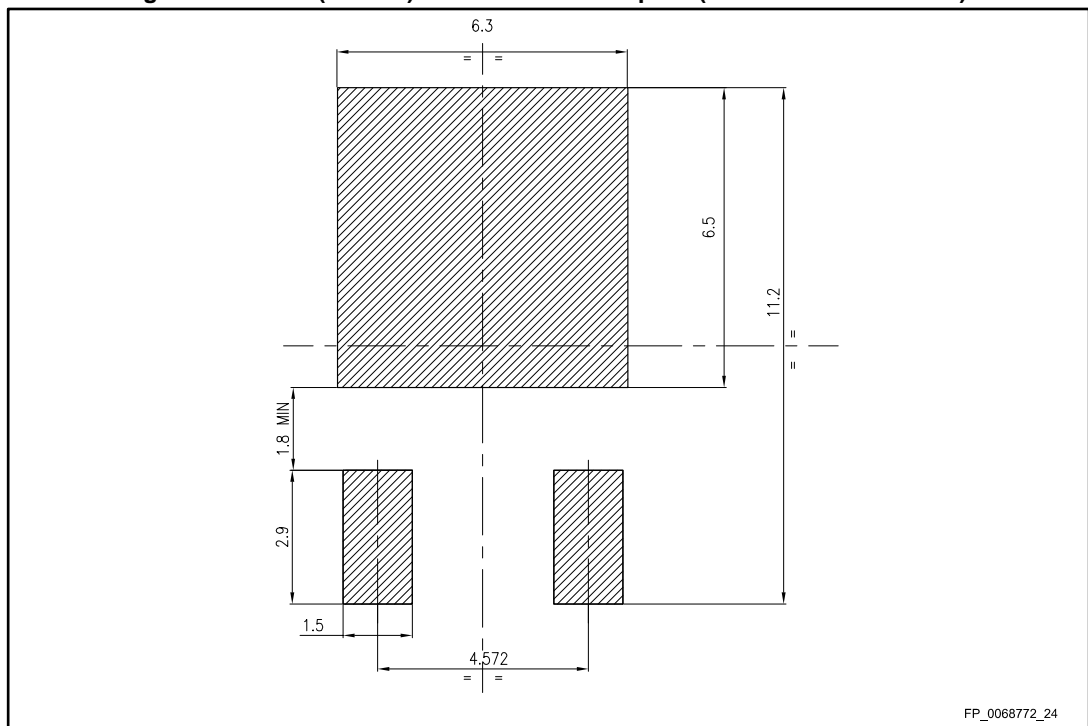

Table 10: DPAK (TO-252) type E mechanical data

Dim.	mm		
	Min.	Typ.	Max.
A	2.18		2.39
A2			0.13
b	0.65		0.884
b4	4.95		5.46
c	0.46		0.61
c2	0.46		0.60
D	5.97		6.22
D1	5.21		
E	6.35		6.73
E1	4.32		
e		2.286	
e1		4.572	
H	9.94		10.34
L	1.50		1.78
L1		2.74	
L2	0.89		1.27
L4			1.02

Figure 26: DPAK (TO-252) recommended footprint (dimensions are in mm)



4.3 TO-220FP package information

Figure 27: TO-220FP package outline



7012510_Rev_12_B

Table 11: TO-220FP package mechanical data

Dim.	mm		
	Min.	Typ.	Max.
A	4.4		4.6
B	2.5		2.7
D	2.5		2.75
E	0.45		0.7
F	0.75		1
F1	1.15		1.70
F2	1.15		1.70
G	4.95		5.2
G1	2.4		2.7
H	10		10.4
L2		16	
L3	28.6		30.6
L4	9.8		10.6
L5	2.9		3.6
L6	15.9		16.4
L7	9		9.3
Dia	3		3.2

4.4 TO-220 package information

Figure 28: TO-220 type A package outline

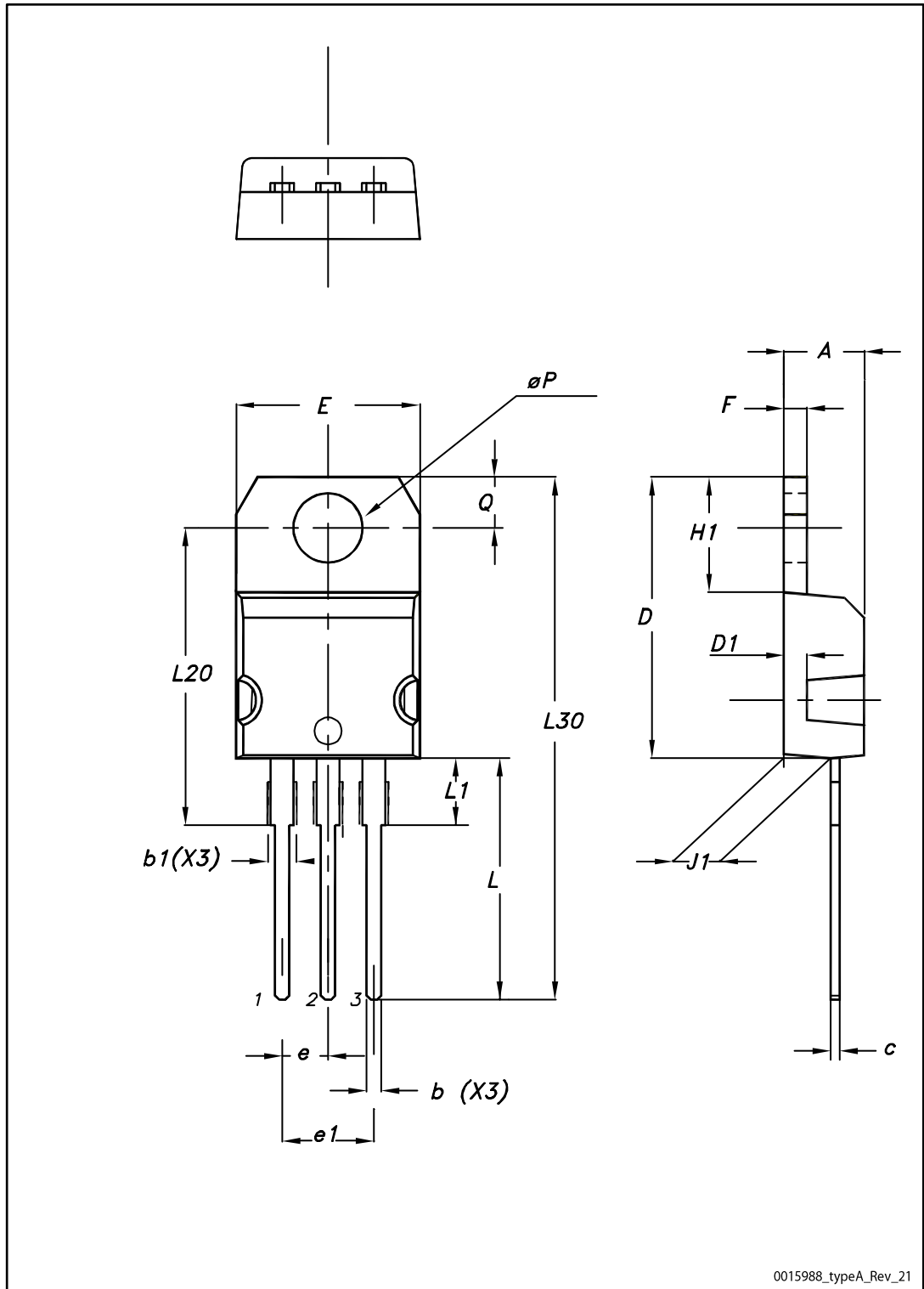

0015988_typeA_Rev_21

Table 12: TO-220 type A package mechanical data

Dim.	mm		
	Min.	Typ.	Max.
A	4.40		4.60
b	0.61		0.88
b1	1.14		1.55
c	0.48		0.70
D	15.25		15.75
D1		1.27	
E	10.00		10.40
e	2.40		2.70
e1	4.95		5.15
F	1.23		1.32
H1	6.20		6.60
J1	2.40		2.72
L	13.00		14.00
L1	3.50		3.93
L20		16.40	
L30		28.90	
øP	3.75		3.85
Q	2.65		2.95

4.5 DPAK (TO-252) packing information

Figure 29: DPAK (TO-252) tape outline

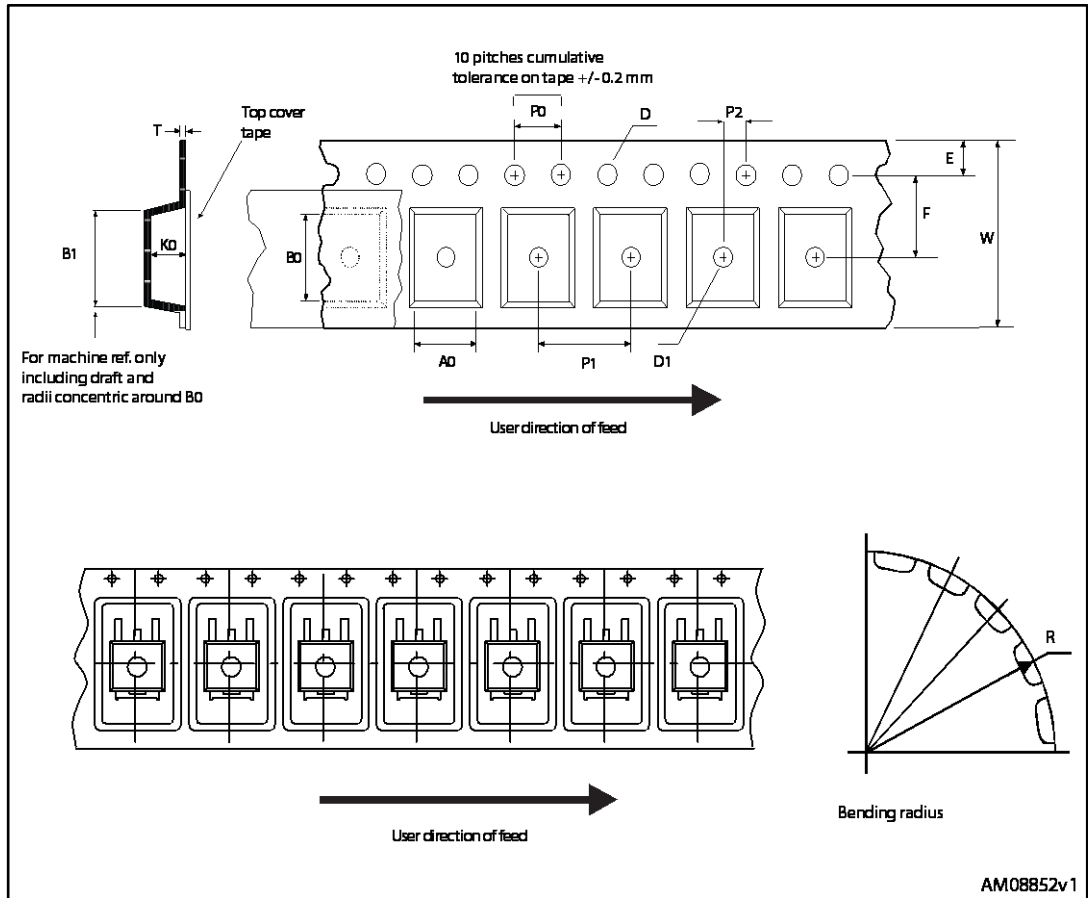

Figure 30: DPAK (TO-252) reel outline

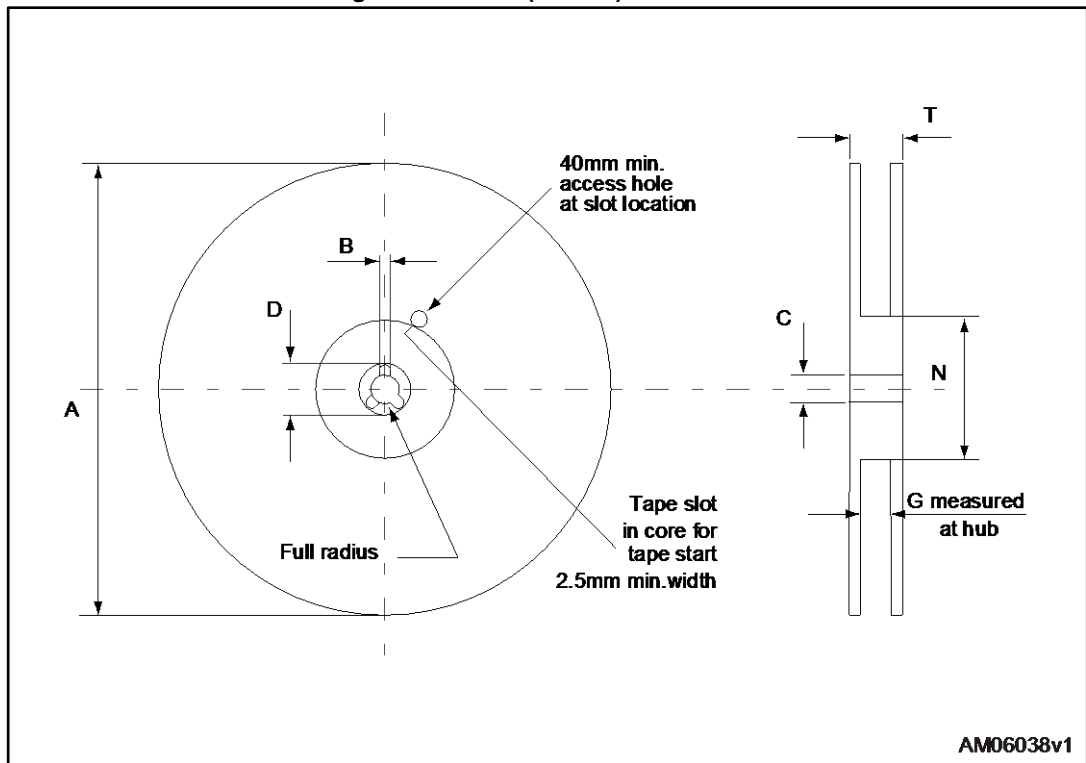

Table 13: DPAK (TO-252) tape and reel mechanical data

Tape			Reel		
Dim.	mm		Dim.	mm	
	Min.	Max.		Min.	Max.
A0	6.8	7	A		330
B0	10.4	10.6	B	1.5	
B1		12.1	C	12.8	13.2
D	1.5	1.6	D	20.2	
D1	1.5		G	16.4	18.4
E	1.65	1.85	N	50	
F	7.4	7.6	T		22.4
K0	2.55	2.75			
P0	3.9	4.1	Base qty.		2500
P1	7.9	8.1	Bulk qty.		2500
P2	1.9	2.1			
R	40				
T	0.25	0.35			
W	15.7	16.3			

5 Revision history

Table 14: Document revision history

Date	Revision	Changes
10-Feb-2011	1	First release.
17-Nov-2011	2	Updated features in table and description in cover page. Updated <i>Table 2: Absolute maximum ratings</i> , <i>Table 5: On /off states</i> , <i>Table 15: Normalized on resistance vs temperature</i> , <i>Figure 17:</i> <i>Normalized V_{DS} vs temperature</i> and <i>Section 4: Package mechanical</i> <i>data</i> .
03-Nov-2017	3	Modified <i>Table 3: "Thermal data"</i> . Modified <i>Section 4: "Package information"</i> . Minor text changes.

IMPORTANT NOTICE – PLEASE READ CAREFULLY

STMicroelectronics NV and its subsidiaries ("ST") reserve the right to make changes, corrections, enhancements, modifications, and improvements to ST products and/or to this document at any time without notice. Purchasers should obtain the latest relevant information on ST products before placing orders. ST products are sold pursuant to ST's terms and conditions of sale in place at the time of order acknowledgement.

Purchasers are solely responsible for the choice, selection, and use of ST products and ST assumes no liability for application assistance or the design of Purchasers' products.

No license, express or implied, to any intellectual property right is granted by ST herein.

Resale of ST products with provisions different from the information set forth herein shall void any warranty granted by ST for such product.

ST and the ST logo are trademarks of ST. All other product or service names are the property of their respective owners.

Information in this document supersedes and replaces information previously supplied in any prior versions of this document.

© 2017 STMicroelectronics – All rights reserved