

Silicon NPN Power Transistors

2SC3277

DESCRIPTION

- With TO-3PN package
- High voltage ,high current
- Fast switching speed
- Wide area of safe operation

APPLICATIONS

- 400V/10A switching regulator applications

PINNING

PIN	DESCRIPTION
1	Base
2	Collector;connected to mounting base
3	Emitter

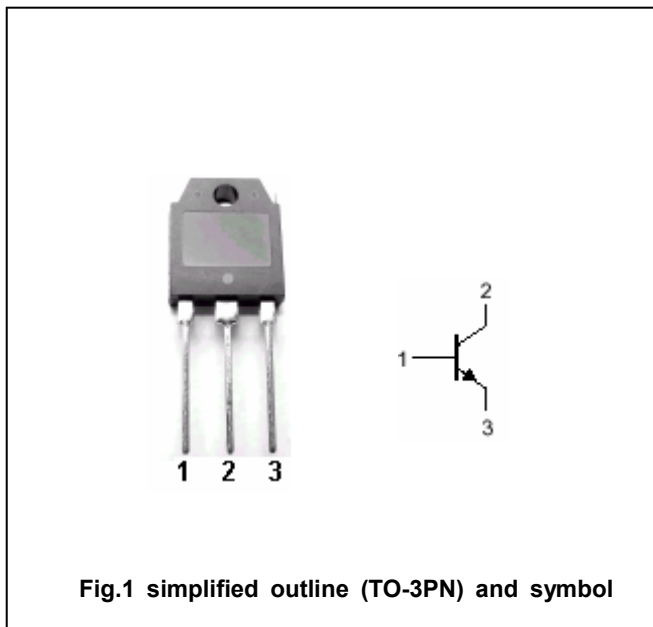

Absolute maximum ratings (Ta=25°C)

SYMBOL	PARAMETER	CONDITIONS	VALUE	UNIT
V <sub>CBO</sub>	Collector-base voltage	Open emitter	500	V
V <sub>CEO</sub>	Collector-emitter voltage	Open base	400	V
V <sub>EBO</sub>	Emitter-base voltage	Open collector	7	V
I <sub>C</sub>	Collector current		10	A
I <sub>CM</sub>	Collector current-peak		20	A
P <sub>C</sub>	Collector power dissipation	T <sub>C</sub> =25°C	90	W
T <sub>j</sub>	Junction temperature		150	°C
T <sub>stg</sub>	Storage temperature		-55~150	°C

## Silicon NPN Power Transistors

2SC3277

## CHARACTERISTICS

T<sub>j</sub>=25°C unless otherwise specified

SYMBOL	PARAMETER	CONDITIONS	MIN	TYP.	MAX	UNIT
V <sub>(BR)CEO</sub>	Collector-emitter breakdown voltage	I <sub>C</sub> =5mA ; R <sub>BE</sub> =∞	400			V
V <sub>(BR)CBO</sub>	Collector-base breakdown voltage	I <sub>C</sub> =1mA ; I <sub>E</sub> =0	500			V
V <sub>(BR)EBO</sub>	Emitter-base breakdown voltage	I <sub>E</sub> =1mA ; I <sub>C</sub> =0	7			V
V <sub>CEsat</sub>	Collector-emitter saturation voltage	I <sub>C</sub> =6A ; I <sub>B</sub> =1.2A			1.0	V
V <sub>BEsat</sub>	Base-emitter saturation voltage	I <sub>C</sub> =6A ; I <sub>B</sub> =1.2A			1.5	V
I <sub>CBO</sub>	Collector cut-off current	V <sub>CB</sub> =400V ; I <sub>E</sub> =0			10	μA
I <sub>EBO</sub>	Emitter cut-off current	V <sub>EB</sub> =5V ; I <sub>C</sub> =0			10	μA
h <sub>FE-1</sub>	DC current gain	I <sub>C</sub> =1.2A ; V <sub>CE</sub> =5V	15		50	
h <sub>FE-2</sub>	DC current gain	I <sub>C</sub> =6A ; V <sub>CE</sub> =5V	8			
f <sub>T</sub>	Transition frequency	I <sub>C</sub> =1.2A ; V <sub>CE</sub> =10V		20		MHz
C <sub>OB</sub>	Output capacitance	I <sub>E</sub> =0 ; V <sub>CB</sub> =10V ; f=1MHz		120		pF

## Switching times

t <sub>on</sub>	Turn-on time	I <sub>C</sub> =7A ; I <sub>B1</sub> =-I <sub>B2</sub> =1.4A R <sub>L</sub> =28.6Ω, P <sub>W</sub> =20μs V <sub>CC</sub> =200V			1.0	μs
t <sub>stg</sub>	Storage time				2.5	μs
t <sub>f</sub>	Fall time				1.0	μs

◆ h<sub>FE-1</sub> Classifications

L	M	N
15-30	20-40	30-50

Silicon NPN Power Transistors

2SC3277

PACKAGE OUTLINE

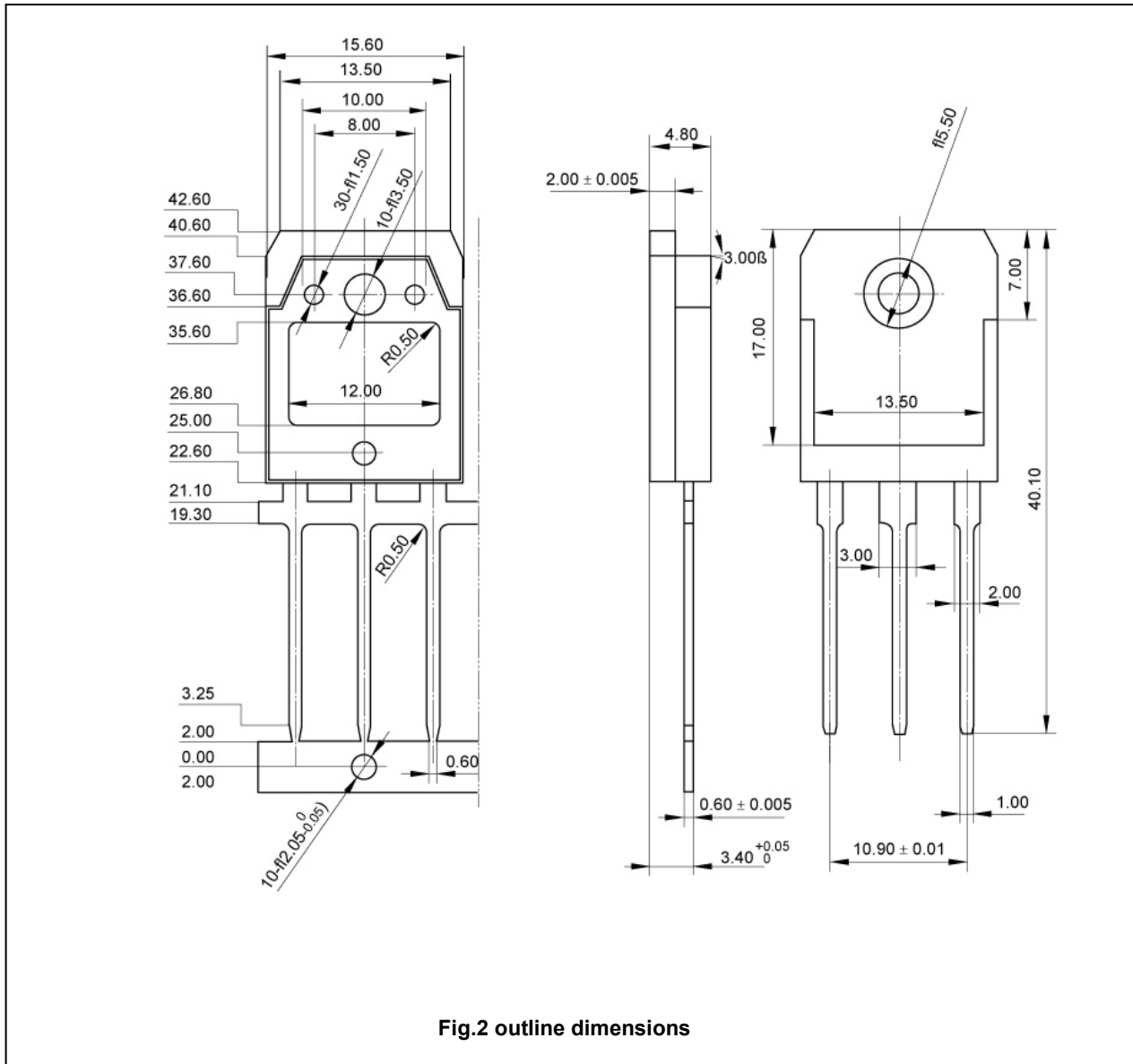

Fig.2 outline dimensions

Silicon NPN Power Transistors

2SC3277

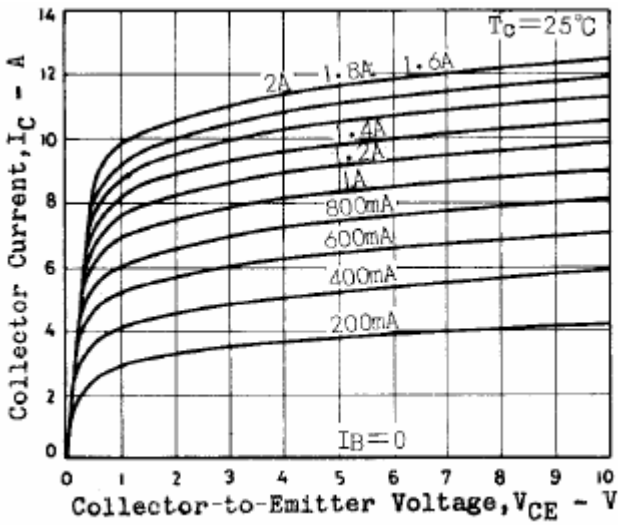

Fig.3 Static Characteristic

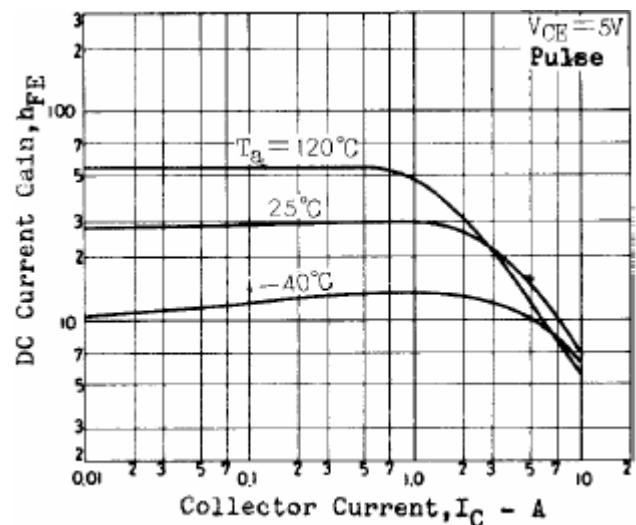

Fig.4 DC current Gain

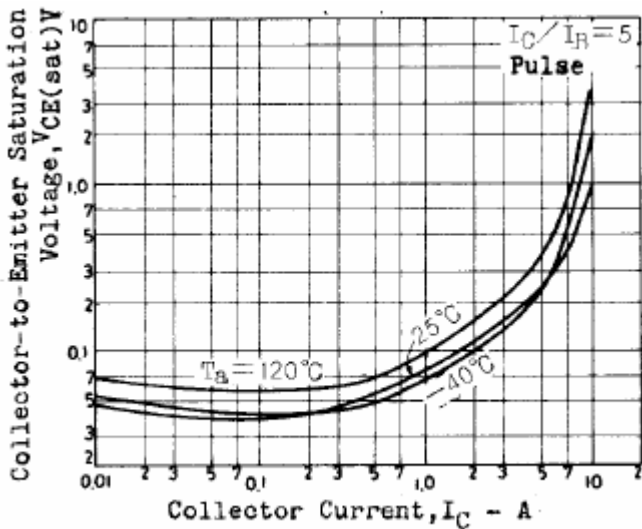

Fig.5 Collector-Emitter Saturation Voltage

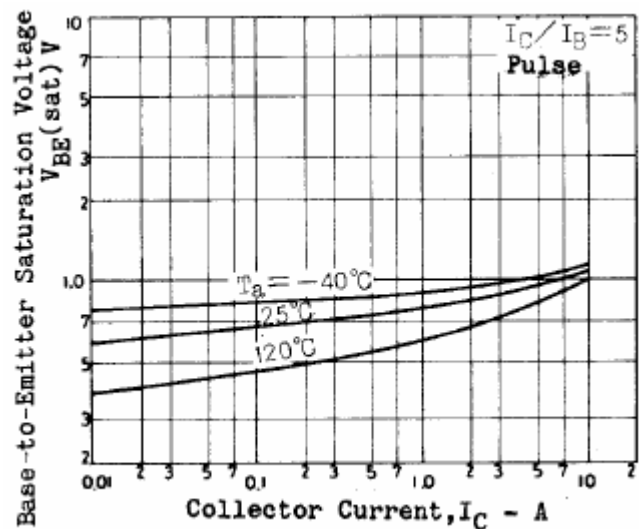

Fig.6 Base-Emitter Saturation Voltage

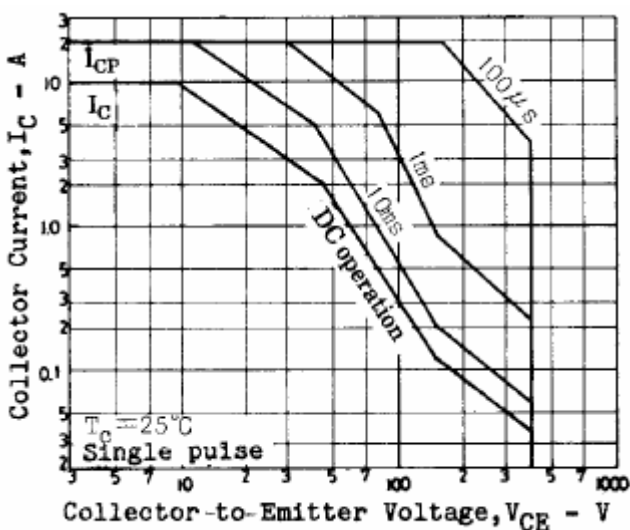

Fig.7 Safe Operating Area