

DS90LT012AH high temperature 3-V LVDS differential line receiver

1 Features

- -40°C to $+125^{\circ}\text{C}$ Temperature Range Operation
- Compatible With ANSI TIA/EIA-644-A Standard
- $>400\text{-Mbps}$ (200-MHz) Switching Rates
- 100-ps Differential Skew (Typical)
- 3.5-ns Maximum Propagation Delay
- Integrated Line Termination Resistor (100 Ω Typical)
- Single 3.3-V Power Supply Design (2.7-V to 3.6-V Range)
- Power-Down High Impedance on LVDS Inputs
- LVDS Inputs Accept LVDS/CML/LVPECL Signals
- Pinout Simplifies PCB Layout
- Low Power Dissipation (10 mW Typical at 3.3-V Static)
- 5-Pin SOT-23 Package

2 Applications

- Board-to-Board Communication
- Test and Measurement
- LED Video Walls
- Motor Drives
- Wireless Infrastructure
- Telecom Infrastructure
- Multi-Function Printers
- NIC Cards
- Rack Servers
- Ultrasound Scanners

3 Description

The DS90LT012AH is a single CMOS differential line receiver designed for applications requiring ultra-low power dissipation, low noise, and high data rates. The devices are designed to support data rates in excess of 400 Mbps (200 MHz) using Low Voltage Differential Swing (LVDS) technology.

The DS90LT012AH accepts low voltage (350 mV typical) differential input signals and translates them to 3-V CMOS output levels. The DS90LT012AH includes an input line termination resistor for point-to-point applications.

The DS90LT012AH and companion LVDS line driver DS90LV011AH provide a new alternative to high power PECL/ECL devices for high-speed interface applications.

Device Information⁽¹⁾

PART NUMBER	PACKAGE	BODY SIZE (NOM)
DS90LT012AH	SOT-23 (5)	2.90 mm x 1.60 mm

(1) For all available packages, see the orderable addendum at the end of the data sheet.

Connection Diagram

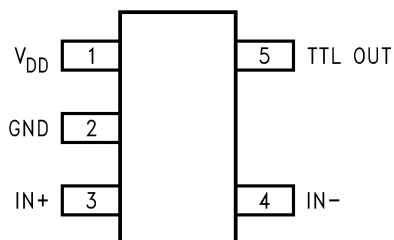

Functional Diagram

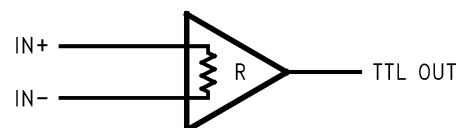

Table of Contents

1 Features	1	8.3 Feature Description	8
2 Applications	1	8.4 Device Functional Modes	10
3 Description	1	9 Application and Implementation	10
4 Revision History	2	9.1 Application Information	10
5 Pin Configuration and Functions	3	9.2 Typical Application	10
6 Specifications	4	10 Power Supply Recommendations	14
6.1 Absolute Maximum Ratings	4	10.1 Power Supply Considerations	14
6.2 ESD Ratings	4	11 Layout	14
6.3 Recommended Operating Conditions	4	11.1 Layout Guidelines	14
6.4 Thermal Information	4	11.2 Layout Example	18
6.5 Electrical Characteristics	4	12 Device and Documentation Support	19
6.6 Switching Characteristics	5	12.1 Receiving Notification of Documentation Updates	19
6.7 Typical Characteristics	6	12.2 Community Resources	19
7 Parameter Measurement Information	7	12.3 Trademarks	19
8 Detailed Description	8	12.4 Electrostatic Discharge Caution	19
8.1 Overview	8	12.5 Glossary	19
8.2 Functional Block Diagram	8	13 Mechanical, Packaging, and Orderable Information	19

4 Revision History

NOTE: Page numbers for previous revisions may differ from page numbers in the current version.

Changes from Revision A (April 2013) to Revision B	Page
• Removed NRND disclaimer from the data sheet	1
• Changed data sheet text and format to TI's latest documentation standards	1
• Moved the ESD Ratings to the <i>ESD Ratings</i> table	4
• Changed and moved thermal resistance (θ_{JA}) parameter in the <i>Absolute Maximum Ratings</i> table to the <i>Thermal Information</i> table	4
• Removed the duplicate <i>Truth Table</i> that shared the same information found in the <i>DS90LT012AH Receiver Function</i> table	8

Changes from Original (April 2013) to Revision A	Page
• Changed layout of National Data Sheet to TI format	1

5 Pin Configuration and Functions

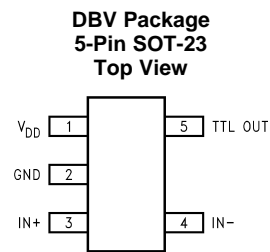

Pin Functions

PIN		I/O	DESCRIPTION
NAME	NO.		
VDD	1	I	Power supply pin, +3.3 V \pm 0.3 V
GND	2	I	Ground pin
IN+	3	I	Non-inverting receiver input pin
IN-	4	I	Inverting receiver input pin
TTL OUT	5	O	LVTTL/LVCMOS receiver output pin

6 Specifications

6.1 Absolute Maximum Ratings ⁽¹⁾

		MIN	MAX	UNIT
Supply Voltage (V_{DD})		-0.3	4	V
Input Voltage (IN+, IN-)		-0.3	3.9	V
Output Voltage (TTL OUT)		-0.3	$V_{DD} + 0.3$	V
Output Short Circuit Current			-100	mA
Maximum Package Power Dissipation at +25°C	DBV Package		902	mW
	Derate DBV Package (above +25°C)		7.22	mW/°C
Lead Temperature Range Soldering	(4 sec.)		260	°C
Maximum Junction Temperature			150	°C
Storage Temperature, T_{stg}		-65	150	°C

- (1) Stresses beyond those listed under *Absolute Maximum Ratings* may cause permanent damage to the device. These are stress ratings only, which do not imply functional operation of the device at these or any other conditions beyond those indicated under *Recommended Operating Conditions*. Exposure to absolute-maximum-rated conditions for extended periods may affect device reliability.

6.2 ESD Ratings

		VALUE	UNIT
$V_{(ESD)}$ Electrostatic discharge	Human-body model (HBM), per ANSI/ESDA/JEDEC JS-001 ⁽¹⁾ (1.5 k Ω , 100 pF)	2000	V
	Charged-device model (CDM), per JEDEC specification JESD22-C101 ⁽²⁾	2000	
	EIAJ (0 Ω , 200 pF)	700	
	IEC direct (330 Ω , 150 pF)	7000	

- (1) JEDEC document JEP155 states that 500-V HBM allows safe manufacturing with a standard ESD control process. Pins listed as $\pm XXX$ V may actually have higher performance.
 (2) JEDEC document JEP157 states that 250-V CDM allows safe manufacturing with a standard ESD control process. Pins listed as ± 2000 V may actually have higher performance.

6.3 Recommended Operating Conditions

	MIN	TYP	MAX	UNIT
Supply Voltage (V_{DD})	+2.7	+3.3	+3.6	V
Ambient Temperature (T_A)	-40	25	+125	°C
Junction Temperature (T_J)			+130	°C

6.4 Thermal Information

THERMAL METRIC ⁽¹⁾		DS90LT012AH	UNIT
		DBV (SOT-23)	
		5 PINS	
$R_{\theta JA}$	Junction-to-ambient thermal resistance	179	°C/W
$R_{\theta JC(top)}$	Junction-to-case (top) thermal resistance	105.5	°C/W
$R_{\theta JB}$	Junction-to-board thermal resistance	44.7	°C/W
Ψ_{JT}	Junction-to-top characterization parameter	20.4	°C/W
Ψ_{JB}	Junction-to-board characterization parameter	44.4	°C/W

- (1) For more information about traditional and new thermal metrics, see the [Semiconductor and IC Package Thermal Metrics](#) application report.

6.5 Electrical Characteristics

Over Supply Voltage and Operating Temperature ranges, unless otherwise specified. ⁽¹⁾ ⁽²⁾

- (1) Current into device pins is defined as positive. Current out of device pins is defined as negative. All voltages are referenced to ground unless otherwise specified (such as V_{ID}).
 (2) All typicals are given for: $V_{DD} = +3.3$ V and $T_A = +25^\circ\text{C}$.

Electrical Characteristics (continued)

Over Supply Voltage and Operating Temperature ranges, unless otherwise specified. ^{(1) (2)}

PARAMETER		TEST CONDITIONS		PIN	MIN	TYP	MAX	UNIT	
V _{TH}	Differential Input High Threshold	V _{CM} dependant on V _{DD} ⁽³⁾		IN+, IN-		-30	0	mV	
V _{TL}	Differential Input Low Threshold					-100	-30		mV
V _{CM}	Common-Mode Voltage	V _{DD} = 2.7 V, V _{ID} = 100 mV				0.05		2.35	V
		V _{DD} = 3 V to 3.6 V, V _{ID} = 100 mV				0.05		V _{DD} - 0.3	V
		T _A = 125°C				0.1		2.35	V
I _{IN}	Input Current (DS90LV012A)	V _{IN} = +2.8 V	V _{DD} = 3.6 V or 0 V			-10	±1	+10	µA
		V _{IN} = 0 V				-10	±1	+10	µA
		V _{IN} = +3.6 V	V _{DD} = 0 V			-20		+20	µA
ΔI _{IN}	Change in Magnitude of I _{IN}	V _{IN} = +2.8 V	V _{DD} = 3.6 V or 0 V				4		µA
		V _{IN} = 0 V					4		µA
		V _{IN} = +3.6 V	V _{DD} = 0 V			4		µA	
I _{IND}	Differential Input Current	V _{IN+} = +0.4 V, V _{IN-} = +0 V			3	3.9	4.4	mA	
		V _{IN+} = +2.4 V, V _{IN-} = +2.0 V							
R _T	Integrated Termination Resistor					100		Ω	
C _{IN}	Input Capacitance	IN+ = IN- = GND				3		pF	
V _{OH}	Output High Voltage	I _{OH} = -0.4 mA, V _{ID} = +200 mV		TTL OUT	2.4	3.1		V	
		I _{OH} = -0.4 mA, Inputs terminated			2.4	3.1		V	
		I _{OH} = -0.4 mA, Inputs shorted			2.4	3.1		V	
I _{OL} = 2 mA, V _{ID} = -200 mV			0.3		0.5	V			
V _{OL}	Output Low Voltage								
I _{OS}	Output Short-Circuit Current	V _{OUT} = 0V ⁽⁴⁾				-15	-50	-100	mA
V _{CL}	Input Clamp Voltage	I _{CL} = -18 mA			-1.5	-0.7		V	
I _{DD}	No Load Supply Current	Inputs Open		V _{DD}		5.4	9	mA	

(3) V_{DD} is always higher than IN+ and IN- voltage. IN+ and IN- are allowed to have voltage range -0.05 V to +2.35 V when V_{DD} = 2.7 V and |V_{ID}| / 2 to V_{DD} - 0.3 V when V_{DD} = 3.0 V to 3.6 V. V_{ID} is not allowed to be greater than 100 mV when V_{CM} = 0.05 V to 2.35 V when V_{DD} = 2.7 V or when V_{CM} = |V_{ID}| / 2 to V_{DD} - 0.3 V when V_{DD} = 3.0 V to 3.6 V.

(4) Output short-circuit current (I_{OS}) is specified as magnitude only, minus sign indicates direction only. Only one output should be shorted at a time, do not exceed maximum junction temperature specification.

6.6 Switching Characteristics

Over Supply Voltage and Operating Temperature ranges, unless otherwise specified. ^{(1) (2)}

PARAMETER		MIN	TYP	MAX	UNIT
t _{PHLD}	Differential Propagation Delay High to Low	1	1.8	3.5	ns
t _{PLHD}	Differential Propagation Delay Low to High	1	1.7	3.5	ns
t _{SKD1}	Differential Pulse Skew t _{PHLD} - t _{PLHD} ⁽³⁾	0	100	400	ps
t _{SKD3}	Differential Part to Part Skew ⁽⁴⁾	0	0.3	1.0	ns
t _{SKD4}	Differential Part to Part Skew ⁽⁵⁾	0	0.4	1.5	ns
t _{TLH}	Rise Time		350	800	ps
t _{THL}	Fall Time		175	800	ps
f _{MAX}	Maximum Operating Frequency ⁽⁶⁾	200	250		MHz

(1) C_L includes probe and jig capacitance.

(2) Generator waveform for all tests unless otherwise specified: f = 1 MHz, Z_O = 50 Ω, t_r and t_f (0% to 100%) ≤ 3 ns for IN±.

(3) t_{SKD1} is the magnitude difference in differential propagation delay time between the positive-going-edge and the negative-going-edge of the same channel.

(4) t_{SKD3}, part to part skew, is the differential channel-to-channel skew of any event between devices. This specification applies to devices at the same V_{DD} and within 5°C of each other within the operating temperature range.

(5) t_{SKD4}, part to part skew, is the differential channel-to-channel skew of any event between devices. This specification applies to devices over the recommended operating temperature and voltage ranges, and across process distribution. t_{SKD4} is defined as |Max - Min| differential propagation delay.

(6) f_{MAX} generator input conditions: t_r = t_f < 1 ns (0% to 100%), 50% duty cycle, differential (1.05 V to 1.35 peak to peak). Output criteria: 60%/40% duty cycle, V_{OL} (max 0.4 V), V_{OH} (min 2.4 V), load = 15 pF (stray plus probes). The parameter is specified by design. The limit is based on the statistical analysis of the device over the PVT range by the transition times (t_{TLH} and t_{THL}).

6.7 Typical Characteristics

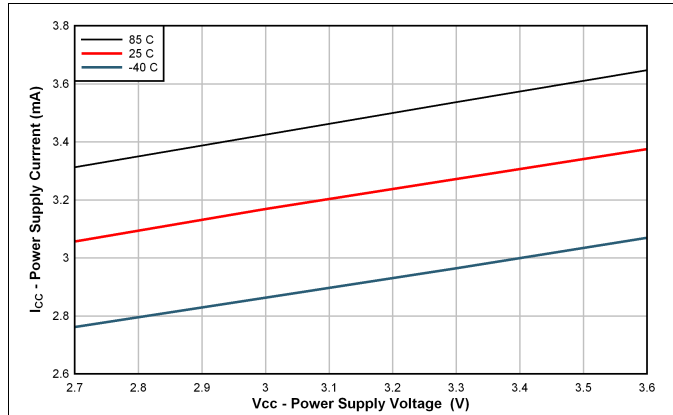

Figure 1. Power Supply Current vs Power Supply Voltage

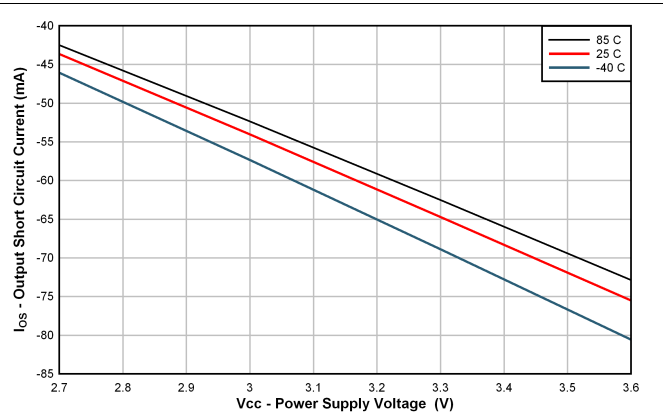

Figure 2. Output Short-Circuit Current vs Power Supply Voltage

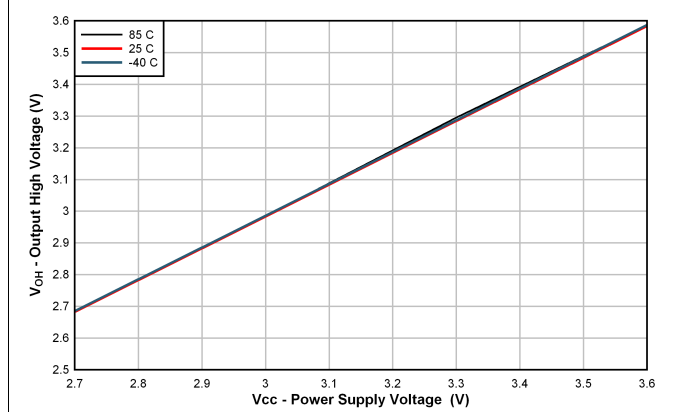

Figure 3. Output High Voltage vs Power Supply Voltage

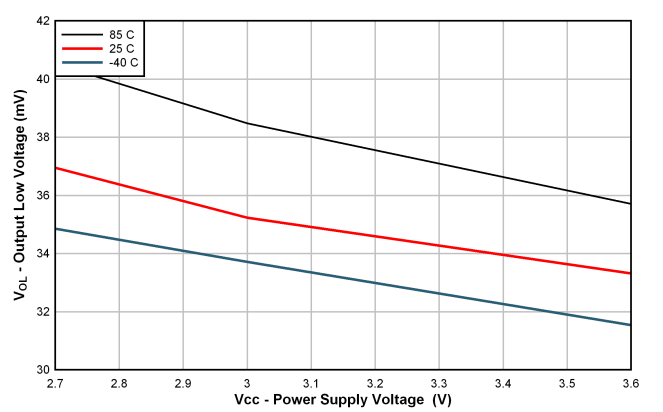

Figure 4. Output Low Voltage vs Power Supply Voltage

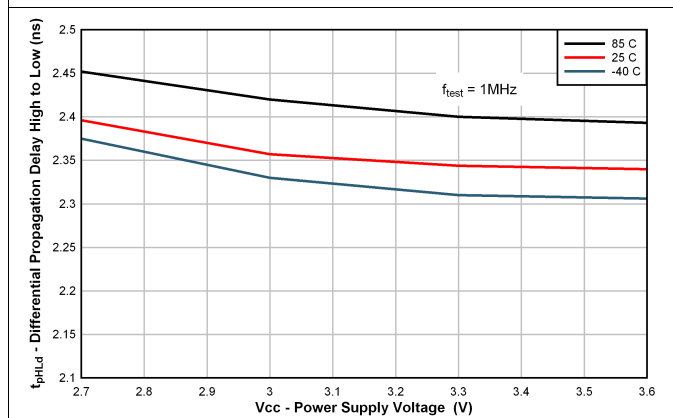

Figure 5. Differential Propagation Delay High to Low vs Power Supply Voltage at 1 MHz

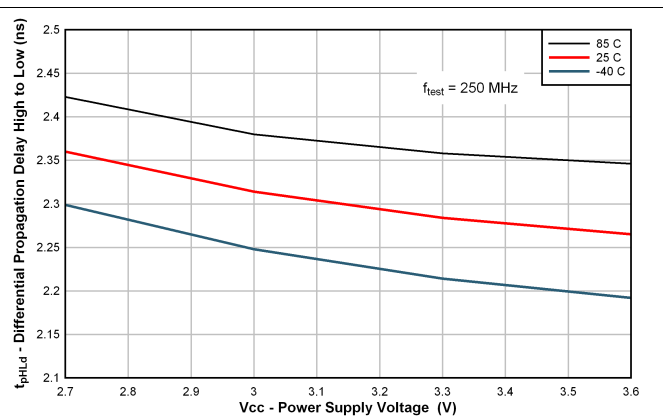
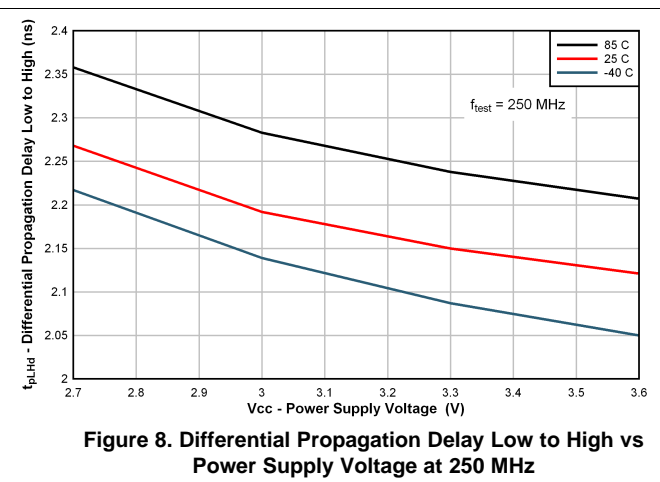
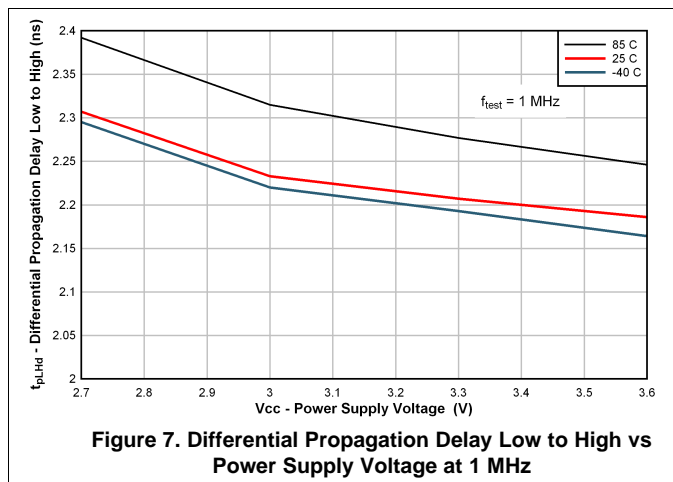

Figure 6. Differential Propagation Delay High to Low vs Power Supply Voltage at 250 MHz

Typical Characteristics (continued)



7 Parameter Measurement Information

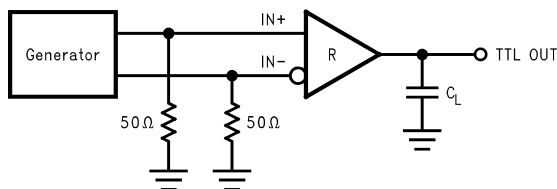

Figure 9. Receiver Propagation Delay and Transition Time Test Circuit

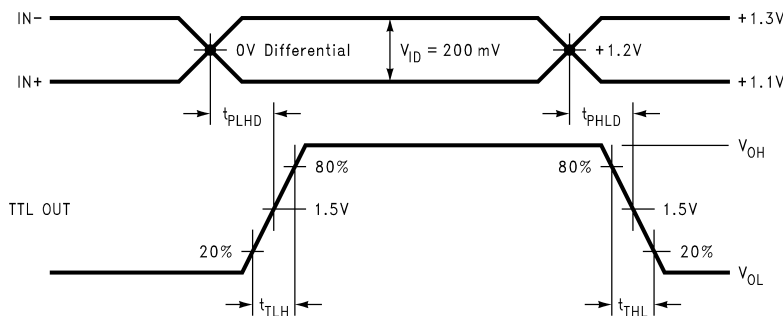

Figure 10. Receiver Propagation Delay and Transition Time Waveforms

8 Detailed Description

8.1 Overview

The DS90LT012AH is a single-channel, low-voltage differential signaling (LVDS) line receiver. It operates from a single power supply that is nominally 3.3 V, but the supply can be as low as 3 V and as high as 3.6 V. The input to the DS90LT012AH is a differential signal complying with the LVDS Standard (TIA/EIA-644), and the output is a 3.3-V LVCMOS/LVTTL signal. The differential input signal operates with a signal level of 340 mV, nominally, at a common-mode voltage of 1.2 V. The differential nature of the inputs provides immunity to common-mode coupled signals that the driven signal may experience. A termination resistor of 100 Ω is intergrated into DS90LT012AH.

LVDS receivers are intended to be primarily used in an point-to-point configuration. This configuration provides a clean signaling environment for the fast edge rates of the drivers. The receiver is connected to the driver through a balanced media which may be a standard twisted-pair cable, a parallel pair cable, or simply PCB traces. Typically the characteristic impedance of the media is in the range of 100 Ω . The intergrated termination resistor converts the driver output (current mode) into a voltage without the need for external termination and is detected by the receiver. Other configurations are possible such as a multi-receiver configuration, but the effects of a mid-stream connector(s), cable stub(s), and other impedance discontinuities as well as ground shifting, noise margin limits, and total termination loading must be taken into account.

8.2 Functional Block Diagram

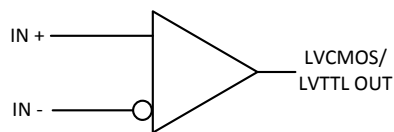

8.3 Feature Description

The DS90LT012AH is capable of detecting signals as low as 100 mV, over a ± 1 -V common-mode range centered around 1.2 V. The AC parameters of the input pins are optimized for a recommended operating input voltage range of 0 V to 2.4 V (measured from each pin to ground). The device will operate for receiver input voltages up to V_{DD} , but exceeding V_{DD} will turn on the ESD protection circuitry which will clamp the bus voltages.

Table 1. DS90LT012AH Receiver Function

INPUTS	OUTPUT
$V_{ID} = [IN+] - [IN-]$	TTL OUT
$V_{ID} \geq 0$ V	H
$V_{ID} \leq -0.1$ V	L
Full Fail-safe OPEN/SHORT or Terminated	H

8.3.1 Termination

DS90LT012AH integrates the terminating resistor for point-to-point applications. The resistor value will be between 90 Ω and 133 Ω .

8.3.2 Threshold

The LVDS Standard (ANSI/TIA/EIA-644-A) specifies a maximum threshold of ± 100 mV for the LVDS receiver. The DS90LT012AH supports an enhanced threshold region of -100 mV to 0 V. This is useful for fail-safe biasing. The threshold region is shown in the Voltage Transfer Curve (VTC) in [Figure 11](#). The typical DS90LT012AH LVDS receiver switches at about -30 mV. Note that with $V_{ID} = 0$ V, the output will be in a HIGH state. With an external fail-safe bias of $+25$ mV applied, the typical differential noise margin is now the difference from the switch point to the bias point. In the example shown in [Figure 11](#), this would be 55 mV of Differential Noise

Margin (DNM) (+25 mV – (-30 mV)). With the enhanced threshold region of -100 mV to 0 V, this small external fail-safe biasing of +25 mV (with respect to 0 V) gives a DNM of a comfortable 55 mV. With the standard threshold region of ± 100 mV, the external fail-safe biasing must be +25 mV with respect to +100 mV or +125 mV, giving a DNM of 155 mV that is a stronger fail-safe biasing than necessary for the DS90LT012AH. If more DNM is required, then a stronger fail-safe bias point can be set by changing resistor values.

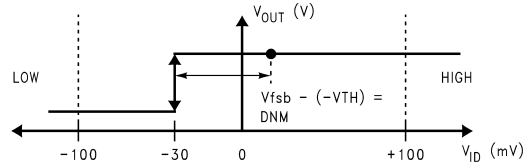

Figure 11. VTC of the DS90LT012AH LVDS Receiver

8.3.3 Fail-Safe Feature

The LVDS receiver is a high-gain, high-speed device that amplifies a small differential signal (20 mV) to LVCMOS/LVTTL logic levels. Due to the high gain and tight threshold of the receiver, take care to prevent noise from appearing as a valid signal.

The receiver's internal fail-safe circuitry is designed to source/sink a small amount of current, providing fail-safe protection (a stable known state of HIGH output voltage) for floating, terminated, or shorted receiver inputs.

1. **Open Input Pins:** It is not required to tie the receiver inputs to ground or any supply voltage. Internal failsafe circuitry will ensure a HIGH, stable output state for open inputs.
2. **Terminated Input:** If the driver is disconnected (cable unplugged), or if the driver is in a power-off condition, the receiver output will again be in a HIGH state, even with the end cable 100- Ω termination resistor across the input pins. The unplugged cable can become a floating antenna which can pick up noise. If the cable picks up more than 10 mV of differential noise, the receiver may see the noise as a valid signal and switch. To insure that any noise is seen as common-mode and not differential, a balanced interconnect should be used. A twisted-pair cable will offer better balance than flat ribbon cable.
3. **Shorted Inputs:** If a fault condition occurs that shorts the receiver inputs together, thus resulting in a 0-V differential input voltage, the receiver output will remain in a HIGH state. Shorted input fail-safe is not supported across the common-mode range of the device (GND to 2.4 V). It is only supported with inputs shorted and no external common-mode voltage applied.

External lower value pullup and pulldown resistors (for a stronger bias) may be used to boost fail-safe in the presence of higher noise levels. The pullup and pulldown resistors should be in the 5-k Ω to 15-k Ω range to minimize loading and waveform distortion to the driver. The common-mode bias point should be set to approximately 1.2 V (less than 1.75 V) to be compatible with the internal circuitry.

The DS90LT012AH is compliant to the original ANSI EIA/TIA-644 specification and is also compliant to the new ANSI EIA/TIA-644-A specification with the exception of the newly added ΔI_{IN} specification. Due to the internal fail-safe circuitry, ΔI_{IN} cannot meet the 6- μ A maximum specified. This exception will not be relevant unless more than 10 receivers are used.

Additional information on the fail-safe biasing of LVDS devices may be found in [AN-1194 Failsafe Biasing of LVDS Interfaces](#) (SNLA051).

8.3.4 Probing LVDS Transmission Lines

Always use high impedance (> 100 k Ω), low capacitance (< 2 pF) scope probes with a wide bandwidth (1 GHz) scope. Improper probing will give deceiving results.

8.3.5 Cables and Connectors, General Comments

When choosing cable and connectors for LVDS, it is important to remember:

- Use controlled impedance media. The cables and connectors used should have a matched differential impedance of about 100 Ω . They should not introduce major impedance discontinuities.
- Balanced cables (that is, twisted-pair) are usually better than unbalanced cables (ribbon cable, simple coax) for noise reduction and signal quality. Balanced cables tend to generate less EMI due to field canceling effects and also tend to pick up electromagnetic radiation and common-mode (not differential mode) noise rejected by the receiver.
- For cable distances < 0.5 M, most cables can be made to work effectively. For distances $0.5 \text{ M} \leq d \leq 10 \text{ M}$, CAT 3 (category 3) twisted-pair cable works well, and this cable is readily available and relatively inexpensive.

8.4 Device Functional Modes

The device has one mode of operation that applies when operated within the [Recommended Operating Conditions](#).

9 Application and Implementation

NOTE

Information in the following applications sections is not part of the TI component specification, and TI does not warrant its accuracy or completeness. TI's customers are responsible for determining suitability of components for their purposes. Customers should validate and test their design implementation to confirm system functionality.

9.1 Application Information

The DS90LT012AH device is a single-channel LVDS receiver. The functionality of this device is simple, yet extremely flexible, leading to its use in designs ranging from wireless base stations to desktop computers. The varied class of potential applications share features and applications are discussed in the [Typical Application](#) section.

9.2 Typical Application

9.2.1 Point-to-Point Communications

The most basic application for LVDS buffers, as found in this data sheet, is for point-to-point communications of digital data shown in [Figure 12](#).

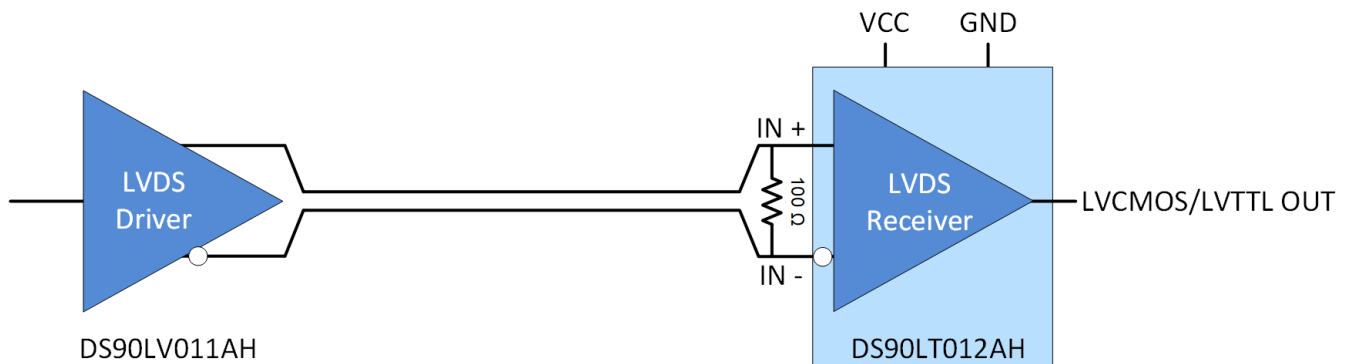

Figure 12. Typical Application

Typical Application (continued)

A point-to-point communications channel has a single transmitter (driver) and a single receiver. This communications topology is often referred to as simplex. In [Figure 12](#), the driver receives a single-ended input signal and the receiver outputs a single-ended recovered signal. The LVDS driver converts the single-ended input to a differential signal for transmission over a balanced interconnecting media of 100-Ω characteristic impedance. The conversion from a single-ended signal to an LVDS signal retains the digital data payload while translating to a signal whose features are more appropriate for communication over extended distances or in a noisy environment.

9.2.1.1 Design Requirements

[Table 2](#) lists the design parameters for this example.

Table 2. Design Parameters

DESIGN PARAMETERS	EXAMPLE VALUE
Receiver Supply Voltage (V_{CC})	3 to 3.6 V
Receiver Output Voltage	0 to 3.6 V
Signaling Rate	0 to 400 Mbps
Interconnect Characteristic Impedance	100 Ω
Termination Resistance	100 Ω
Number of Receiver Nodes	1
Ground shift between driver and receiver	±1 V

9.2.1.2 Detailed Design Procedure

9.2.1.2.1 Receiver Bypass Capacitance

Bypass capacitors play a key role in power distribution circuitry. Specifically, they create low-impedance paths between power and ground. At low frequencies, a good digital power supply offers very low-impedance paths between its terminals. However, as higher frequency currents propagate through power traces, the source is quite often incapable of maintaining a low-impedance path to ground. Bypass capacitors are used to address this shortcoming. Usually, large bypass capacitors (10 μF to 1000 μF) at the board-level do a good job up into the kHz range. Due to their size and length of their leads, they tend to have large inductance values at the switching frequencies of modern digital circuitry. To solve this problem, one must resort to the use of smaller capacitors (nF to μF range) installed locally next to the integrated circuit.

Multilayer ceramic chip or surface-mount capacitors (size 0603 or 0805) minimize lead inductances of bypass capacitors in high-speed environments, because their lead inductance is about 1 nH. For comparison purposes, a typical capacitor with leads has a lead inductance around 5 nH.

The value of the bypass capacitors used locally with LVDS chips can be determined by [Equation 1](#) and [Equation 2](#) according to Johnson⁽¹⁾ equations 8.18 to 8.21. A conservative rise time of 200 ps and a worst-case change in supply current of 1 A covers the whole range of LVDS devices offered by Texas Instruments. In this example, the maximum power supply noise tolerated is 200 mV. However, this figure varies depending on the noise budget available in the design. ⁽¹⁾

$$C_{\text{chip}} = \left(\frac{\Delta I_{\text{Maximum Step Change Supply Current}}}{\Delta V_{\text{Maximum Power Supply Noise}}} \right) \times T_{\text{Rise Time}} \quad (1)$$

$$C_{\text{LVDS}} = \left(\frac{1\text{A}}{0.2\text{V}} \right) \times 200 \text{ ps} = 0.001 \mu\text{F} \quad (2)$$

[Figure 13](#) lowers lead inductance and covers intermediate frequencies between the board-level capacitor (>10 μF) and the value of capacitance found above (0.001 μF). TI recommends that the user place the smallest value of capacitance as close to the chip as possible.

(1) Howard Johnson & Martin Graham. 1993. High Speed Digital Design – A Handbook of Black Magic. Prentice Hall PRT. ISBN number 013395724.

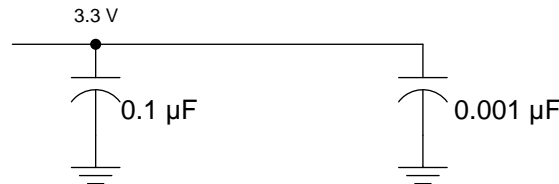

Figure 13. Recommended LVDS Bypass Capacitor Layout

9.2.1.2.2 Interconnecting Media

The physical communication channel between the driver and the receiver may be any balanced and paired metal conductors meeting the requirements of the LVDS standard, the key points of which are included here. This media may be a twisted-pair, twinax, flat ribbon cable, or PCB traces.

The nominal characteristic impedance of the interconnect should be between 100 Ω and 120 Ω with a variation of no more than 10% (90 Ω to 132 Ω).

9.2.1.2.3 PCB Transmission Lines

As per the *LVDS Owner's Manual Design Guide, 4th Edition* (SNLA187), Figure 14 depicts several transmission line structures commonly used in printed-circuit boards (PCBs). Each structure consists of a signal line and return path with a uniform cross section along its length. A microstrip is a signal trace on the top (or bottom) layer, separated by a dielectric layer from its return path in a ground or power plane. A stripline is a signal trace in the inner layer, with a dielectric layer in between a ground plane above and below the signal trace. The dimensions of the structure along with the dielectric material properties determine the characteristic impedance of the transmission line (also called controlled-impedance transmission line).

When two signal lines are placed close by, they form a pair of coupled transmission lines. Figure 14 shows examples of edge-coupled microstrip lines, and edge-coupled or broad-side-coupled striplines. When excited by differential signals, the coupled transmission line is referred to as a differential pair. The characteristic impedance of each line is called odd-mode impedance. The sum of the odd-mode impedances of each line is the differential impedance of the differential pair. In addition to the trace dimensions and dielectric material properties, the spacing between the two traces determines the mutual coupling and impacts the differential impedance. When the two lines are immediately adjacent; for example, S is less than 2W, the differential pair is called a tightly-coupled differential pair. To maintain constant differential impedance along the length, it is important to keep the trace width and spacing uniform along the length, as well as maintain good symmetry between the two lines.

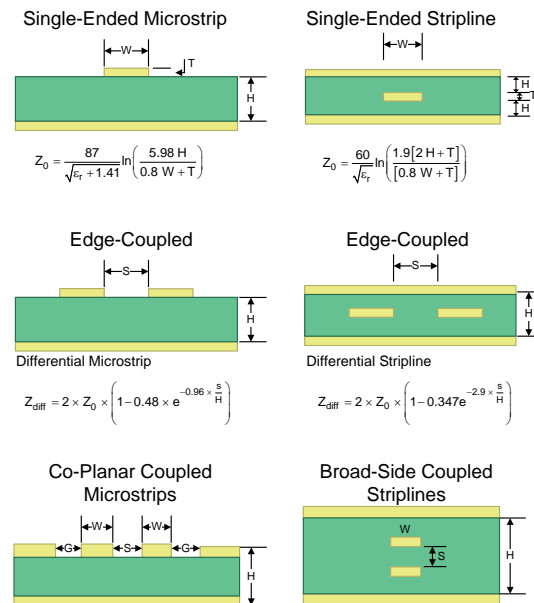

Figure 14. Controlled-Impedance Transmission Lines

9.2.1.3 Application Curve

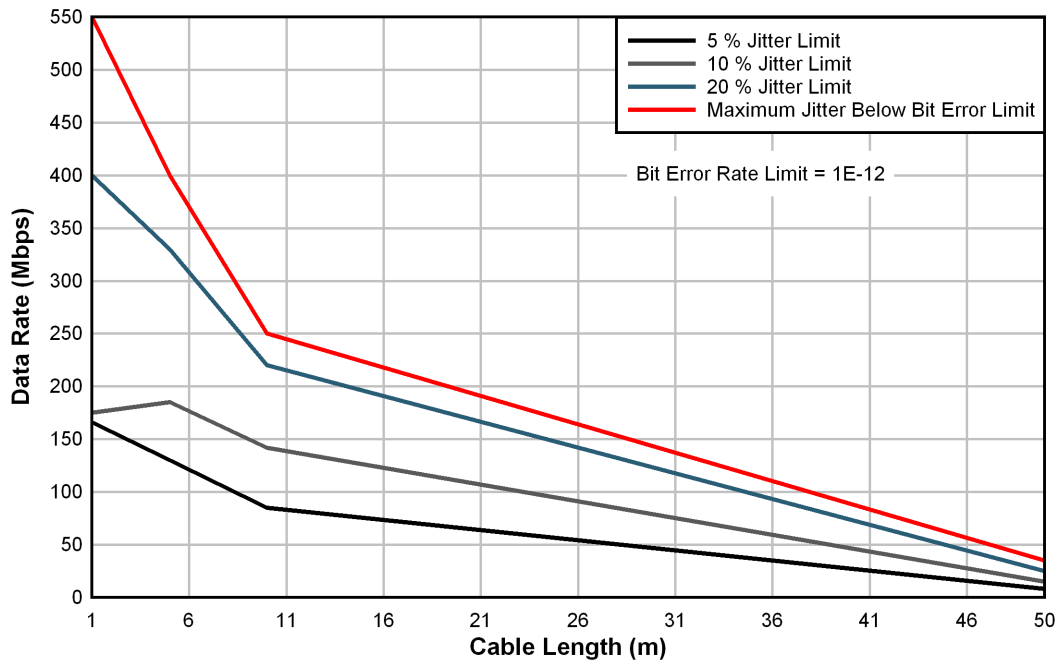

Figure 15. DS90LT012AH Performance: Cable Length vs Data Rate

10 Power Supply Recommendations

10.1 Power Supply Considerations

The DS90LT012AH driver is designed to operate from a single power supply with the supply voltage range of 3 V to 3.6 V. In a typical application, a driver and a receiver may be on separate boards, or even separate equipment. In these cases, separate supplies would be used at each location. The expected ground potential difference between the driver power supply and the receiver power supply would be less than $|\pm 1\text{ V}|$. Board level and local device level bypass capacitance should be used.

11 Layout

11.1 Layout Guidelines

11.1.1 Microstrip vs. Stripline Topologies

As per the *LVDS Application and Data Handbook* (SLLD009), printed-circuit boards usually offer designers two transmission line options: Microstrip and stripline. Microstrips are traces on the outer layer of a PCB, as shown in Figure 16.

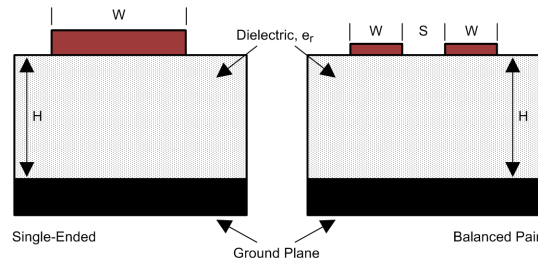

Figure 16. Microstrip Topology

On the other hand, striplines are traces between two ground planes. Striplines are less prone to emissions and susceptibility problems because the reference planes effectively shield the embedded traces. However, from the standpoint of high-speed transmission, juxtaposing two planes creates additional capacitance. TI recommends routing LVDS signals on microstrip transmission lines when possible. The PCB traces allow designers to specify the necessary tolerances for Z_0 based on the overall noise budget and reflection allowances. Footnotes 1⁽²⁾, 2⁽³⁾, and 3⁽⁴⁾ provide formulas for Z_0 and t_{PD} for differential and single-ended traces. ⁽²⁾ ⁽³⁾ ⁽⁴⁾

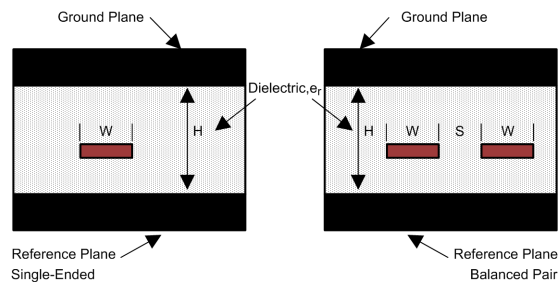

Figure 17. Stripline Topology

(2) Howard Johnson & Martin Graham. 1993. *High Speed Digital Design – A Handbook of Black Magic*. Prentice Hall PRT. ISBN number 013395724.

(3) Mark I. Montrose. 1996. *Printed Circuit Board Design Techniques for EMC Compliance*. IEEE Press. ISBN number 0780311310.

(4) Clyde F. Coombs, Jr. Ed, *Printed Circuits Handbook*, McGraw Hill, ISBN number 0070127549.

Layout Guidelines (continued)

11.1.2 Dielectric Type and Board Construction

The speeds at which signals travel across the board dictates the choice of dielectric. FR-4, or equivalent, usually provides adequate performance for use with LVDS signals. If rise or fall times of LVCMOS/LVTTL signals are less than 500 ps, empirical results indicate that a material with a dielectric constant near 3.4, such as Rogers™ 4350 or Nelco N4000-13 is better suited. Once the designer chooses the dielectric, there are several parameters pertaining to the board construction that can affect performance. The following set of guidelines were developed experimentally through several designs involving LVDS devices:

- Copper weight: 15 g or 1/2 oz start, plated to 30 g or 1 oz
- All exposed circuitry should be solder-plated (60/40) to 7.62 μm or 0.0003 in (minimum).
- Copper plating should be 25.4 μm or 0.001 in (minimum) in plated-through-holes.
- Solder mask over bare copper with solder hot-air leveling

11.1.3 Recommended Stack Layout

Following the choice of dielectrics and design specifications, the designer must decide how many levels to use in the stack. To reduce the LVCMOS/LVTTL to LVDS crosstalk, it is good practice to have at least two separate signal planes as shown in [Figure 18](#).

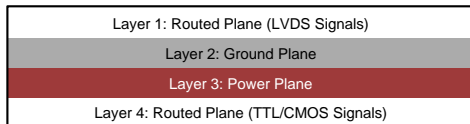

Figure 18. Four-Layer PCB Board

NOTE

The separation between layers 2 and 3 should be 127 μm (0.005 in). By keeping the power and ground planes tightly coupled, the increased capacitance acts as a bypass for transients.

One of the most common stack configurations is the six-layer board, as shown in [Figure 19](#).

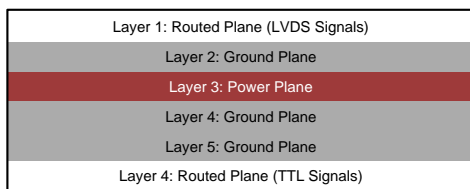

Figure 19. Six-Layer PCB Board

In this particular configuration, it is possible to isolate each signal layer from the power plane by at least one ground plane. The result is improved signal integrity, but fabrication is more expensive. Using the 6-layer board is preferable, because it offers the layout designer more flexibility in varying the distance between signal layers and referenced planes in addition to ensuring reference to a ground plane for signal layers 1 and 6.

11.1.4 Separation Between Traces

The separation between traces depends on several factors, but the amount of coupling that can be tolerated usually dictates the actual separation. Low-noise coupling requires close coupling between the differential pair of an LVDS link to benefit from the electromagnetic field cancellation. The traces should be 100- Ω differential and thus coupled in the manner that best fits this requirement. In addition, differential pairs should have the same electrical length to ensure that they are balanced, thus minimizing problems with skew and signal reflection.

Layout Guidelines (continued)

In the case of two adjacent single-ended traces, one should use the 3-W rule: the distance between two traces must be greater than two times the width of a single trace, or three times its width measured from trace center to trace center. This increased separation effectively reduces the potential for crosstalk. The same rule should be applied to the separation between adjacent LVDS differential pairs, whether the traces are edge-coupled or broad-side-coupled.

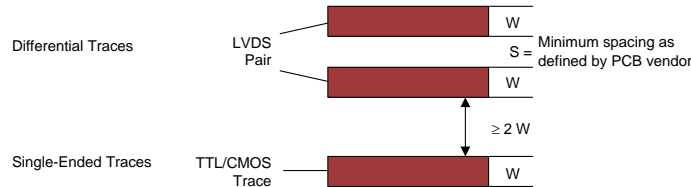

Figure 20. 3-W Rule for Single-Ended and Differential Traces (Top View)

Exercise caution when using autorouters, because they do not always account for all factors affecting crosstalk and signal reflection. For instance, it is best to avoid sharp 90° turns to prevent discontinuities in the signal path. Using successive 45° turns tends to minimize reflections.

11.1.5 Crosstalk and Ground Bounce Minimization

To reduce crosstalk, it is important to provide a return path to high-frequency currents that is as close to its originating trace as possible. A ground plane usually achieves this. Because the returning currents always choose the path of lowest inductance, they are most likely to return directly under the original trace, thus minimizing crosstalk. Lowering the area of the current loop lowers the potential for crosstalk. Traces kept as short as possible with an uninterrupted ground plane running beneath them emit the minimum amount of electromagnetic field strength. Discontinuities in the ground plane increase the return path inductance and should be avoided.

11.1.6 Decoupling

Each power or ground lead of a high-speed device should be connected to the PCB through a low inductance path. For best results, one or more vias are used to connect a power or ground pin to the nearby plane. TI recommends placing a via immediately adjacent to the pin to avoid adding trace inductance. Placing a power plane closer to the top of the board reduces the effective via length and its associated inductance.

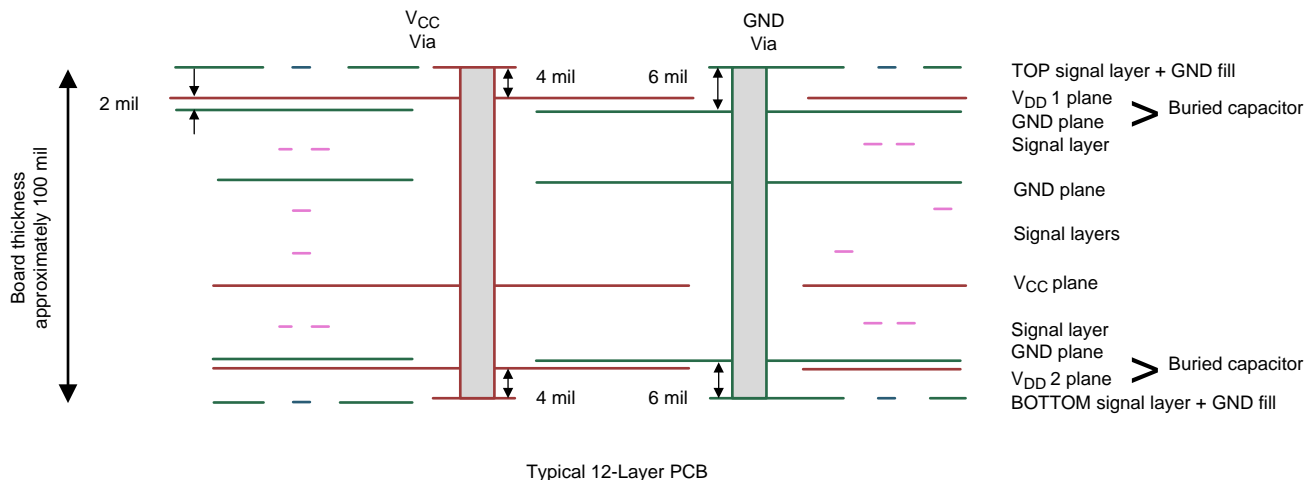

Figure 21. Low Inductance, High-Capacitance Power Connection

Layout Guidelines (continued)

Bypass capacitors should be placed close to V_{DD} pins. They can be placed conveniently near the corners or underneath the package to minimize the loop area. This extends the useful frequency range of the added capacitance. Small-physical-size capacitors, such as 0402 or even 0201, or X7R surface-mount capacitors should be used to minimize body inductance of capacitors. Each bypass capacitor is connected to the power and ground plane through vias tangent to the pads of the capacitor as shown in Figure 22(a).

An X7R surface-mount capacitor of size 0402 has about 0.5 nH of body inductance. At frequencies above 30 MHz or so, X7R capacitors behave as low-impedance inductors. To extend the operating frequency range to a few hundred MHz, an array of different capacitor values like 100 pF, 1 nF, 0.03 μ F, and 0.1 μ F are commonly used in parallel. The most effective bypass capacitor can be built using sandwiched layers of power and ground at a separation of 2 to 3 mils. With a 2-mil FR4 dielectric, there is approximately 500 pF per square inch of PCB. Refer back to Figure 14 for some examples. Many high-speed devices provide a low-inductance GND connection on the backside of the package. This center dap must be connected to a ground plane through an array of vias. The via array reduces the effective inductance to ground and enhances the thermal performance of the small Surface Mount Technology (SMT) package. Placing vias around the perimeter of the dap connection ensures proper heat spreading and the lowest possible die temperature. Placing high-performance devices on opposing sides of the PCB using two GND planes (as shown in Figure 14) creates multiple paths for heat transfer. Often thermal PCB issues are the result of one device adding heat to another, resulting in a very high local temperature. Multiple paths for heat transfer minimize this possibility. In many cases the GND dap that is so important for heat dissipation makes the optimal decoupling layout impossible to achieve due to insufficient pad-to-dap spacing as shown in Figure 22(b). When this occurs, placing the decoupling capacitor on the backside of the board keeps the extra inductance to a minimum. It is important to place the V_{DD} via as close to the device pin as possible while still allowing for sufficient solder mask coverage. If the via is left open, solder may flow from the pad and into the via barrel. This will result in a poor solder connection.



Figure 22. Typical Decoupling Capacitor Layouts

At least two or three times the width of an individual trace should separate single-ended traces and differential pairs to minimize the potential for crosstalk. Single-ended traces that run in parallel for less than the wavelength of the rise or fall times usually have negligible crosstalk. Increase the spacing between signal paths for long parallel runs to reduce crosstalk. Boards with limited real estate can benefit from the staggered trace layout, as shown in Figure 23.

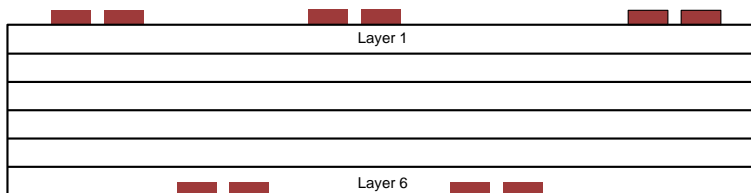

Figure 23. Staggered Trace Layout

This configuration lays out alternating signal traces on different layers. Thus, the horizontal separation between traces can be less than 2 or 3 times the width of individual traces. To ensure continuity in the ground signal path, TI recommends having an adjacent ground via for every signal via, as shown in Figure 24. Note that vias create additional capacitance. For example, a typical via has a lumped capacitance effect of 1/2 pF to 1 pF in FR4.

Layout Guidelines (continued)

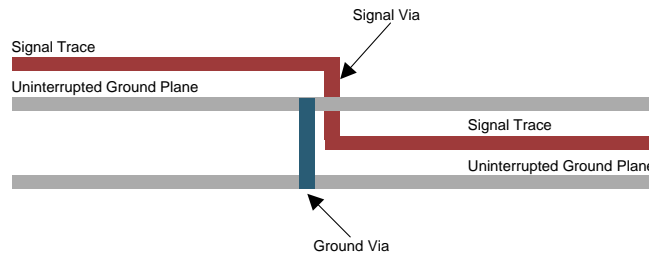

Figure 24. Ground Via Location (Side View)

Short and low-impedance connection of the device ground pins to the PCB ground plane reduces ground bounce. Holes and cutouts in the ground planes can adversely affect current return paths if they create discontinuities that increase returning current loop areas.

To minimize EMI problems, TI recommends avoiding discontinuities below a trace (for example, holes, slits, and so on) and keeping traces as short as possible. Zoning the board wisely by placing all similar functions in the same area, as opposed to mixing them together, helps reduce susceptibility issues.

11.2 Layout Example

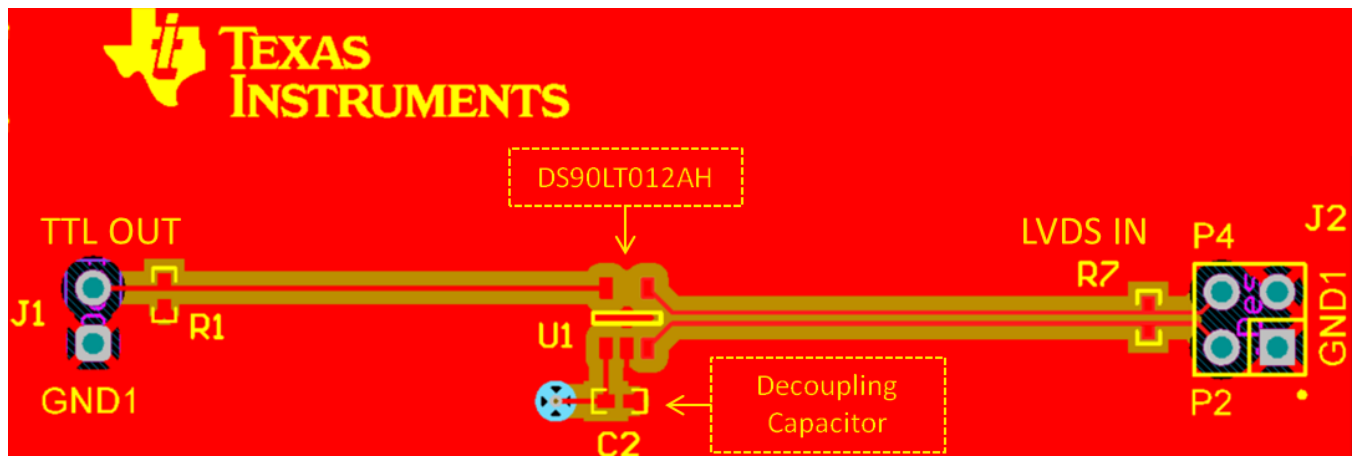

Figure 25. Example DS90LT012AH Layout

12 Device and Documentation Support

12.1 Receiving Notification of Documentation Updates

To receive notification of documentation updates, navigate to the device product folder on ti.com. In the upper right corner, click on *Alert me* to register and receive a weekly digest of any product information that has changed. For change details, review the revision history included in any revised document.

12.2 Community Resources

The following links connect to TI community resources. Linked contents are provided "AS IS" by the respective contributors. They do not constitute TI specifications and do not necessarily reflect TI's views; see TI's [Terms of Use](#).

TI E2E™ Online Community *TI's Engineer-to-Engineer (E2E) Community*. Created to foster collaboration among engineers. At e2e.ti.com, you can ask questions, share knowledge, explore ideas and help solve problems with fellow engineers.

Design Support *TI's Design Support* Quickly find helpful E2E forums along with design support tools and contact information for technical support.

12.3 Trademarks

E2E is a trademark of Texas Instruments.

Rogers is a trademark of Rogers Corporation.

All other trademarks are the property of their respective owners.

12.4 Electrostatic Discharge Caution



This integrated circuit can be damaged by ESD. Texas Instruments recommends that all integrated circuits be handled with appropriate precautions. Failure to observe proper handling and installation procedures can cause damage.

ESD damage can range from subtle performance degradation to complete device failure. Precision integrated circuits may be more susceptible to damage because very small parametric changes could cause the device not to meet its published specifications.

12.5 Glossary

[SLYZ022](#) — *TI Glossary*.

This glossary lists and explains terms, acronyms, and definitions.

13 Mechanical, Packaging, and Orderable Information

The following pages include mechanical, packaging, and orderable information. This information is the most current data available for the designated devices. This data is subject to change without notice and revision of this document. For browser-based versions of this data sheet, refer to the left-hand navigation.

PACKAGING INFORMATION

Orderable Device	Status (1)	Package Type	Package Drawing	Pins	Package Qty	Eco Plan (2)	Lead/Ball Finish (6)	MSL Peak Temp (3)	Op Temp (°C)	Device Marking (4/5)	Samples
DS90LT012AHMF	NRND	SOT-23	DBV	5	1000	TBD	Call TI	Call TI	-40 to 125	N05	
DS90LT012AHMF/NOPB	ACTIVE	SOT-23	DBV	5	1000	Green (RoHS & no Sb/Br)	SN	Level-1-260C-UNLIM	-40 to 125	N05	Samples

(1) The marketing status values are defined as follows:

ACTIVE: Product device recommended for new designs.

LIFEBUY: TI has announced that the device will be discontinued, and a lifetime-buy period is in effect.

NRND: Not recommended for new designs. Device is in production to support existing customers, but TI does not recommend using this part in a new design.

PREVIEW: Device has been announced but is not in production. Samples may or may not be available.

OBSOLETE: TI has discontinued the production of the device.

(2) **RoHS:** TI defines "RoHS" to mean semiconductor products that are compliant with the current EU RoHS requirements for all 10 RoHS substances, including the requirement that RoHS substance do not exceed 0.1% by weight in homogeneous materials. Where designed to be soldered at high temperatures, "RoHS" products are suitable for use in specified lead-free processes. TI may reference these types of products as "Pb-Free".

RoHS Exempt: TI defines "RoHS Exempt" to mean products that contain lead but are compliant with EU RoHS pursuant to a specific EU RoHS exemption.

Green: TI defines "Green" to mean the content of Chlorine (Cl) and Bromine (Br) based flame retardants meet JS709B low halogen requirements of <=1000ppm threshold. Antimony trioxide based flame retardants must also meet the <=1000ppm threshold requirement.

(3) MSL, Peak Temp. - The Moisture Sensitivity Level rating according to the JEDEC industry standard classifications, and peak solder temperature.

(4) There may be additional marking, which relates to the logo, the lot trace code information, or the environmental category on the device.

(5) Multiple Device Markings will be inside parentheses. Only one Device Marking contained in parentheses and separated by a "~" will appear on a device. If a line is indented then it is a continuation of the previous line and the two combined represent the entire Device Marking for that device.

(6) Lead/Ball Finish - Orderable Devices may have multiple material finish options. Finish options are separated by a vertical ruled line. Lead/Ball Finish values may wrap to two lines if the finish value exceeds the maximum column width.

Important Information and Disclaimer:The information provided on this page represents TI's knowledge and belief as of the date that it is provided. TI bases its knowledge and belief on information provided by third parties, and makes no representation or warranty as to the accuracy of such information. Efforts are underway to better integrate information from third parties. TI has taken and continues to take reasonable steps to provide representative and accurate information but may not have conducted destructive testing or chemical analysis on incoming materials and chemicals. TI and TI suppliers consider certain information to be proprietary, and thus CAS numbers and other limited information may not be available for release.

In no event shall TI's liability arising out of such information exceed the total purchase price of the TI part(s) at issue in this document sold by TI to Customer on an annual basis.

TAPE AND REEL INFORMATION



QUADRANT ASSIGNMENTS FOR PIN 1 ORIENTATION IN TAPE



*All dimensions are nominal

Device	Package Type	Package Drawing	Pins	SPQ	Reel Diameter (mm)	Reel Width W1 (mm)	A0 (mm)	B0 (mm)	K0 (mm)	P1 (mm)	W (mm)	Pin1 Quadrant
DS90LT012AHMF	SOT-23	DBV	5	1000	178.0	8.4	3.2	3.2	1.4	4.0	8.0	Q3
DS90LT012AHMF/NOPB	SOT-23	DBV	5	1000	178.0	8.4	3.2	3.2	1.4	4.0	8.0	Q3

TAPE AND REEL BOX DIMENSIONS

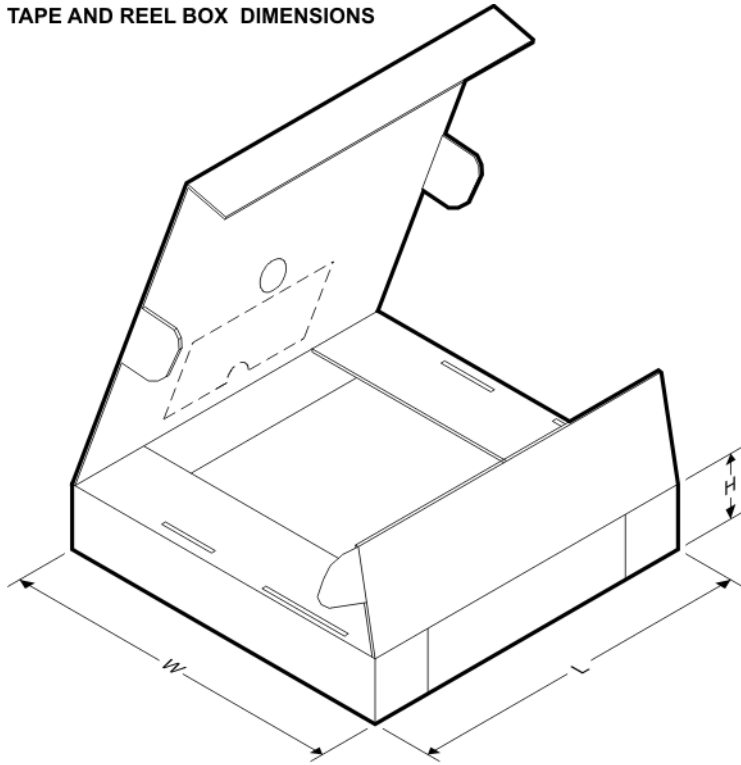

*All dimensions are nominal

Device	Package Type	Package Drawing	Pins	SPQ	Length (mm)	Width (mm)	Height (mm)
DS90LT012AHMF	SOT-23	DBV	5	1000	210.0	185.0	35.0
DS90LT012AHMF/NOPB	SOT-23	DBV	5	1000	210.0	185.0	35.0

EXAMPLE BOARD LAYOUT

DBV0005A

SOT-23 - 1.45 mm max height

SMALL OUTLINE TRANSISTOR

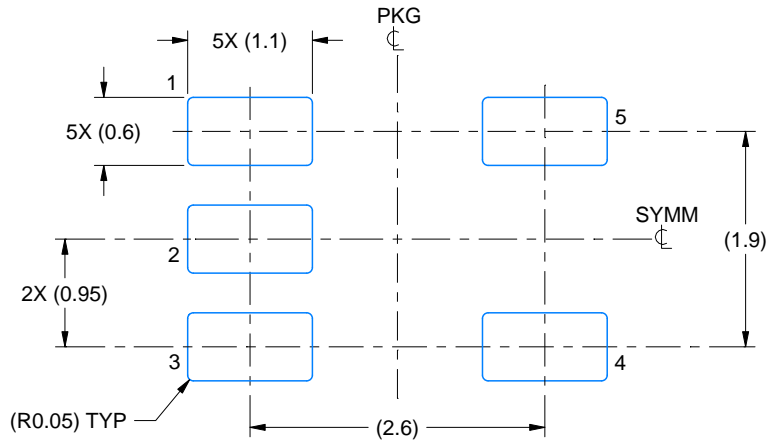

LAND PATTERN EXAMPLE
EXPOSED METAL SHOWN
SCALE:15X

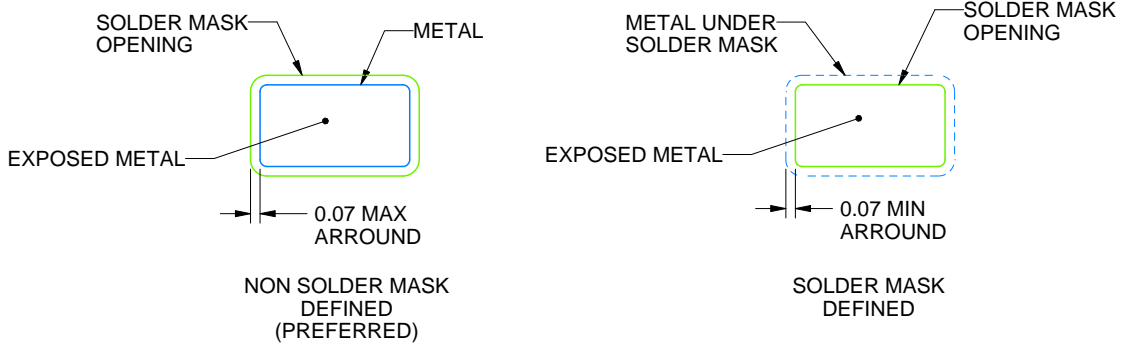

SOLDER MASK DETAILS

4214839/E 09/2019

NOTES: (continued)

- 5. Publication IPC-7351 may have alternate designs.
- 6. Solder mask tolerances between and around signal pads can vary based on board fabrication site.

EXAMPLE STENCIL DESIGN

DBV0005A

SOT-23 - 1.45 mm max height

SMALL OUTLINE TRANSISTOR

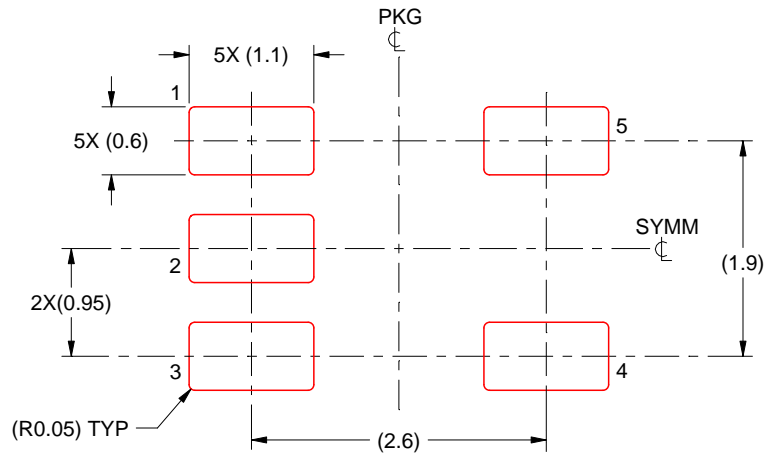

SOLDER PASTE EXAMPLE
BASED ON 0.125 mm THICK STENCIL
SCALE:15X

4214839/E 09/2019

NOTES: (continued)

7. Laser cutting apertures with trapezoidal walls and rounded corners may offer better paste release. IPC-7525 may have alternate design recommendations.
8. Board assembly site may have different recommendations for stencil design.

IMPORTANT NOTICE AND DISCLAIMER

TI PROVIDES TECHNICAL AND RELIABILITY DATA (INCLUDING DATASHEETS), DESIGN RESOURCES (INCLUDING REFERENCE DESIGNS), APPLICATION OR OTHER DESIGN ADVICE, WEB TOOLS, SAFETY INFORMATION, AND OTHER RESOURCES "AS IS" AND WITH ALL FAULTS, AND DISCLAIMS ALL WARRANTIES, EXPRESS AND IMPLIED, INCLUDING WITHOUT LIMITATION ANY IMPLIED WARRANTIES OF MERCHANTABILITY, FITNESS FOR A PARTICULAR PURPOSE OR NON-INFRINGEMENT OF THIRD PARTY INTELLECTUAL PROPERTY RIGHTS.

These resources are intended for skilled developers designing with TI products. You are solely responsible for (1) selecting the appropriate TI products for your application, (2) designing, validating and testing your application, and (3) ensuring your application meets applicable standards, and any other safety, security, or other requirements. These resources are subject to change without notice. TI grants you permission to use these resources only for development of an application that uses the TI products described in the resource. Other reproduction and display of these resources is prohibited. No license is granted to any other TI intellectual property right or to any third party intellectual property right. TI disclaims responsibility for, and you will fully indemnify TI and its representatives against, any claims, damages, costs, losses, and liabilities arising out of your use of these resources.

TI's products are provided subject to TI's Terms of Sale (www.ti.com/legal/termsofsale.html) or other applicable terms available either on ti.com or provided in conjunction with such TI products. TI's provision of these resources does not expand or otherwise alter TI's applicable warranties or warranty disclaimers for TI products.

Mailing Address: Texas Instruments, Post Office Box 655303, Dallas, Texas 75265
Copyright © 2020, Texas Instruments Incorporated