

AP85T03GH/J

RoHS-compliant Product



**Advanced Power
Electronics Corp.**

N-CHANNEL ENHANCEMENT MODE

POWER MOSFET

- ▼ Low Gate Charge
- ▼ Simple Drive Requirement
- ▼ Fast Switching

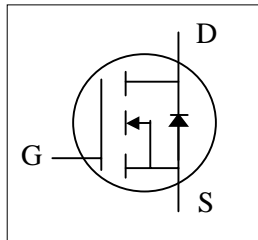

BV_{DSS}	30V
$R_{DS(ON)}$	6m Ω
I_D	75A

Description

The TO-252 package is widely preferred for all commercial-industrial surface mount applications and suited for low voltage applications such as DC/DC converters. The through-hole version (AP85T03GJ) is available for low-profile applications.

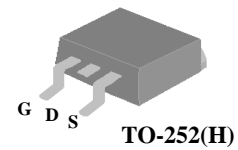

TO-252(H)

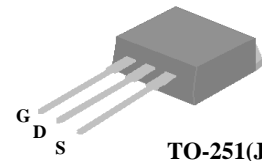

TO-251(J)

Absolute Maximum Ratings

Symbol	Parameter	Rating	Units
V_{DS}	Drain-Source Voltage	30	V
V_{GS}	Gate-Source Voltage	± 20	V
$I_D@T_C=25^\circ C$	Continuous Drain Current, V_{GS} @ 10V	75	A
$I_D@T_C=100^\circ C$	Continuous Drain Current, V_{GS} @ 10V	55	A
I_{DM}	Pulsed Drain Current ¹	350	A
$P_D@T_C=25^\circ C$	Total Power Dissipation	107	W
	Linear Derating Factor	0.7	W/ $^\circ C$
T_{STG}	Storage Temperature Range	-55 to 175	$^\circ C$
T_J	Operating Junction Temperature Range	-55 to 175	$^\circ C$

Thermal Data

Symbol	Parameter	Value	Units
Rthj-c	Maximum Thermal Resistance, Junction-case	1.4	$^\circ C/W$
Rthj-a	Maximum Thermal Resistance, Junction-ambient	110	$^\circ C/W$



AP85T03GH/J

Electrical Characteristics @T_j=25°C(unless otherwise specified)

Symbol	Parameter	Test Conditions	Min.	Typ.	Max.	Units
BV _{DSS}	Drain-Source Breakdown Voltage	V _{GS} =0V, I _D =250uA	30	-	-	V
ΔBV _{DSS} /ΔT _j	Breakdown Voltage Temperature Coefficient	Reference to 25°C, I _D =1mA	-	0.02	-	V/°C
R _{DS(ON)}	Static Drain-Source On-Resistance ²	V _{GS} =10V, I _D =45A	-	-	6	mΩ
		V _{GS} =4.5V, I _D =30A	-	-	10	mΩ
V _{GS(th)}	Gate Threshold Voltage	V _{DS} =V _{GS} , I _D =250uA	1	-	3	V
g _{fs}	Forward Transconductance	V _{DS} =10V, I _D =30A	-	32	-	S
I _{DSS}	Drain-Source Leakage Current	V _{DS} =30V, V _{GS} =0V	-	-	1	uA
	Drain-Source Leakage Current (T _j =175°C)	V _{DS} =24V, V _{GS} =0V	-	-	500	uA
I _{GSS}	Gate-Source Leakage	V _{GS} =±20V	-	-	±100	nA
Q _g	Total Gate Charge ²	I _D =30A	-	33	52	nC
Q _{gs}	Gate-Source Charge	V _{DS} =24V	-	8		nC
Q _{gd}	Gate-Drain ("Miller") Charge	V _{GS} =4.5V	-	24		nC
Q _{oss}	Output Charge	V _{DD} =15V, V _{GS} =0V	-	24.5	39	nC
t _{d(on)}	Turn-on Delay Time ²	V _{DS} =15V	-	11	-	ns
t _r	Rise Time	I _D =30A	-	77	-	ns
t _{d(off)}	Turn-off Delay Time	R _G =3.3Ω, V _{GS} =10V	-	35	-	ns
t _f	Fall Time	R _D =0.5Ω	-	67	-	ns
C _{iss}	Input Capacitance	V _{GS} =0V	-	2700	4200	pF
C _{oss}	Output Capacitance	V _{DS} =25V	-	550	-	pF
C _{rss}	Reverse Transfer Capacitance	f=1.0MHz	-	380	-	pF

Source-Drain Diode

Symbol	Parameter	Test Conditions	Min.	Typ.	Max.	Units
V _{SD}	Forward On Voltage ²	I _S =45A, V _{GS} =0V	-	-	1.3	V
t _{rr}	Reverse Recovery Time ²	I _S =30A, V _{GS} =0V,	-	28	-	ns
Q _{rr}	Reverse Recovery Charge	dI/dt=100A/μs	-	10	-	nC

Notes:

- 1.Pulse width limited by Max. junction temperature.
- 2.Pulse width ≤300us , duty cycle ≤2%.

THIS PRODUCT IS SENSITIVE TO ELECTROSTATIC DISCHARGE, PLEASE HANDLE WITH CAUTION.

USE OF THIS PRODUCT AS A CRITICAL COMPONENT IN LIFE SUPPORT OR OTHER SIMILAR SYSTEMS IS NOT AUTHORIZED.

APEC DOES NOT ASSUME ANY LIABILITY ARISING OUT OF THE APPLICATION OR USE OF ANY PRODUCT OR CIRCUIT DESCRIBED HEREIN; NEITHER DOES IT CONVEY ANY LICENSE UNDER ITS PATENT RIGHTS, NOR THE RIGHTS OF OTHERS.

APEC RESERVES THE RIGHT TO MAKE CHANGES WITHOUT FURTHER NOTICE TO ANY PRODUCTS HEREIN TO IMPROVE RELIABILITY, FUNCTION OR DESIGN.

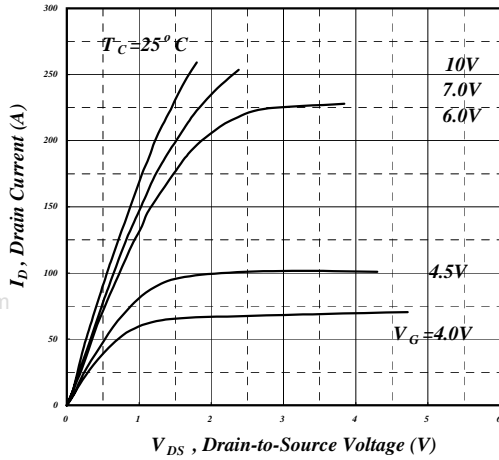

Fig 1. Typical Output Characteristics

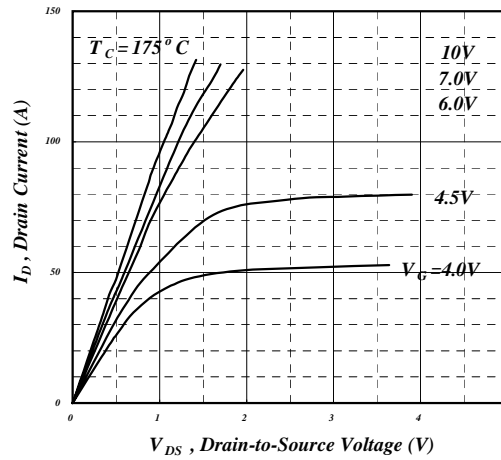

Fig 2. Typical Output Characteristics

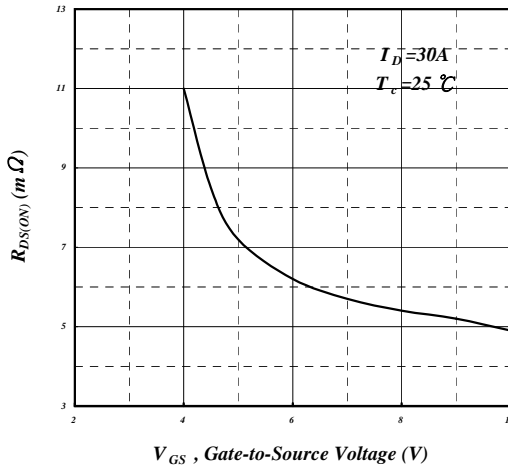

Fig 3. On-Resistance v.s. Gate Voltage

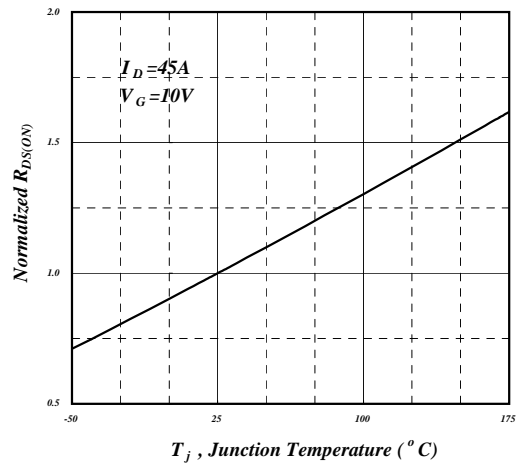

Fig 4. Normalized On-Resistance v.s. Junction Temperature

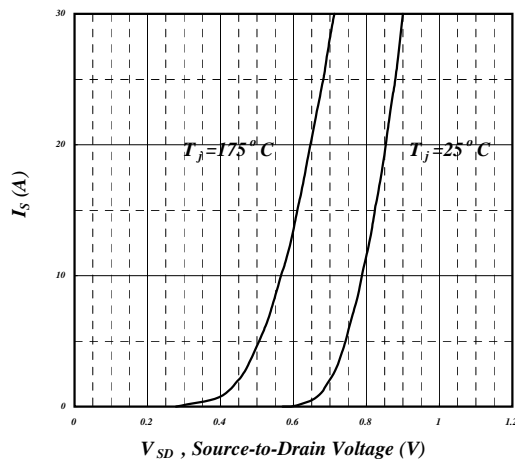

Fig 5. Forward Characteristic of Reverse Diode

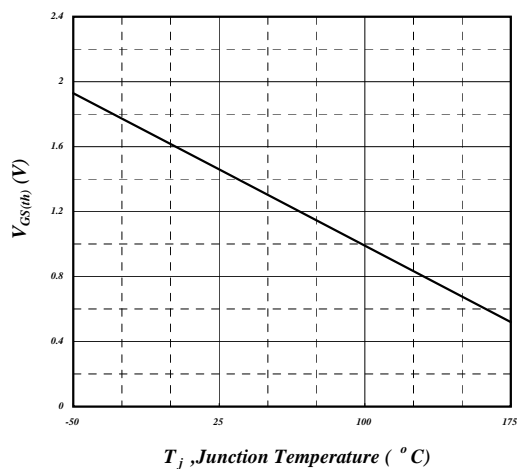

Fig 6. Gate Threshold Voltage v.s. Junction Temperature



AP85T03GH/J

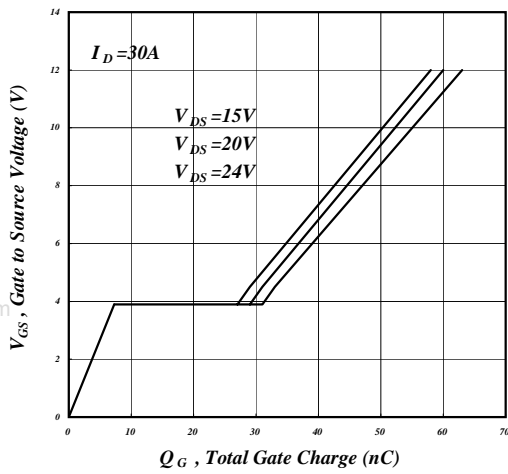

Fig 7. Gate Charge Characteristics

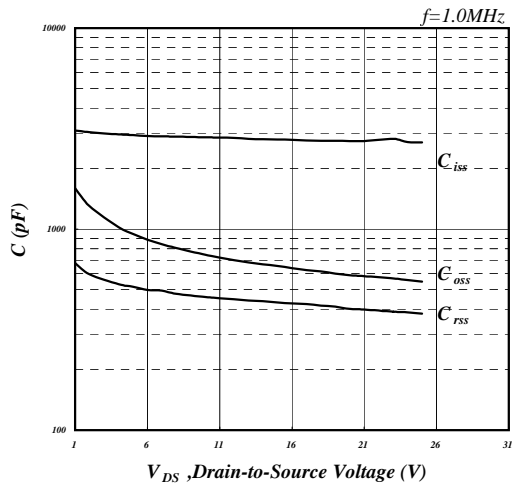

Fig 8. Typical Capacitance Characteristics

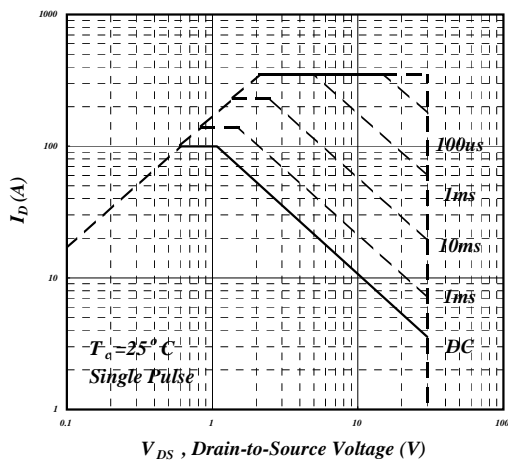

Fig 9. Maximum Safe Operating Area

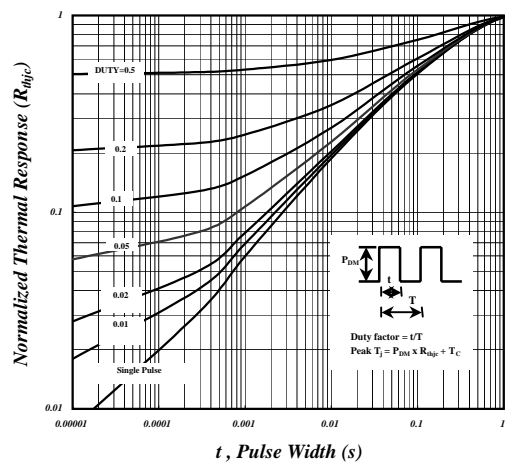

Fig 10. Effective Transient Thermal Impedance

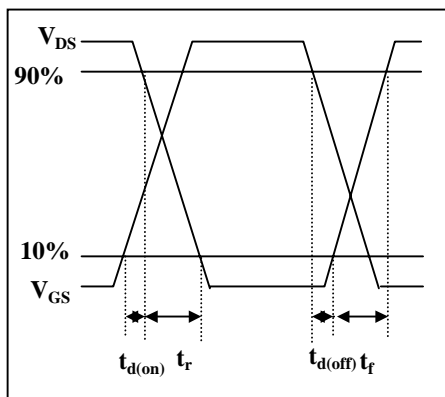

Fig 11. Switching Time Waveform

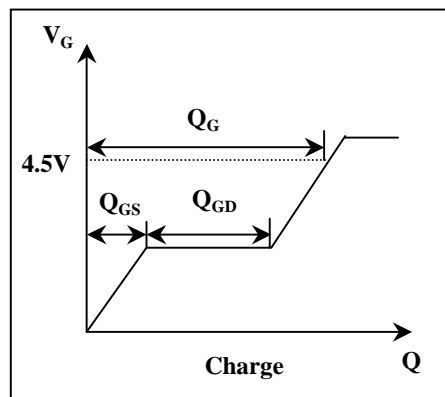
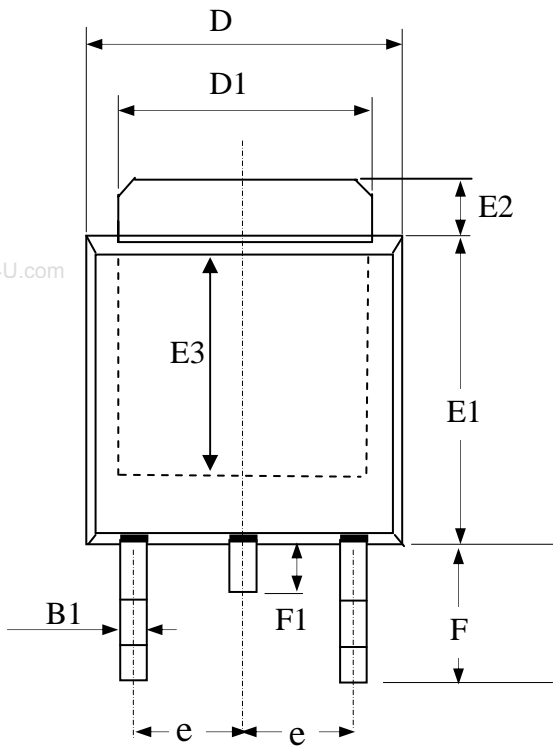

Fig 12. Gate Charge Waveform



Package Outline : TO-252



SYMBOLS	Millimeters		
	MIN	NOM	MAX
A2	1.80	2.30	2.80
A3	0.40	0.50	0.60
B1	0.40	0.70	1.00
D	6.00	6.50	7.00
D1	4.80	5.35	5.90
E3	3.50	4.00	4.50
F	2.20	2.63	3.05
F1	0.5	0.85	1.20
E1	5.10	5.70	6.30
E2	0.50	1.10	1.80
e	--	2.30	--
C	0.35	0.50	0.65

- 1.All Dimensions Are in Millimeters.
- 2.Dimension Does Not Include Mold Protrusions.



Part Marking Information & Packing : TO-252

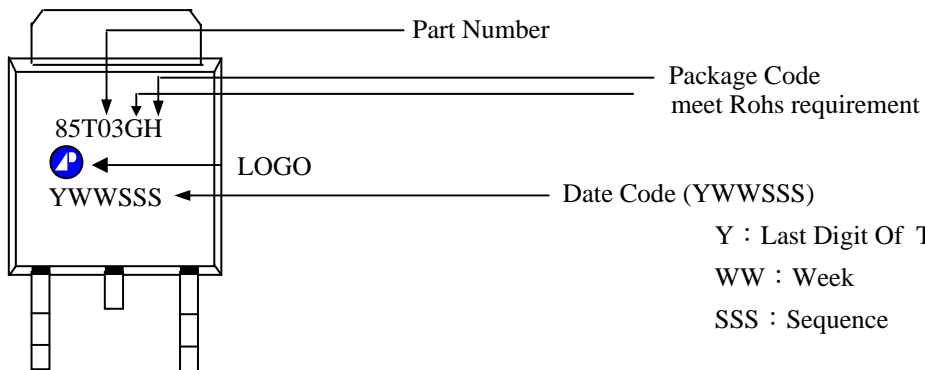



Package Outline : TO-251

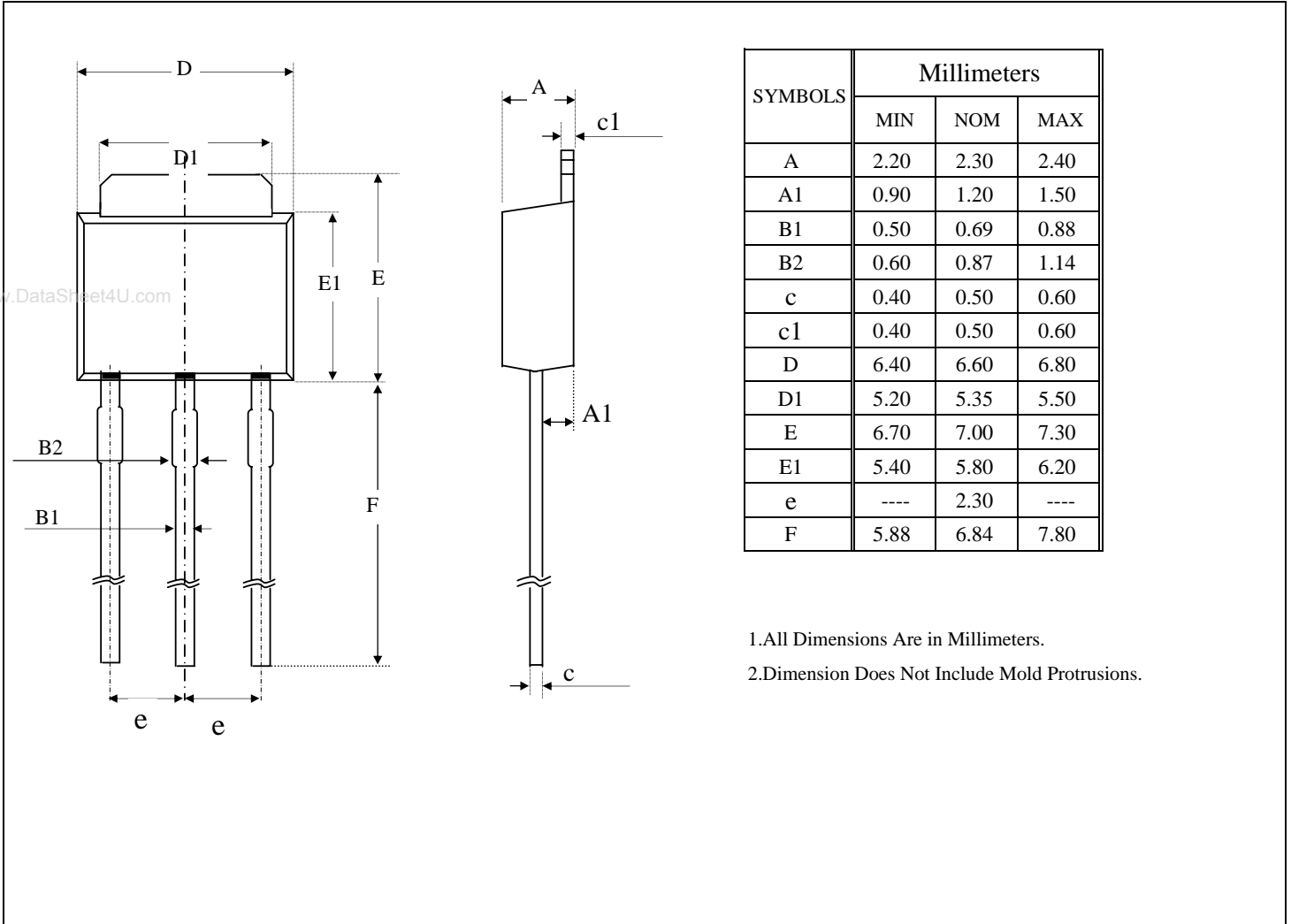

Part Marking Information & Packing : TO-251

