

HIGH VOLTAGE FASTSWITCHING NPN POWER TRANSISTOR

- SGS-THOMSON PREFERRED SALESTYPE
- HIGH VOLTAGE CAPABILITY
- U.L. RECOGNISED ISOWATT218 PACKAGE (U.L. FILE # E81734 (N))

APPLICATIONS:

- HORIZONTAL DEFLECTION FOR COLOUR TVS AND MONITORS
- SWITCH MODE POWER SUPPLIES

DESCRIPTION

The BUH series is designed for use in horizontal deflection circuits in televisions and monitors.

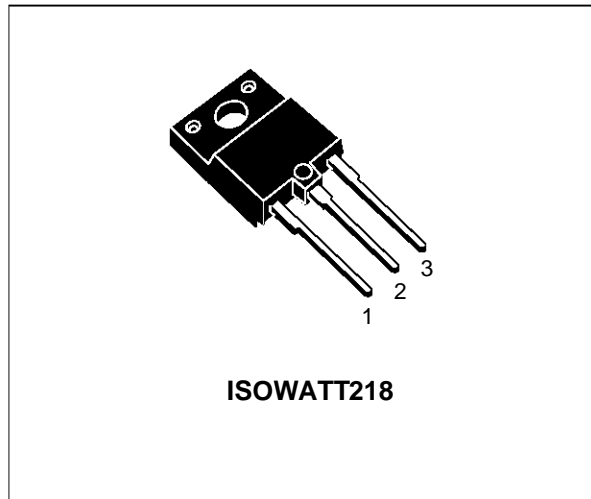
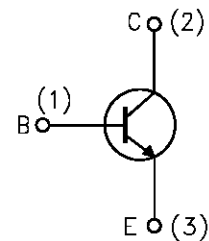
INTERNAL SCHEMATIC DIAGRAM

SC06960
ABSOLUTE MAXIMUM RATINGS

Symbol	Parameter	Value	Unit
V_{CBO}	Collector-Base Voltage ($I_E = 0$)	1300	V
V_{CEO}	Collector-Emitter Voltage ($I_B = 0$)	700	V
V_{EBO}	Emitter-Base Voltage ($I_C = 0$)	10	V
I_C	Collector Current	8	A
I_{CM}	Collector Peak Current ($t_p < 5$ ms)	12	A
I_B	Base Current	5	A
I_{BM}	Base Peak Current ($t_p < 5$ ms)	8	A
P_{tot}	Total Dissipation at $T_C = 25$ °C	50	W
T_{stg}	Storage Temperature	-65 to 150	°C
T_j	Max. Operating Junction Temperature	150	°C

THERMAL DATA

R _{thj-case}	Thermal Resistance Junction-case	Max	2.5	°C/W
-----------------------	----------------------------------	-----	-----	------

ELECTRICAL CHARACTERISTICS (T_{case} = 25 °C unless otherwise specified)

Symbol	Parameter	Test Conditions	Min.	Typ.	Max.	Unit
I _{CES}	Collector Cut-off Current (V _{BE} = 0)	V _{CE} = 1300 V V _{CE} = 1300 V T _j = 125 °C			1 2	mA mA
I _{EBO}	Emitter Cut-off Current (I _C = 0)	V _{EB} = 5 V			100	μA
V _{CEO(sus)}	Collector-Emitter Sustaining Voltage	I _C = 100 mA	700			V
V _{EBO}	Emitter-Base Voltage (I _C = 0)	I _E = 10 mA	10			V
V _{CE(sat)*}	Collector-Emitter Saturation Voltage	I _C = 5 A I _B = 1.25 A			1.5	V
V _{BE(sat)*}	Base-Emitter Saturation Voltage	I _C = 5 A I _B = 1.25 A			1.3	V
h _{FE*}	DC Current Gain	I _C = 5 A V _{CE} = 5 V I _C = 5 A V _{CE} = 5 V T _j = 100 °C	6 4			
t _s t _f	RESISTIVE LOAD Storage Time Fall Time	V _{CC} = 400 V I _C = 5 A I _{B1} = 1.25 A I _{B2} = 2.5 A		2.7 190	3.9 280	μs ns
t _s t _f	INDUCTIVE LOAD Storage Time Fall Time	I _C = 5 A f = 15625 Hz I _{B1} = 1.25 A I _{B2} = -2.5 A V _{ceflyback} = 1050 sin(π/10 10 ⁶) t V		2.3 350		μs ns
t _s t _f	INDUCTIVE LOAD Storage Time Fall Time	I _C = 5 A f = 31250 Hz I _{B1} = 1.25 A I _{B2} = -2.5 A V _{ceflyback} = 1200 sin(π/5 10 ⁶) t V		2.3 200		μs ns

* Pulsed: Pulse duration = 300 μs, duty cycle 1.5 %

Safe Operating Area

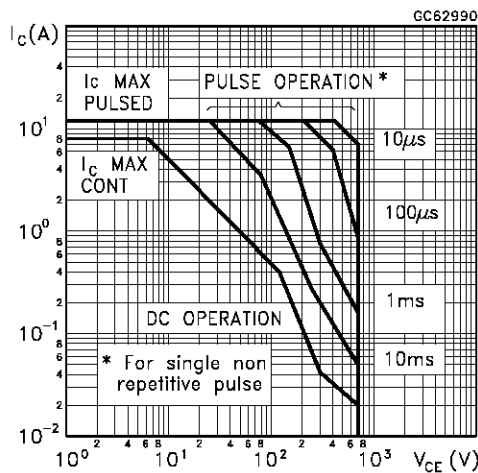

Thermal Impedance

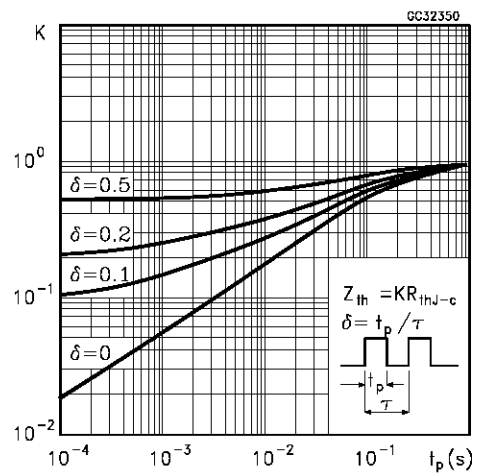

Derating Curve

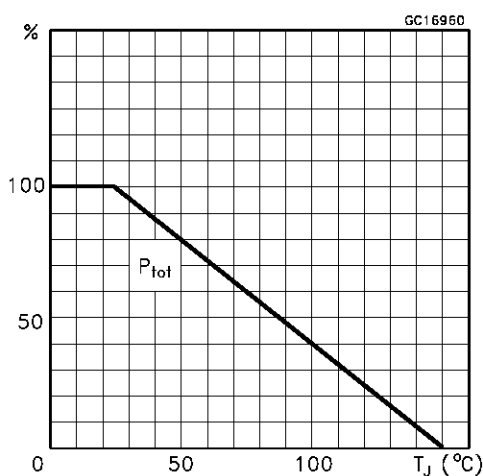

DC Current Gain

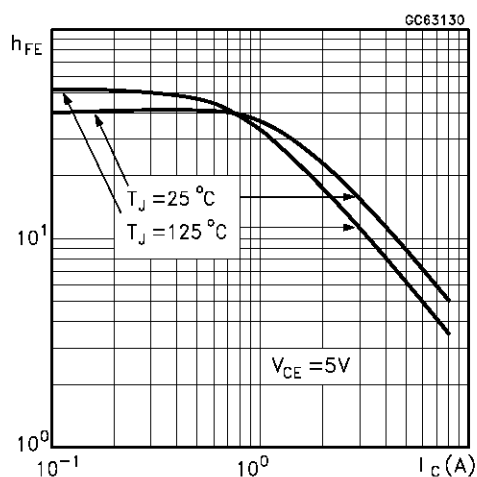

Collector Emitter Saturation Voltage

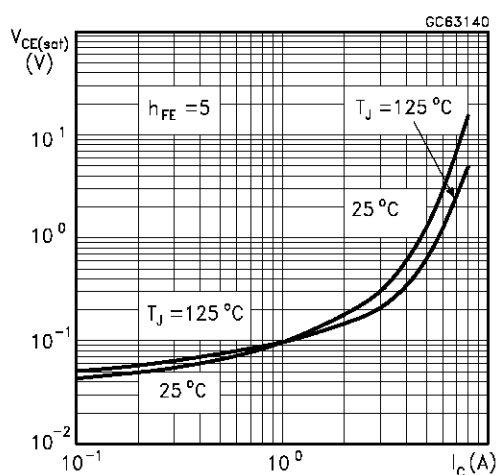

Base Emitter Saturation Voltage

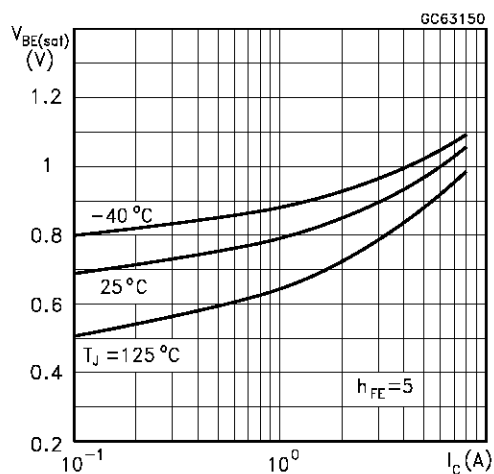

Power Losses at 16 KHz

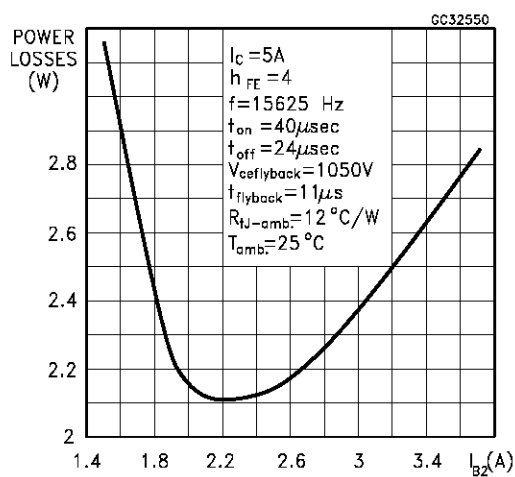

Switching Time Inductive Load at 16KHz
(see figure 2)

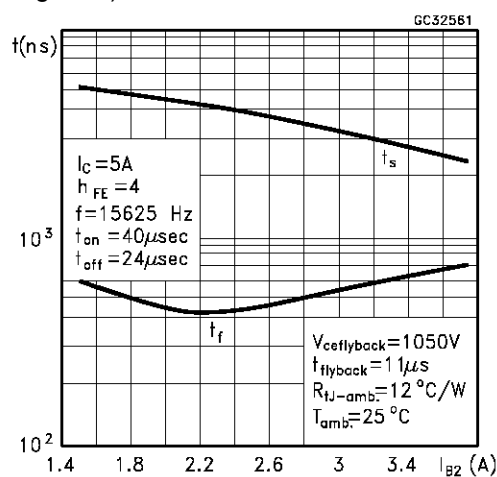

Power Losses at 32 KHz

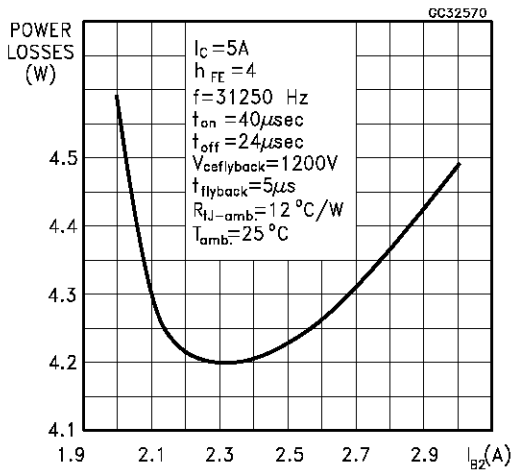

Switching Time Inductive Load at 32 KHz (see figure 2)

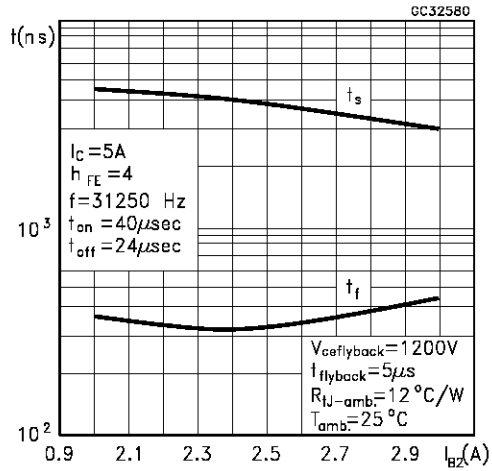

Reverse Biased SOA

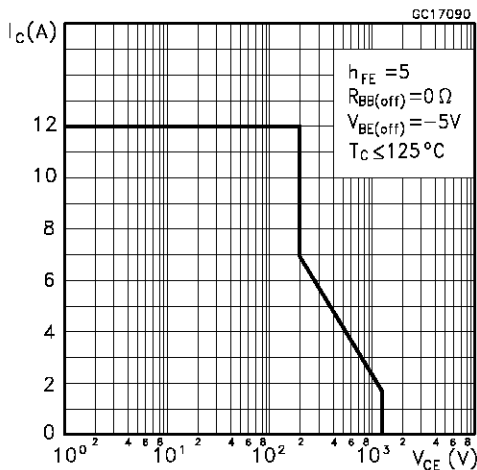

Switching Time Resistive Load

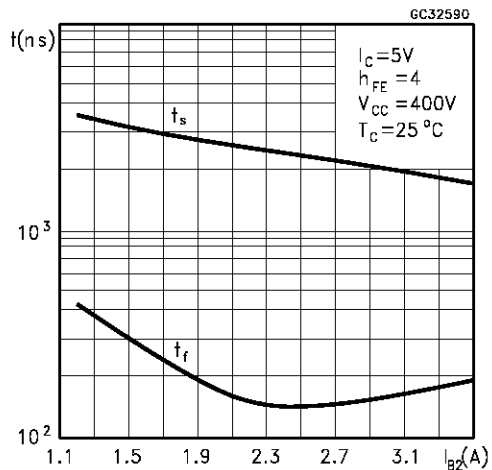

BASE DRIVE INFORMATION

In order to saturate the power switch and reduce conduction losses, adequate direct base current I_{B1} has to be provided for the lowest gain h_{FE} at 100 °C (line scan phase). On the other hand, negative base current I_{B2} must be provided to turn off the power transistor (retrace phase).

Most of the dissipation, in the deflection application, occurs at switch-off. Therefore it is essential to determine the value of I_{B2} which minimizes power losses, fall time t_f and, consequently, T_j . A new set of curves have been defined to give total power losses, t_s and t_f as a function of I_{B2} at both 16 KHz and 32 KHz scanning frequencies for choosing the optimum negative drive. The test circuit is illustrated in

figure 1.

Inductance L_1 serves to control the slope of the negative base current I_{B2} to recombine the excess carrier in the collector when base current is still present, this would avoid any tailing phenomenon in the collector current.

The values of L and C are calculated from the following equations:

$$\frac{1}{2} L (I_C)^2 = \frac{1}{2} C (V_{CEfly})^2 \quad \omega = 2 \pi f = \frac{1}{\sqrt{LC}}$$

Where I_C = operating collector current, V_{CEfly} = flyback voltage, f = frequency of oscillation during retrace.

Figure 1: Inductive Load Switching Test Circuits.

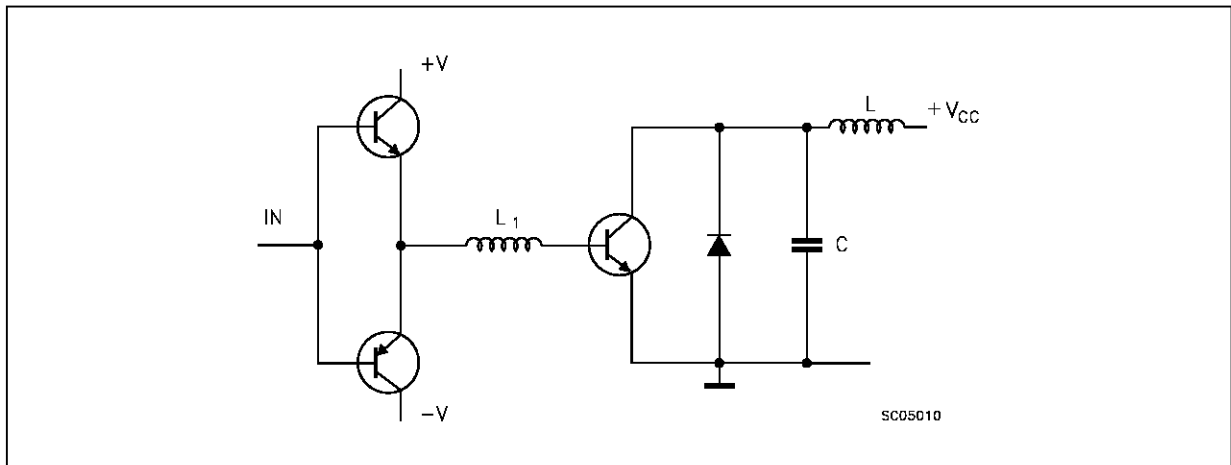
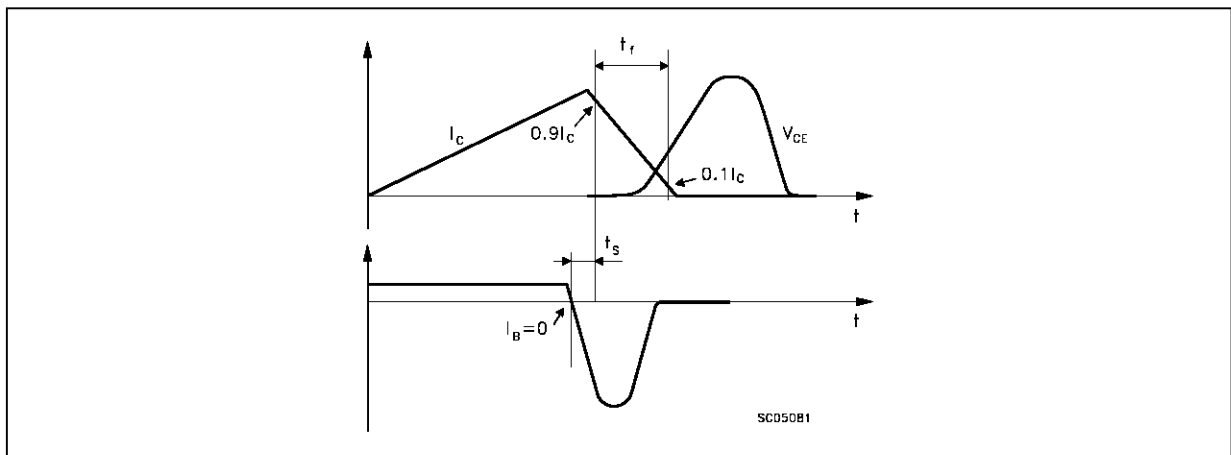
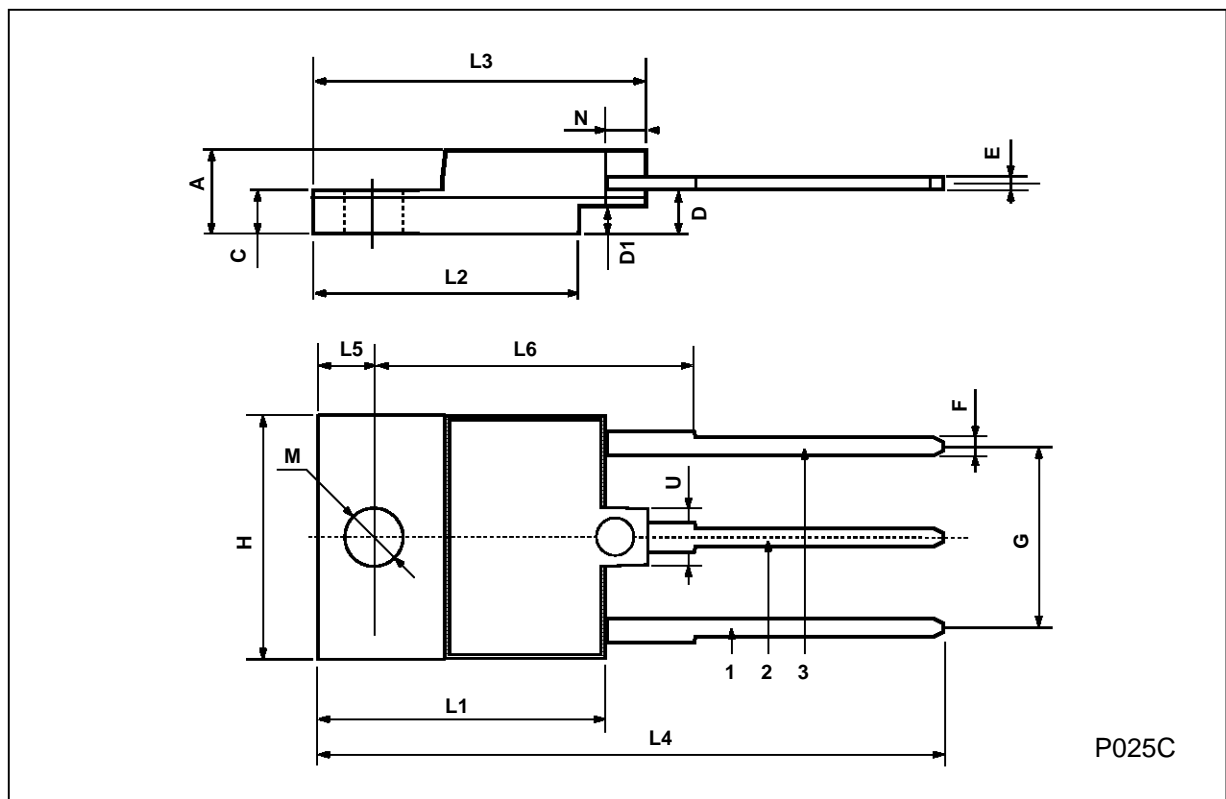

Figure 2: Switching Waveforms in a Deflection Circuit



ISOWATT218 MECHANICAL DATA

DIM.	mm			inch		
	MIN.	TYP.	MAX.	MIN.	TYP.	MAX.
A	5.35		5.65	0.210		0.222
C	3.3		3.8	0.130		0.149
D	2.9		3.1	0.114		0.122
D1	1.88		2.08	0.074		0.081
E	0.45		1	0.017		0.039
F	1.05		1.25	0.041		0.049
G	10.8		11.2	0.425		0.441
H	15.8		16.2	0.622		0.637
L1	20.8		21.2	0.818		0.834
L2	19.1		19.9	0.752		0.783
L3	22.8		23.6	0.897		0.929
L4	40.5		42.5	1.594		1.673
L5	4.85		5.25	0.190		0.206
L6	20.25		20.75	0.797		0.817
M	3.5		3.7	0.137		0.145
N	2.1		2.3	0.082		0.090
U		4.6			0.181	



Information furnished is believed to be accurate and reliable. However, SGS-THOMSON Microelectronics assumes no responsibility for the consequences of use of such information nor for any infringement of patents or other rights of third parties which may result from its use. No license is granted by implication or otherwise under any patent or patent rights of SGS-THOMSON Microelectronics. Specifications mentioned in this publication are subject to change without notice. This publication supersedes and replaces all information previously supplied. SGS-THOMSON Microelectronics products are not authorized for use as critical components in life support devices or systems without express written approval of SGS-THOMSON Microelectronics.

© 1996 SGS-THOMSON Microelectronics - Printed in Italy - All Rights Reserved

SGS-THOMSON Microelectronics GROUP OF COMPANIES

Australia - Brazil - Canada - China - France - Germany - Hong Kong - Italy - Japan - Korea - Malaysia - Malta - Morocco - The Netherlands - Singapore - Spain - Sweden - Switzerland - Taiwan - Thailand - United Kingdom - U.S.A