

74HC2G17; 74HCT2G17

Dual non-inverting Schmitt trigger

Rev. 01 — 6 October 2006

Product data sheet

1. General description

The 74HC2G17; 74HCT2G17 is a high-speed Si-gate CMOS device.

The 74HC2G17; 74HCT2G17 provides two non-inverting Schmitt trigger buffers. They are capable of transforming slowly changing input signals into sharply defined, jitter-free output signals.

The inputs switch at different points for positive and negative-going signals. The difference between the positive voltage V_{T+} and the negative voltage V_{T-} is defined as the input hysteresis voltage V_H .

2. Features

- Wide supply voltage range from 2.0 V to 6.0 V
- Complies with JEDEC standard no. 7A
- High noise immunity
- ESD protection:
 - ◆ HBM JESD22-A114-D exceeds 2000 V
 - ◆ MM JESD22-A115-A exceeds 200 V
- Low power dissipation
- Balanced propagation delays
- Unlimited input rise and fall times
- Multiple package options
- Specified from $-40\text{ }^{\circ}\text{C}$ to $+85\text{ }^{\circ}\text{C}$ and $-40\text{ }^{\circ}\text{C}$ to $+125\text{ }^{\circ}\text{C}$

3. Applications

- Wave and pulse shaper for highly noisy environments
- Astable multivibrators
- Monostable multivibrators

4. Ordering information

Table 1. Ordering information

Type number	Package			Version
	Temperature range	Name	Description	
74HC2G17GW	-40 °C to +125 °C	SC-88	plastic surface-mounted package; 6 leads	SOT363
74HC2G17GV	-40 °C to +125 °C	SC-74	plastic surface-mounted package (TSOP6); 6 leads	SOT457
74HCT2G17GW	-40 °C to +125 °C	SC-88	plastic surface-mounted package; 6 leads	SOT363
74HCT2G17GV	-40 °C to +125 °C	SC-74	plastic surface-mounted package (TSOP6); 6 leads	SOT457

5. Marking

Table 2. Marking

Type number	Marking code
74HC2G17GW	HV
74HC2G17GV	HV
74HCT2G17GW	TV
74HCT2G17GV	TV

6. Functional diagram

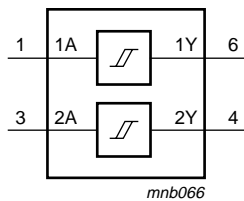

Fig 1. Logic symbol

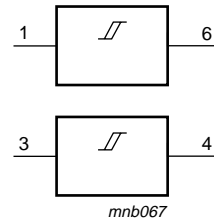

Fig 2. IEC logic symbol

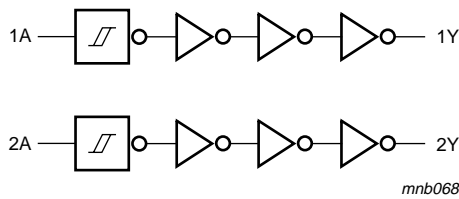

Fig 3. Logic diagram

7. Pinning information

7.1 Pinning

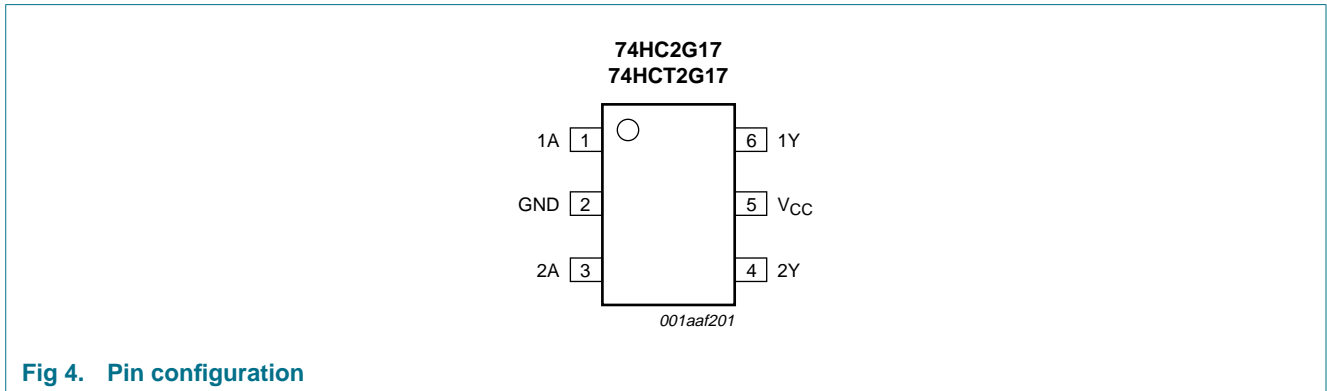

Fig 4. Pin configuration

7.2 Pin description

Table 3. Pin description

Symbol	Pin	Description
1A	1	data input
GND	2	ground (0 V)
2A	3	data input
2Y	4	data output
V _{CC}	5	supply voltage
1Y	6	data output

8. Functional description

Table 4. Function table^[1]

Input	Output
nA	nY
L	L
H	H

[1] H = HIGH voltage level;
L = LOW voltage level.

9. Limiting values

Table 5. Limiting values

In accordance with the Absolute Maximum Rating System (IEC 60134). Voltages are referenced to GND (ground = 0 V).

Symbol	Parameter	Conditions	Min	Max	Unit
V_{CC}	supply voltage		-0.5	+7.0	V
I_{IK}	input clamping current	$V_I < -0.5\text{ V}$ or $V_I > V_{CC} + 0.5\text{ V}$	[1] -	±20	mA
I_{OK}	output clamping current	$V_O < -0.5\text{ V}$ or $V_O > V_{CC} + 0.5\text{ V}$	[1] -	±20	mA
I_O	output current	$V_O = -0.5\text{ V}$ to $V_{CC} + 0.5\text{ V}$	[1] -	±25	mA
I_{CC}	supply current		[1] -	50	mA
I_{GND}	ground current		[1] -	-50	mA
T_{stg}	storage temperature		-65	+150	°C
P_{tot}	total power dissipation		[2] -	250	mW

[1] The minimum input and output voltage ratings may be exceeded if the input and output current ratings are observed.

[2] For SC-88 and SC-74 packages: above 87.5 °C the value of P_{tot} derates linearly with 4.0 mW/K.

10. Recommended operating conditions

Table 6. Recommended operating conditions

Symbol	Parameter	Conditions	Min	Typ	Max	Unit
Type 74HC2G17						
V_{CC}	supply voltage		2.0	5.0	6.0	V
V_I	input voltage		0	-	V_{CC}	V
V_O	output voltage		0	-	V_{CC}	V
T_{amb}	ambient temperature		-40	+25	+125	°C
Type 74HCT2G17						
V_{CC}	supply voltage		4.5	5.0	5.5	V
V_I	input voltage		0	-	V_{CC}	V
V_O	output voltage		0	-	V_{CC}	V
T_{amb}	ambient temperature		-40	+25	+125	°C

11. Static characteristics

Table 7. Static characteristics for 74HC2G17

At recommended operating conditions; voltages are referenced to GND (ground = 0 V).

Symbol	Parameter	Conditions	Min	Typ	Max	Unit
$T_{amb} = 25\text{ °C}$						
V_{OH}	HIGH-level output voltage	$V_I = V_{IH}$ or V_{IL}				
		$I_O = -20\text{ }\mu\text{A}$; $V_{CC} = 2.0\text{ V}$	1.9	2.0	-	V
		$I_O = -20\text{ }\mu\text{A}$; $V_{CC} = 4.5\text{ V}$	4.4	4.5	-	V
		$I_O = -20\text{ }\mu\text{A}$; $V_{CC} = 6.0\text{ V}$	5.9	6.0	-	V
		$I_O = -4.0\text{ mA}$; $V_{CC} = 4.5\text{ V}$	4.18	4.32	-	V
		$I_O = -5.2\text{ mA}$; $V_{CC} = 6.0\text{ V}$	5.68	5.81	-	V

Table 7. Static characteristics for 74HC2G17 ...continued

At recommended operating conditions; voltages are referenced to GND (ground = 0 V).

Symbol	Parameter	Conditions	Min	Typ	Max	Unit
V_{OL}	LOW-level output voltage	$V_I = V_{IH}$ or V_{IL}				
		$I_O = 20 \mu\text{A}; V_{CC} = 2.0 \text{ V}$	-	0	0.1	V
		$I_O = 20 \mu\text{A}; V_{CC} = 4.5 \text{ V}$	-	0	0.1	V
		$I_O = 20 \mu\text{A}; V_{CC} = 6.0 \text{ V}$	-	0	0.1	V
		$I_O = 4.0 \text{ mA}; V_{CC} = 4.5 \text{ V}$	-	0.15	0.26	V
		$I_O = 5.2 \text{ mA}; V_{CC} = 6.0 \text{ V}$	-	0.16	0.26	V
I_I	input leakage current	$V_I = \text{GND}$ or $V_{CC}; V_{CC} = 6.0 \text{ V}$	-	-	± 0.1	μA
I_{CC}	supply current	$V_I = \text{GND}$ or $V_{CC}; I_O = 0 \text{ A}; V_{CC} = 6.0 \text{ V}$	-	-	1.0	μA
C_I	input capacitance		-	2.0	-	pF
$T_{\text{amb}} = -40 \text{ }^\circ\text{C}$ to $+85 \text{ }^\circ\text{C}$						
V_{OH}	HIGH-level output voltage	$V_I = V_{IH}$ or V_{IL}				
		$I_O = -20 \mu\text{A}; V_{CC} = 2.0 \text{ V}$	1.9	-	-	V
		$I_O = -20 \mu\text{A}; V_{CC} = 4.5 \text{ V}$	4.4	-	-	V
		$I_O = -20 \mu\text{A}; V_{CC} = 6.0 \text{ V}$	5.9	-	-	V
		$I_O = -4.0 \text{ mA}; V_{CC} = 4.5 \text{ V}$	4.13	-	-	V
		$I_O = -5.2 \text{ mA}; V_{CC} = 6.0 \text{ V}$	5.63	-	-	V
V_{OL}	LOW-level output voltage	$V_I = V_{IH}$ or V_{IL}				
		$I_O = 20 \mu\text{A}; V_{CC} = 2.0 \text{ V}$	-	-	0.1	V
		$I_O = 20 \mu\text{A}; V_{CC} = 4.5 \text{ V}$	-	-	0.1	V
		$I_O = 20 \mu\text{A}; V_{CC} = 6.0 \text{ V}$	-	-	0.1	V
		$I_O = 4.0 \text{ mA}; V_{CC} = 4.5 \text{ V}$	-	-	0.33	V
		$I_O = 5.2 \text{ mA}; V_{CC} = 6.0 \text{ V}$	-	-	0.33	V
I_I	input leakage current	$V_I = \text{GND}$ or $V_{CC}; V_{CC} = 6.0 \text{ V}$	-	-	± 1.0	μA
I_{CC}	supply current	$V_I = \text{GND}$ or $V_{CC}; I_O = 0 \text{ A}; V_{CC} = 6.0 \text{ V}$	-	-	10.0	μA
$T_{\text{amb}} = -40 \text{ }^\circ\text{C}$ to $+125 \text{ }^\circ\text{C}$						
V_{OH}	HIGH-level output voltage	$V_I = V_{IH}$ or V_{IL}				
		$I_O = -20 \mu\text{A}; V_{CC} = 2.0 \text{ V}$	1.9	-	-	V
		$I_O = -20 \mu\text{A}; V_{CC} = 4.5 \text{ V}$	4.4	-	-	V
		$I_O = -20 \mu\text{A}; V_{CC} = 6.0 \text{ V}$	5.9	-	-	V
		$I_O = -4.0 \text{ mA}; V_{CC} = 4.5 \text{ V}$	3.7	-	-	V
		$I_O = -5.2 \text{ mA}; V_{CC} = 6.0 \text{ V}$	5.2	-	-	V

Table 7. Static characteristics for 74HC2G17 ...continued

At recommended operating conditions; voltages are referenced to GND (ground = 0 V).

Symbol	Parameter	Conditions	Min	Typ	Max	Unit
V_{OL}	LOW-level output voltage	$V_I = V_{IH}$ or V_{IL}				
		$I_O = 20 \mu\text{A}; V_{CC} = 2.0 \text{ V}$	-	-	0.1	V
		$I_O = 20 \mu\text{A}; V_{CC} = 4.5 \text{ V}$	-	-	0.1	V
		$I_O = 20 \mu\text{A}; V_{CC} = 6.0 \text{ V}$	-	-	0.1	V
		$I_O = 4.0 \text{ mA}; V_{CC} = 4.5 \text{ V}$	-	-	0.4	V
		$I_O = 5.2 \text{ mA}; V_{CC} = 6.0 \text{ V}$	-	-	0.4	V
I_I	input leakage current	$V_I = \text{GND}$ or $V_{CC}; V_{CC} = 6.0 \text{ V}$	-	-	± 1.0	μA
I_{CC}	supply current	$V_I = \text{GND}$ or $V_{CC}; I_O = 0 \text{ A}; V_{CC} = 6.0 \text{ V}$	-	-	20.0	μA

Table 8. Static characteristics for 74HCT2G17

At recommended operating conditions; voltages are referenced to GND (ground = 0 V).

Symbol	Parameter	Conditions	Min	Typ	Max	Unit
$T_{amb} = 25 \text{ }^\circ\text{C}$						
V_{OH}	HIGH-level output voltage	$V_I = V_{IH}$ or $V_{IL}; V_{CC} = 4.5 \text{ V}$				
		$I_O = -20 \mu\text{A}$	4.4	4.5	-	V
		$I_O = -4.0 \text{ mA}$	4.18	4.32	-	V
V_{OL}	LOW-level output voltage	$V_I = V_{IH}$ or $V_{IL}; V_{CC} = 4.5 \text{ V}$				
		$I_O = -20 \mu\text{A}$	-	0	0.1	V
		$I_O = -4.0 \text{ mA}$	-	0.15	0.26	V
I_I	input leakage current	$V_I = \text{GND}$ or $V_{CC}; V_{CC} = 5.5 \text{ V}$	-	-	± 0.1	μA
I_{CC}	supply current	$V_I = \text{GND}$ or $V_{CC}; I_O = 0 \text{ A}; V_{CC} = 5.5 \text{ V}$	-	-	1.0	μA
ΔI_{CC}	additional supply current	$V_I = V_{CC} - 2.1 \text{ V}; V_{CC} = 4.5 \text{ V to } 5.5 \text{ V}; I_O = 0 \text{ A}$	-	-	300	μA
C_I	input capacitance		-	2.0	-	pF
$T_{amb} = -40 \text{ }^\circ\text{C to } +85 \text{ }^\circ\text{C}$						
V_{OH}	HIGH-level output voltage	$V_I = V_{IH}$ or $V_{IL}; V_{CC} = 4.5 \text{ V}$				
		$I_O = -20 \mu\text{A}$	4.4	-	-	V
		$I_O = -4.0 \text{ mA}$	4.13	-	-	V
V_{OL}	LOW-level output voltage	$V_I = V_{IH}$ or $V_{IL}; V_{CC} = 4.5 \text{ V}$				
		$I_O = -20 \mu\text{A}$	-	-	0.1	V
		$I_O = -4.0 \text{ mA}$	-	-	0.33	V
I_I	input leakage current	$V_I = \text{GND}$ or $V_{CC}; V_{CC} = 5.5 \text{ V}$	-	-	± 1.0	μA
I_{CC}	supply current	$V_I = \text{GND}$ or $V_{CC}; I_O = 0 \text{ A}; V_{CC} = 5.5 \text{ V}$	-	-	10.0	μA
ΔI_{CC}	additional supply current	$V_I = V_{CC} - 2.1 \text{ V}; V_{CC} = 4.5 \text{ V to } 5.5 \text{ V}; I_O = 0 \text{ A}$	-	-	375	μA

Table 8. Static characteristics for 74HCT2G17 ...continued

At recommended operating conditions; voltages are referenced to GND (ground = 0 V).

Symbol	Parameter	Conditions	Min	Typ	Max	Unit
T_{amb} = -40 °C to +125 °C						
V _{OH}	HIGH-level output voltage	V _I = V _{IH} or V _{IL} ; V _{CC} = 4.5 V				
		I _O = -20 μA	4.4	-	-	V
		I _O = -4.0 mA	3.7	-	-	V
V _{OL}	LOW-level output voltage	V _I = V _{IH} or V _{IL} ; V _{CC} = 4.5 V				
		I _O = -20 μA	-	-	0.1	V
		I _O = -4.0 mA	-	-	0.4	V
I _I	input leakage current	V _I = GND or V _{CC} ; V _{CC} = 5.5 V	-	-	±1.0	μA
I _{CC}	supply current	V _I = GND or V _{CC} ; I _O = 0 A; V _{CC} = 5.5 V	-	-	20.0	μA
ΔI _{CC}	additional supply current	V _I = V _{CC} - 2.1 V; V _{CC} = 4.5 V to 5.5 V; I _O = 0 A	-	-	410	μA

12. Dynamic characteristics

Table 9. Dynamic characteristicsVoltages are referenced to GND (ground = 0 V); for test circuit see [Figure 6](#).

Symbol	Parameter	Conditions	25 °C			-40 °C to +125 °C			Unit
			Min	Typ	Max	Min	Max (85 °C)	Max (125 °C)	
74HC2G17									
t _{pd}	propagation delay	nA to nY; see Figure 5 [1]							
		V _{CC} = 2.0 V; C _L = 50 pF	-	36	115	-	140	175	ns
		V _{CC} = 4.5 V; C _L = 50 pF	-	12	22	-	27	34	ns
		V _{CC} = 6.0 V; C _L = 50 pF	-	10	18	-	22	28	ns
t _t	transition time	nY; see Figure 5 [2]							
		V _{CC} = 2.0 V; C _L = 50 pF	-	20	75	-	95	110	ns
		V _{CC} = 4.5 V; C _L = 50 pF	-	7	15	-	19	22	ns
		V _{CC} = 6.0 V; C _L = 50 pF	-	5	13	-	16	19	ns
C _{PD}	power dissipation capacitance	V _I = GND to V _{CC} [3]	-	10	-	-	-	-	pF

Table 9. Dynamic characteristics ...continued

Voltages are referenced to GND (ground = 0 V); for test circuit see [Figure 6](#).

Symbol	Parameter	Conditions	25 °C			-40 °C to +125 °C			Unit	
			Min	Typ	Max	Min	Max (85 °C)	Max (125 °C)		
74HCT2G17										
t_{pd}	propagation delay	nA to nY; see Figure 5 $V_{CC} = 4.5\text{ V}; C_L = 50\text{ pF}$	[1]	-	21	29	-	36	45	ns
t_t	transition time	nY; see Figure 5 $V_{CC} = 4.5\text{ V}; C_L = 50\text{ pF}$	[2]	-	6	15	-	19	22	ns
C_{PD}	power dissipation capacitance	$V_I = \text{GND to } V_{CC} - 1.5\text{ V}$	[3]	-	10	-	-	-	-	pF

[1] t_{pd} is the same as t_{PLH} and t_{PHL}

[2] t_t is the same as t_{TLH} and t_{THL}

[3] C_{PD} is used to determine the dynamic power dissipation (P_D in μW).

$$P_D = C_{PD} \times V_{CC}^2 \times f_i \times N + \Sigma(C_L \times V_{CC}^2 \times f_o) \text{ where:}$$

f_i = input frequency in MHz;

f_o = output frequency in MHz;

C_L = output load capacitance in pF;

V_{CC} = supply voltage in V;

N = number of inputs switching;

$\Sigma(C_L \times V_{CC}^2 \times f_o)$ = sum of the outputs.

13. Waveforms

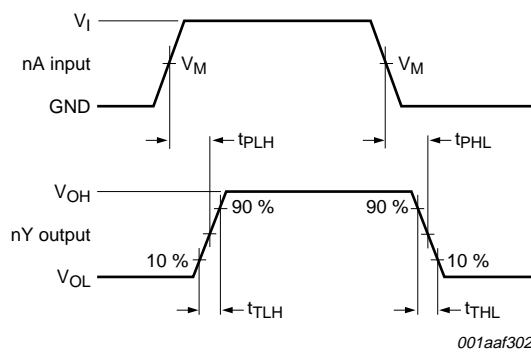

Measurement points are given in [Table 10](#).

V_{OL} and V_{OH} are typical voltage output drop that occur with the output load.

Fig 5. The data input (nA) to output (nY) propagation delays and output transition times

Table 10. Measurement points

Type	Input			Output
	V_M	V_I	$t_r = t_f$	V_M
74HC2G17	$0.5V_{CC}$	GND to V_{CC}	6.0 ns	$0.5V_{CC}$
74HCT2G17	1.3 V	GND to 3.0 V	6.0 ns	1.3 V

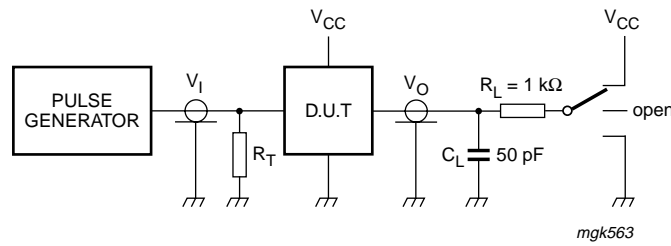

Test data is given in [Table 11](#).

Definitions test circuit:

R_L = Load resistance.

C_L = Load capacitance including jig and probe capacitance.

R_T = Termination resistance should be equal to output impedance Z_o of the pulse generator.

Fig 6. Load circuitry for switching times

Table 11. Test data

Type	Input		Test
	V_I	t_r, t_f	t_{PHL}, t_{PLH}
74HC2G17	GND to V_{CC}	6 ns	open
74HCT2G17	GND to 3.0 V	6 ns	open

14. Transfer characteristics

Table 12. Transfer characteristics

Voltages are referenced to GND (ground = 0 V); for test circuit see [Figure 6](#).

Symbol	Parameter	Conditions	25 °C			-40 °C to +125 °C			Unit
			Min	Typ	Max	Min	Max (85 °C)	Max (125 °C)	

74HC2G17

V_{T+}	positive-going threshold voltage	see Figure 7 , Figure 8							
		$V_{CC} = 2.0\text{ V}$	1.00	1.18	1.50	1.00	1.50	1.50	V
		$V_{CC} = 4.5\text{ V}$	2.30	2.60	3.15	2.30	3.15	3.15	V
V_{T-}	negative-going threshold voltage	see Figure 7 , Figure 8							
		$V_{CC} = 2.0\text{ V}$	0.30	0.60	0.90	0.30	0.90	0.90	V
		$V_{CC} = 4.5\text{ V}$	1.13	1.47	2.00	1.13	2.00	2.00	V
V_H	hysteresis voltage	$V_{T+} - V_{T-}$; see Figure 7 , Figure 8 and Figure 9							
		$V_{CC} = 2.0\text{ V}$	0.30	0.60	1.00	0.30	1.00	1.00	V
		$V_{CC} = 4.5\text{ V}$	0.60	1.13	1.40	0.60	1.40	1.40	V
		$V_{CC} = 6.0\text{ V}$	0.80	1.40	1.70	0.80	1.70	1.70	V

Table 12. Transfer characteristics ...continued

Voltages are referenced to GND (ground = 0 V); for test circuit see [Figure 6](#).

Symbol	Parameter	Conditions	25 °C			-40 °C to +125 °C			Unit
			Min	Typ	Max	Min	Max (85 °C)	Max (125 °C)	
74HCT2G17									
V_{T+}	positive-going threshold voltage	see Figure 7 and Figure 8							
		$V_{CC} = 4.5\text{ V}$	1.20	1.58	1.90	1.20	1.90	1.90	V
		$V_{CC} = 5.5\text{ V}$	1.40	1.78	2.10	1.40	2.10	2.10	V
V_{T-}	negative-going threshold voltage	see Figure 7 and Figure 8							
		$V_{CC} = 4.5\text{ V}$	0.50	0.87	1.20	0.50	1.20	1.20	V
		$V_{CC} = 5.5\text{ V}$	0.60	1.11	1.40	0.60	1.40	1.40	V
V_H	hysteresis voltage	$V_{T+} - V_{T-}$; see Figure 7 , Figure 8 and Figure 10							
		$V_{CC} = 4.5\text{ V}$	0.40	0.71	-	0.40	-	-	V
		$V_{CC} = 5.5\text{ V}$	0.40	0.67	-	0.40	-	-	V

15. Waveforms transfer characteristics

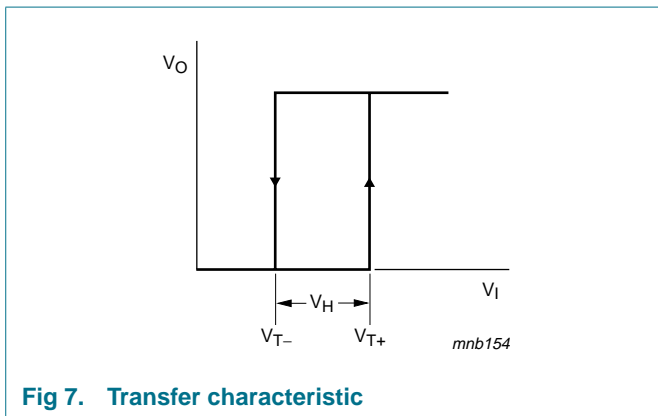

Fig 7. Transfer characteristic

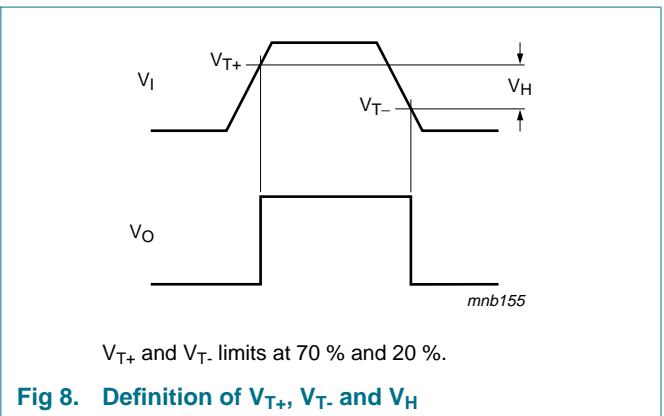
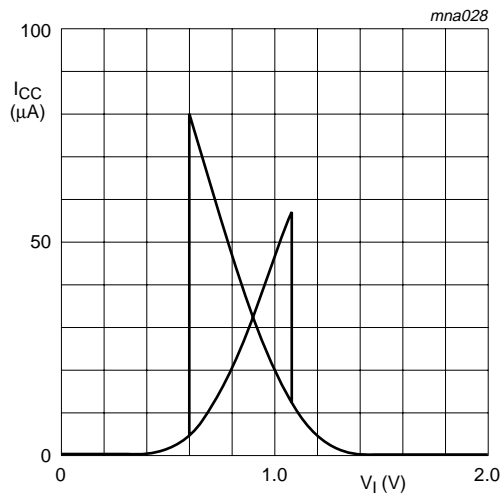
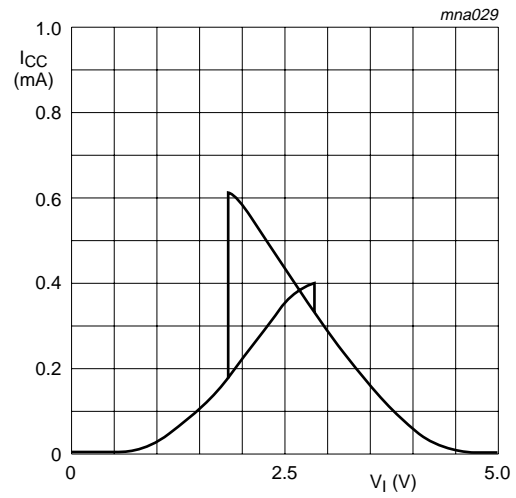

Fig 8. Definition of V_{T+} , V_{T-} and V_H



a. $V_{CC} = 2.0\text{ V}$



b. $V_{CC} = 4.5\text{ V}$

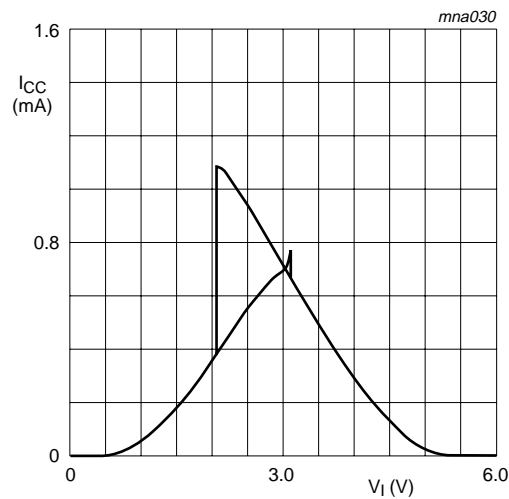

c. $V_{CC} = 6.0\text{ V}$

Fig 9. Typical 74HC2G17 transfer characteristics

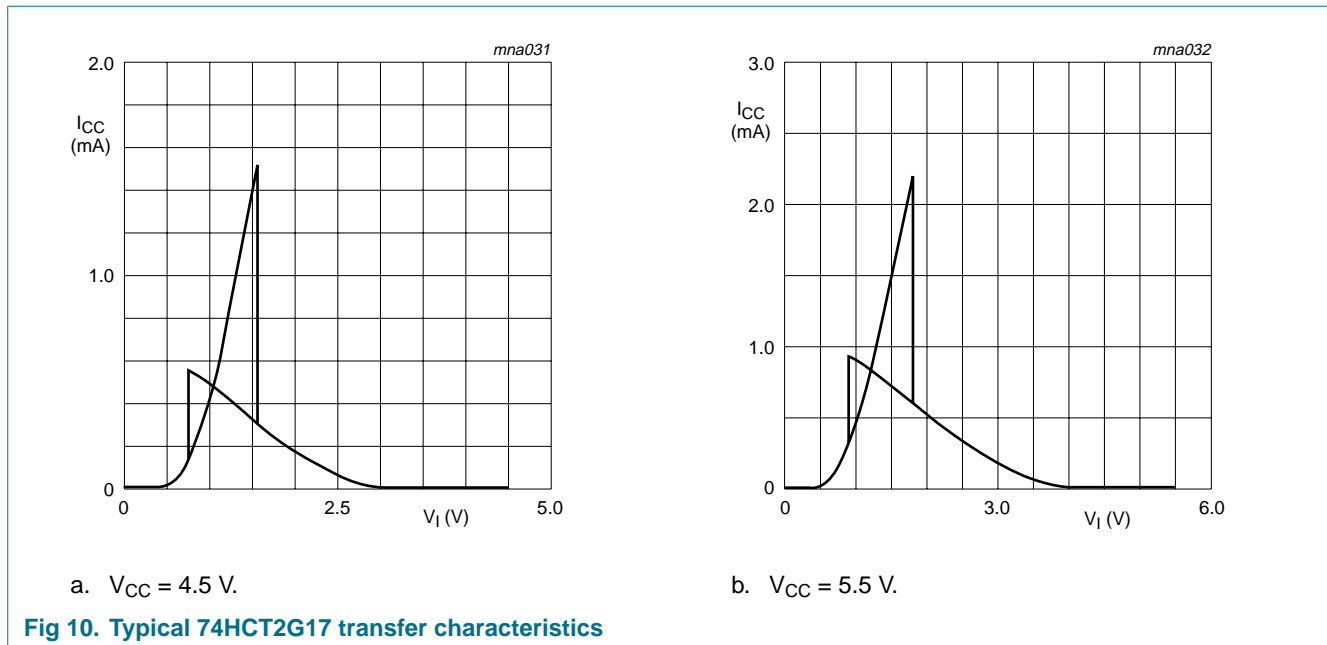

16. Application information

The slow input rise and fall times cause additional power dissipation, this can be calculated using the following formula:

$$P_{\text{add}} = f_i \times (t_r \times \Delta I_{CC(\text{AV})} + t_f \times \Delta I_{CC(\text{AV})}) \times V_{CC} \text{ where:}$$

P_{add} = additional power dissipation (μW);

f_i = input frequency (MHz);

t_r = input rise time (ns); 10 % to 90 %;

t_f = input fall time (ns); 90 % to 10 %;

$\Delta I_{CC(\text{AV})}$ = average additional supply current (μA).

$\Delta I_{CC(\text{AV})}$ differs with positive or negative input transitions, as shown in [Figure 11](#) and [Figure 12](#).

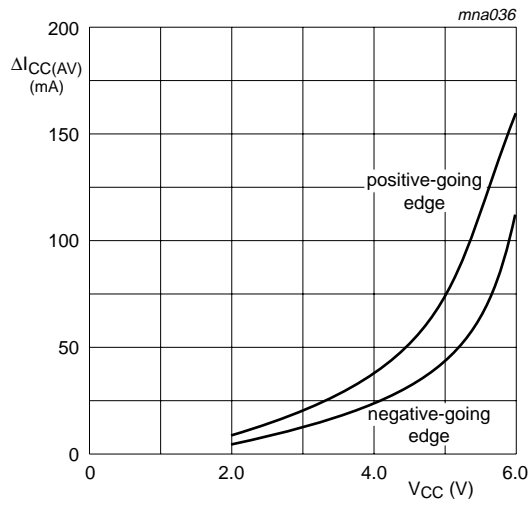

Fig 11. $\Delta I_{CC(AV)}$ as a function of V_{CC} for 74HC2G17; linear change of V_I between $0.1V_{CC}$ to $0.9V_{CC}$

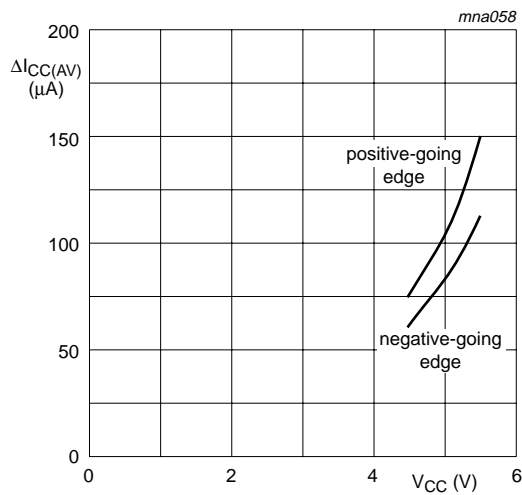

Fig 12. $\Delta I_{CC(AV)}$ as a function of V_{CC} for 74HCT2G17; linear change of V_I between $0.1V_{CC}$ to $0.9V_{CC}$

17. Package outline

Plastic surface-mounted package; 6 leads

SOT363

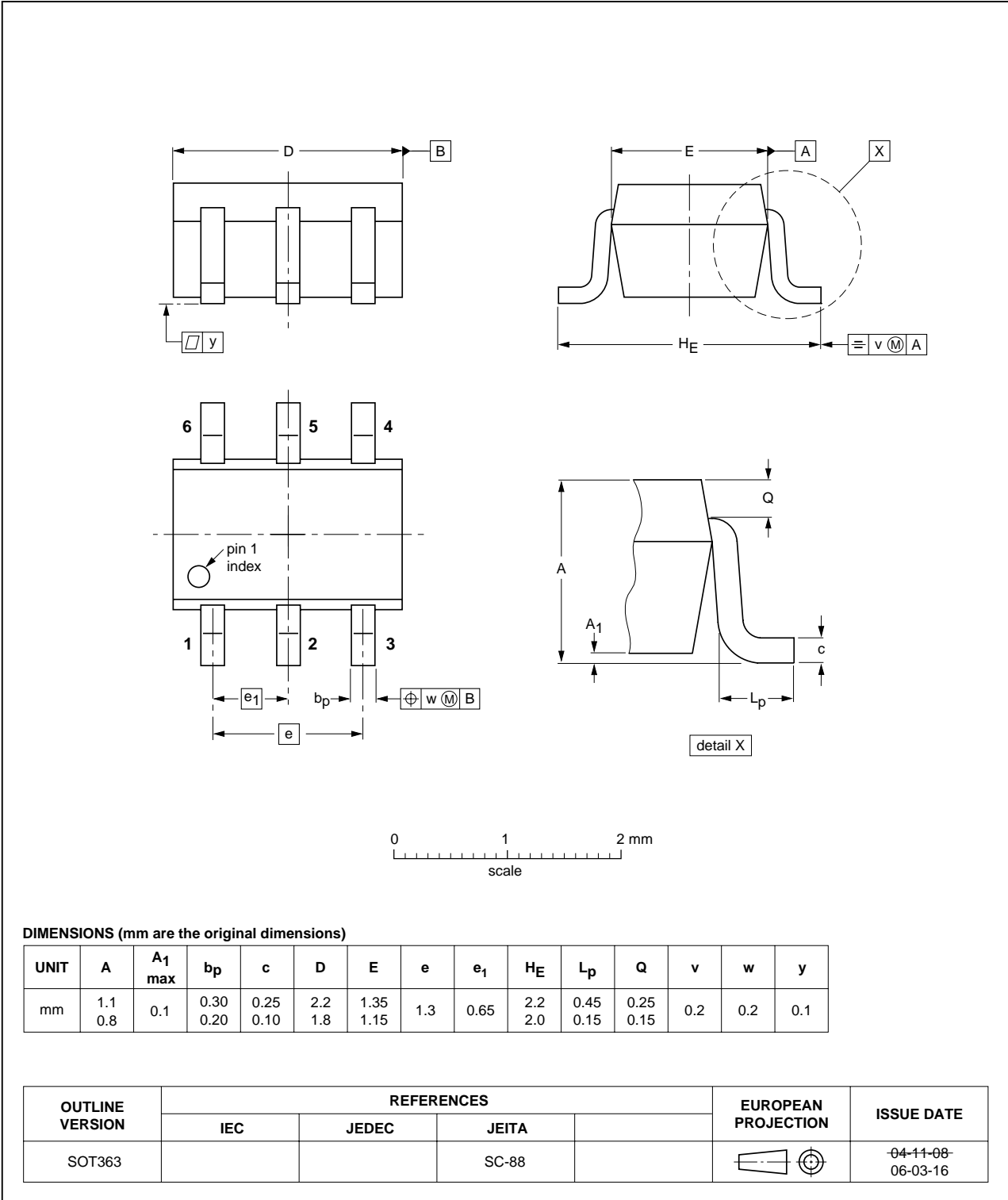

Fig 13. Package outline SOT363 (SC-88)

Plastic surface-mounted package (TSOP6); 6 leads

SOT457

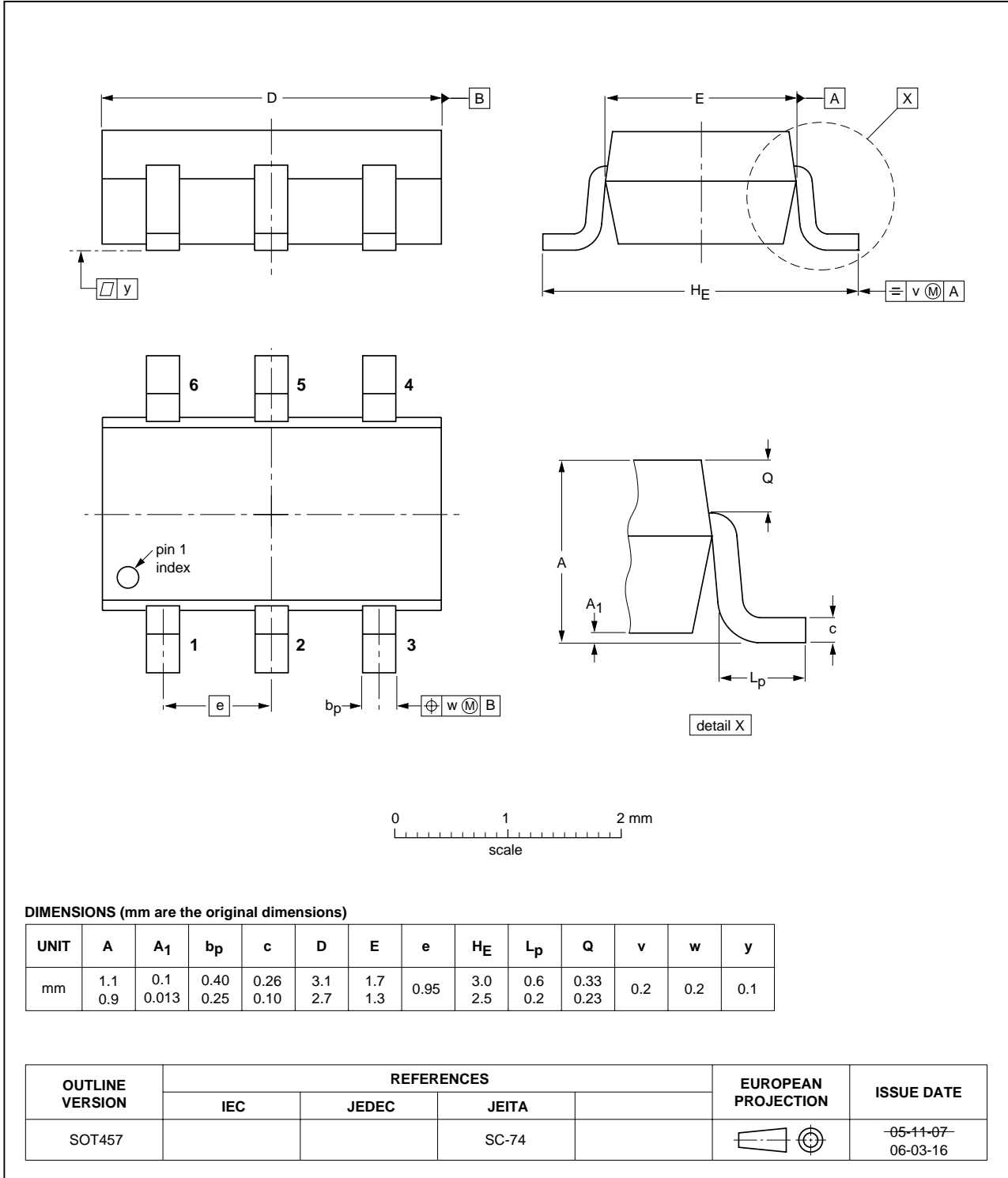

Fig 14. Package outline SOT457 (SC-74)

18. Abbreviations

Table 13. Abbreviations

Acronym	Description
CMOS	Complementary Metal Oxide Semiconductor
ESD	ElectroStatic Discharge
HBM	Human Body Model
MM	Machine Model
DUT	Device Under Test

19. Revision history

Table 14. Revision history

Document ID	Release date	Data sheet status	Change notice	Supersedes
74HC_HCT2G17_1	20061006	Product data sheet	-	-

20. Legal information

20.1 Data sheet status

Document status ^{[1][2]}	Product status ^[3]	Definition
Objective [short] data sheet	Development	This document contains data from the objective specification for product development.
Preliminary [short] data sheet	Qualification	This document contains data from the preliminary specification.
Product [short] data sheet	Production	This document contains the product specification.

[1] Please consult the most recently issued document before initiating or completing a design.

[2] The term 'short data sheet' is explained in section "Definitions".

[3] The product status of device(s) described in this document may have changed since this document was published and may differ in case of multiple devices. The latest product status information is available on the Internet at URL <http://www.nexperia.com>.

20.2 Definitions

Draft — The document is a draft version only. The content is still under internal review and subject to formal approval, which may result in modifications or additions. Nexperia does not give any representations or warranties as to the accuracy or completeness of information included herein and shall have no liability for the consequences of use of such information.

Short data sheet — A short data sheet is an extract from a full data sheet with the same product type number(s) and title. A short data sheet is intended for quick reference only and should not be relied upon to contain detailed and full information. For detailed and full information see the relevant full data sheet, which is available on request via the local Nexperia sales office. In case of any inconsistency or conflict with the short data sheet, the full data sheet shall prevail.

20.3 Disclaimers

General — Information in this document is believed to be accurate and reliable. However, Nexperia does not give any representations or warranties, expressed or implied, as to the accuracy or completeness of such information and shall have no liability for the consequences of use of such information.

Right to make changes — Nexperia reserves the right to make changes to information published in this document, including without limitation specifications and product descriptions, at any time and without notice. This document supersedes and replaces all information supplied prior to the publication hereof.

Suitability for use — Nexperia products are not designed, authorized or warranted to be suitable for use in medical, military, aircraft, space or life support equipment, nor in applications where failure or

malfunction of a Nexperia product can reasonably be expected to result in personal injury, death or severe property or environmental damage. Nexperia accepts no liability for inclusion and/or use of Nexperia products in such equipment or applications and therefore such inclusion and/or use is at the customer's own risk.

Applications — Applications that are described herein for any of these products are for illustrative purposes only. Nexperia makes no representation or warranty that such applications will be suitable for the specified use without further testing or modification.

Limiting values — Stress above one or more limiting values (as defined in the Absolute Maximum Ratings System of IEC 60134) may cause permanent damage to the device. Limiting values are stress ratings only and operation of the device at these or any other conditions above those given in the Characteristics sections of this document is not implied. Exposure to limiting values for extended periods may affect device reliability.

Terms and conditions of sale — Nexperia products are sold subject to the general terms and conditions of commercial sale, as published at <http://www.nexperia.com/profile/terms>, including those pertaining to warranty, intellectual property rights infringement and limitation of liability, unless explicitly otherwise agreed to in writing by Nexperia. In case of any inconsistency or conflict between information in this document and such terms and conditions, the latter will prevail.

No offer to sell or license — Nothing in this document may be interpreted or construed as an offer to sell products that is open for acceptance or the grant, conveyance or implication of any license under any copyrights, patents or other industrial or intellectual property rights.

20.4 Trademarks

Notice: All referenced brands, product names, service names and trademarks are the property of their respective owners.

21. Contact information

For additional information, please visit: <http://www.nexperia.com>

For sales office addresses, send an email to: salesaddresses@nexperia.com

22. Contents

1	General description	1
2	Features	1
3	Applications	1
4	Ordering information	2
5	Marking	2
6	Functional diagram	2
7	Pinning information	3
7.1	Pinning	3
7.2	Pin description	3
8	Functional description	3
9	Limiting values	4
10	Recommended operating conditions	4
11	Static characteristics	4
12	Dynamic characteristics	7
13	Waveforms	8
14	Transfer characteristics	9
15	Waveforms transfer characteristics	10
16	Application information	12
17	Package outline	14
18	Abbreviations	16
19	Revision history	16
20	Legal information	17
20.1	Data sheet status	17
20.2	Definitions	17
20.3	Disclaimers	17
20.4	Trademarks	17
21	Contact information	17
22	Contents	18