

Accutek Microcircuit Corporation

Standard Pitch DIP Adapters

STANDARD 0.050" PITCH IC COMPONENT DIP ADAPTER MODULES ELIMINATE THE NEED TO REDESIGN MOTHERBOARDS OR MAY BE USED FOR BREADBOARD PROTOTYPING



DESCRIPTION

This new family of Accutek DIP Adapter Modules convert surface mount SOJ, PLCC and SOIC IC's to pin compatible DIP packages for creating drop-in replacements for end-of-life DIP IC's.

These DIP Adapters were developed for users with motherboard designs that require DIP's, now obsoleted by manufacturers. These adapter modules save costly motherboard redesigns.

Available with machined or flat contact pins. Accutek DIP Adapter Modules feature 4 to 32 pins, are fully assembled and tested and may include a decoupling capacitor. These DIP Adapters can be manufactured turnkey or from customer supplied surface mount chips. Modules range in length from 0.200" to 2.000" depending on number of pins and incorporate 0.300", 0.400" and 0.600" row-to-row spacing with 0.100" lead spacing.

Custom configurations up to 200 pins, multi-chip and double sided modules are also available for special functions. A variety of pin lengths with varying diameters as well as custom sizes and spacing can be specified with different materials and finishes. All modules are designed in-house using PCB CAD workstations. Assembly and 100% testing are also performed in-house.

FEATURES

- Saves costly redesign of current motherboards
- Fully tested with lifetime limited warranty
- May include an on board decoupling capacitor
- IC assembly and testing available
- EPROM and Flash programming available
- Custom lead lengths available
- Custom multi-chip and double-sided modules available

ORDERING OPTIONS

- Adapter only
- Customer supplies chips - Accutek assembles on Accutek adapters, tests and delivers finished product in antistatic tubes.
- Complete turnkey - Accutek purchases IC's and passives. Then assembles, tests and delivers finished product in antistatic tubes.



ACCUTEK MICROCIRCUIT CORPORATION

BUSINESS CENTER at NEWBURYPORT
2 NEW PASTURE ROAD, SUITE 1
NEWBURYPORT, MA 01950-4054

PHONE: 978-465-6200 FAX: 978-462-3396
E-Mail: sales@accutekmicro.com
Internet: www.accutekmicro.com

AK08D-NSO

8 PIN SOIC TO DIP

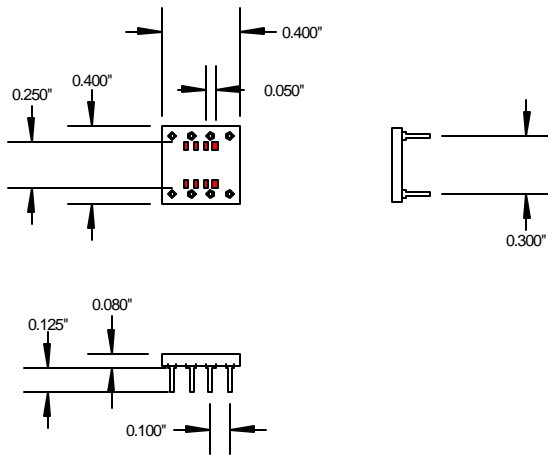

AK14D-NSO

14 PIN SOIC TO DIP

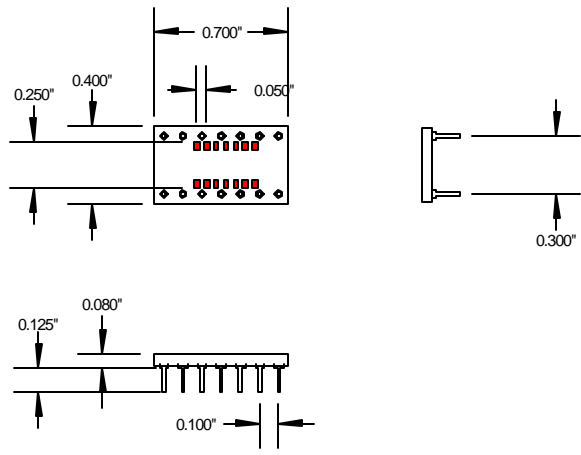

AK16D-NSO

16 PIN SOIC TO DIP

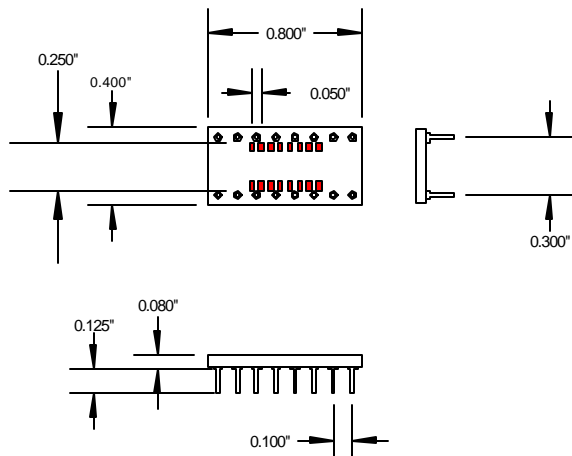

AK16D-WSO

16 PIN WIDE SOIC TO DIP

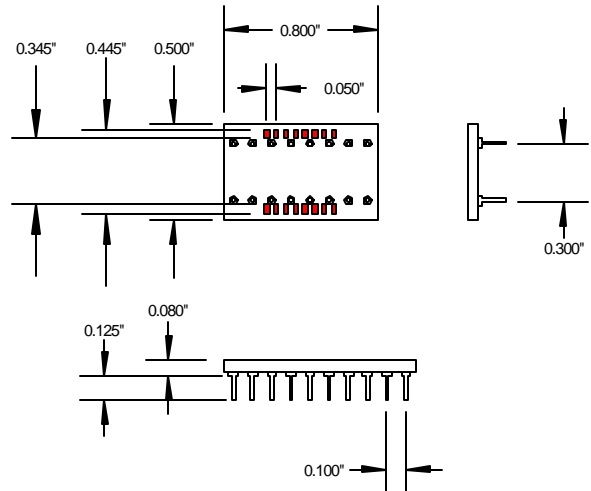

AK18D-NSO

18 PIN NARROW SOIC TO DIP

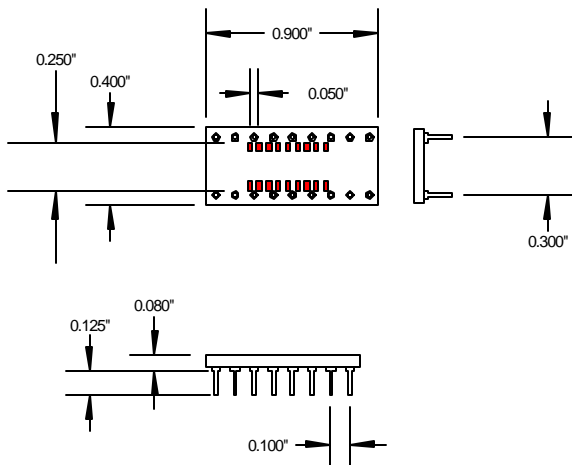

AK18D-NWSO

18 PIN WIDE OR NARROW SOIC TO DIP

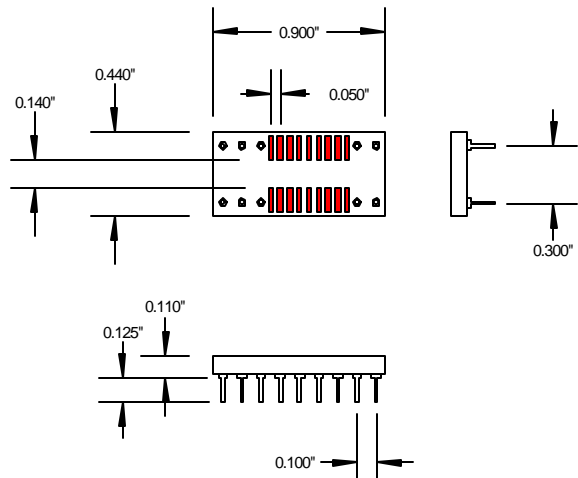

AK20D-NWSO

20 PIN NARROW OR WIDE SOIC TO DIP

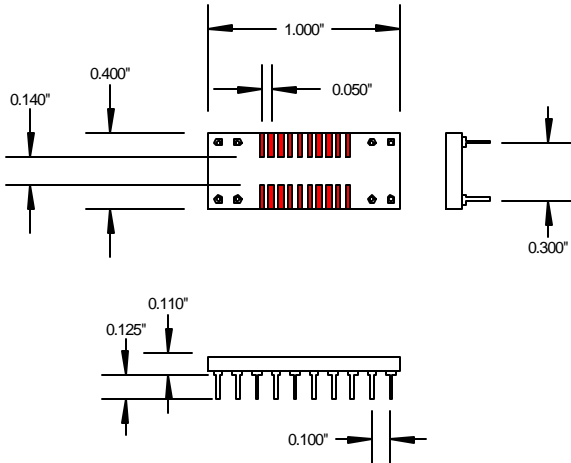

AK20D-PLCC

20 PIN PLCC TO DIP

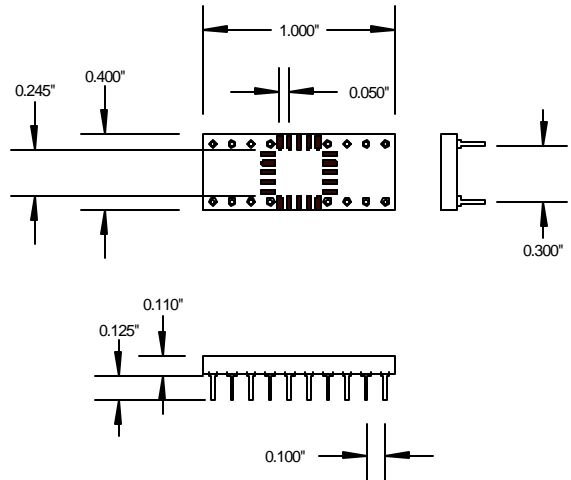

AK20DS-PLCC

(with PLCC Socket included)

20 PIN PLCC SOCKET TO DIP

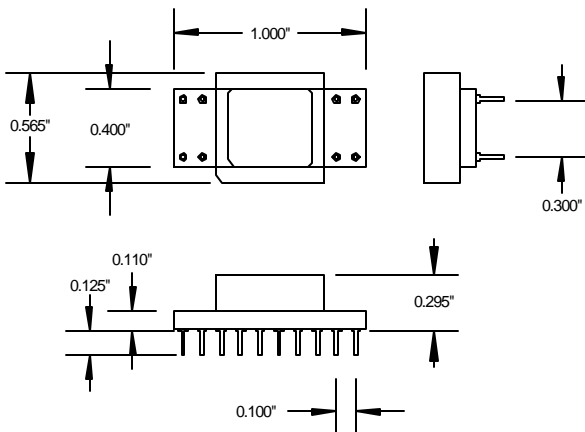

AK20D-WSO

20 PIN WIDE SOIC TO DIP

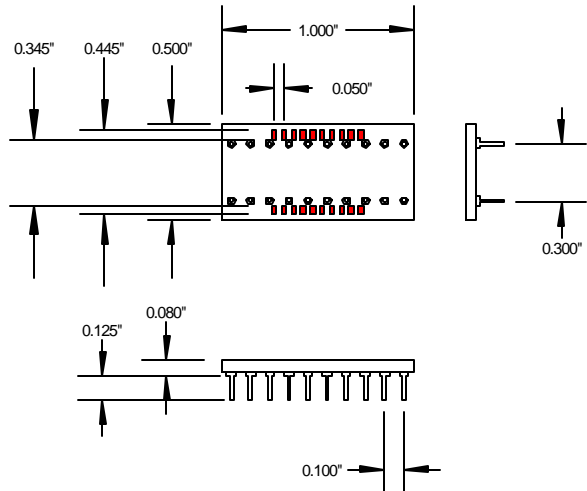

AK24D-SOIC

24 PIN SOIC TO DIP

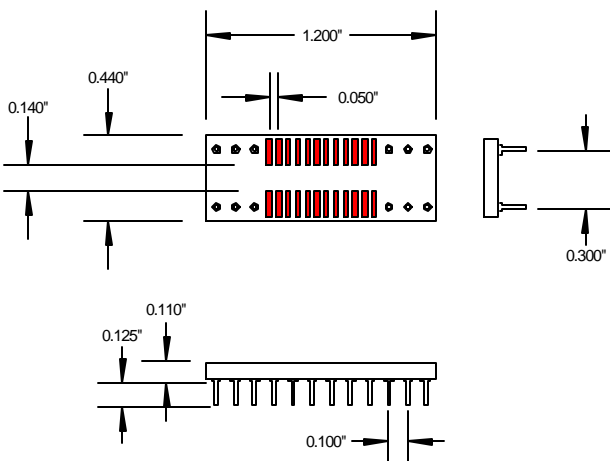

AK24D-SOJ

24 PIN SOJ TO DIP

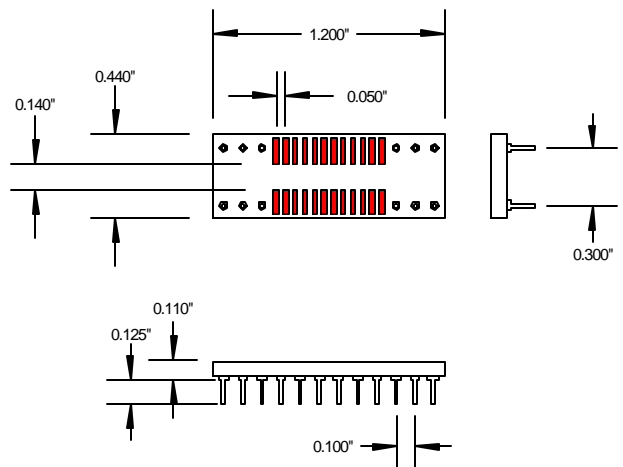

AK28D300-SOJ

28 PIN SOJ TO .300" DIP

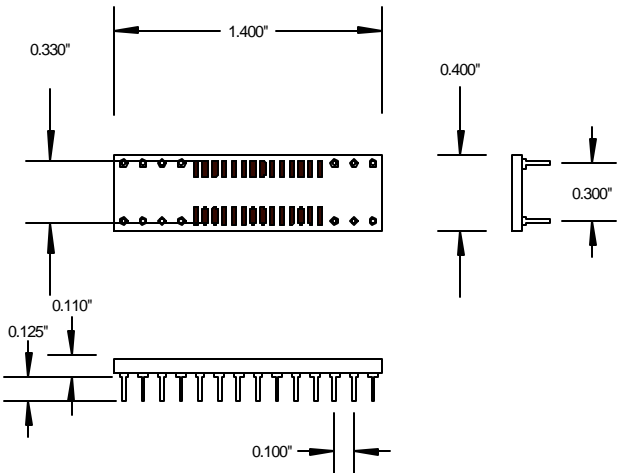

AK28D-SOIC

28 PIN SOIC TO DIP

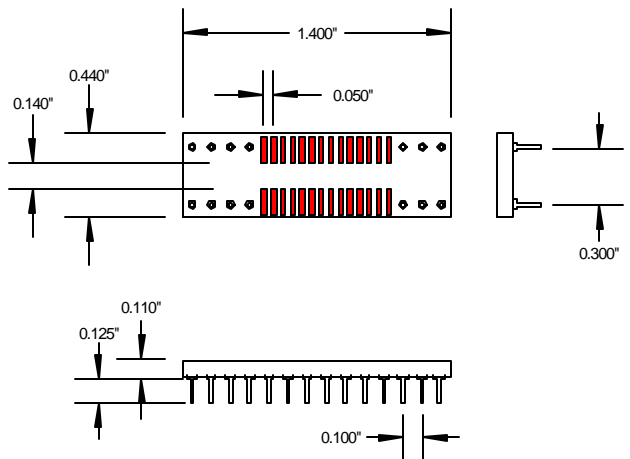

AK32D300-SOJ

32 PIN SOJ TO .300" DIP

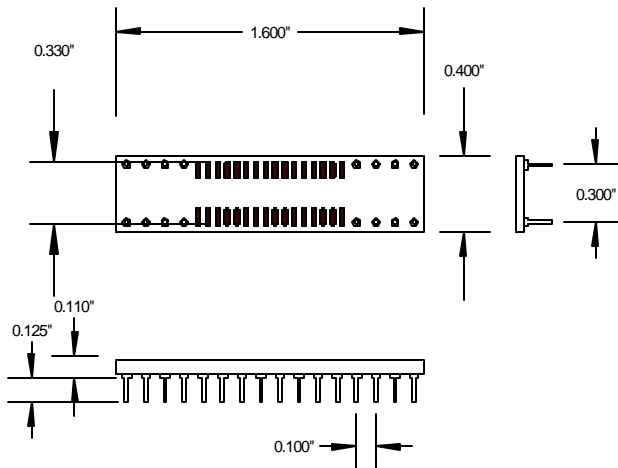

AK32D400-SOJ

32 PIN SOJ TO .400" DIP

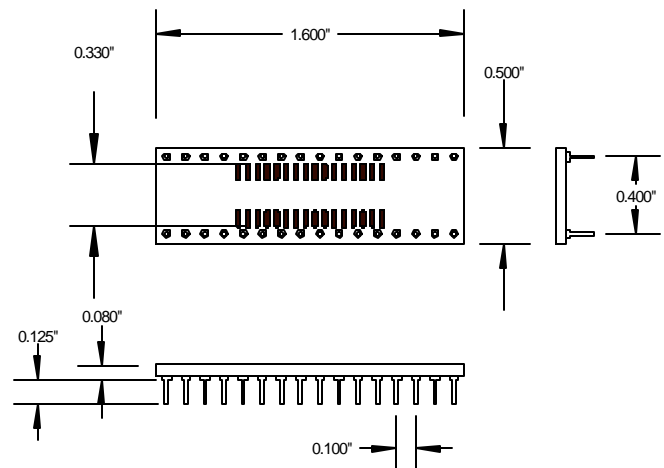

AK32DS-PLCC

(with PLCC Socket included)

32 PIN SOJ SOCKET TO DIP

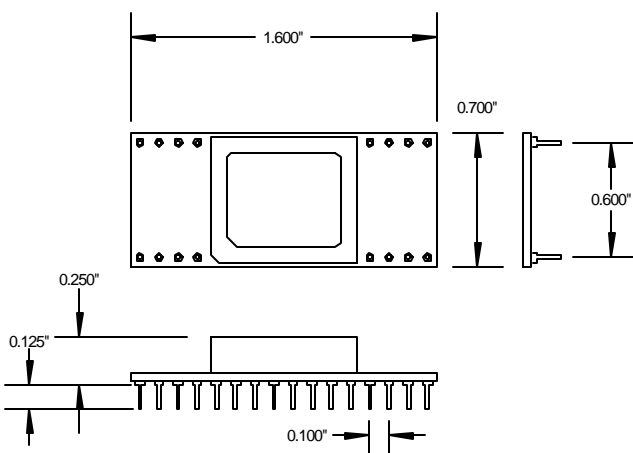

AK32DW-PLCC

32 PIN PLCC TO DIP (MACHINED PINS)

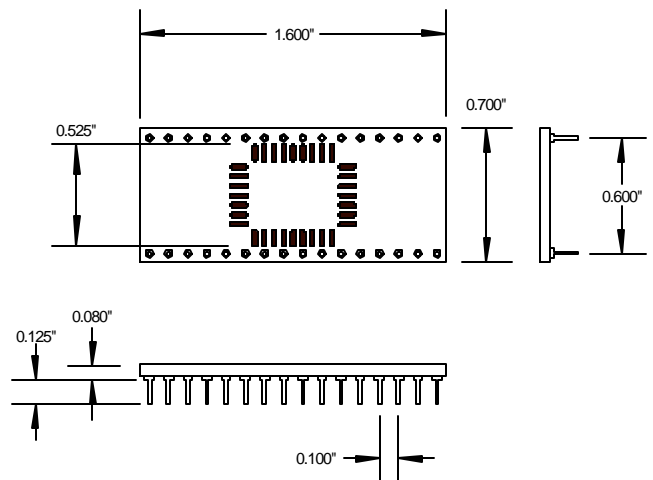

AK18D-SOJ-64KX4
(for 64K X 4 DRAMs)

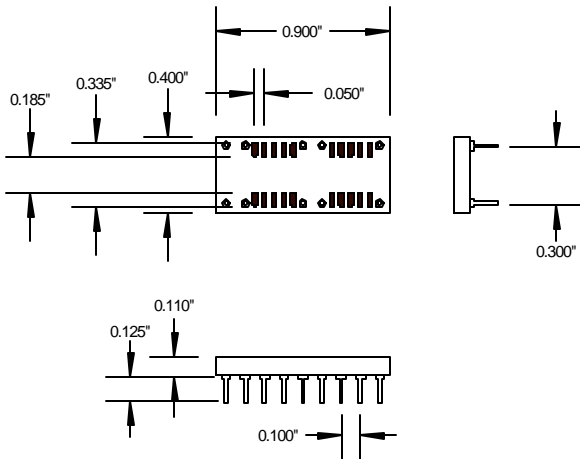

AK20D-PLCC
(can be used for programmable devices)

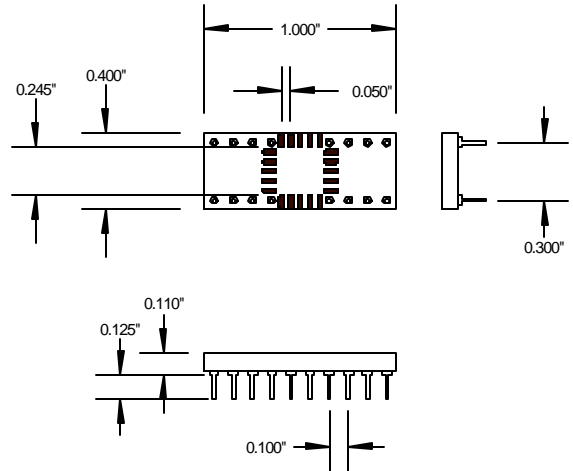

AK20D-SOJ
(for 1Meg & 4 Meg DRAMs)

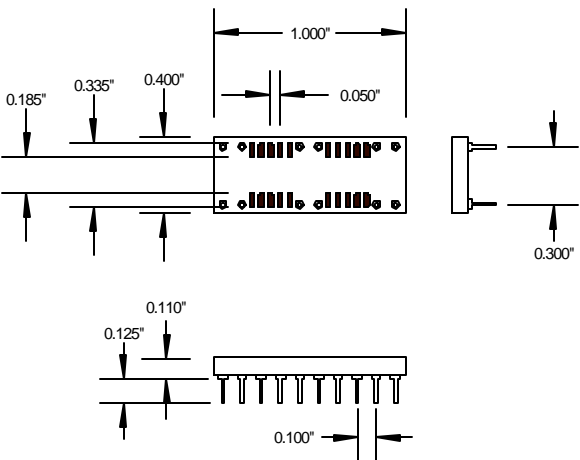

AK28D300-SRAM (for 32K x 8,
64K x 4 & 256K x 4 Static RAM)

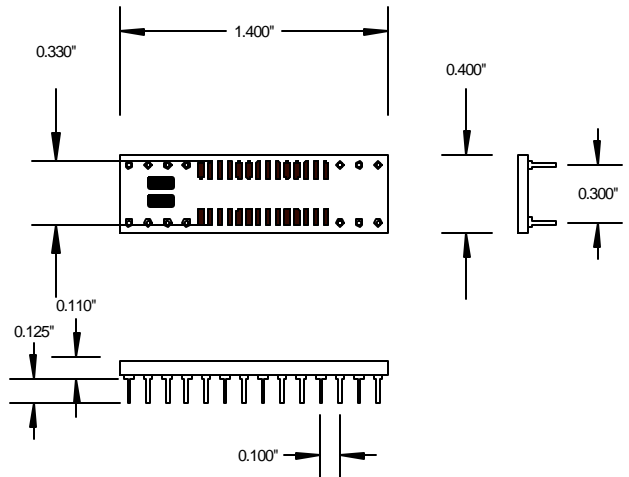

AK32D300-SRAM
(for 128K x 8 Static RAM)

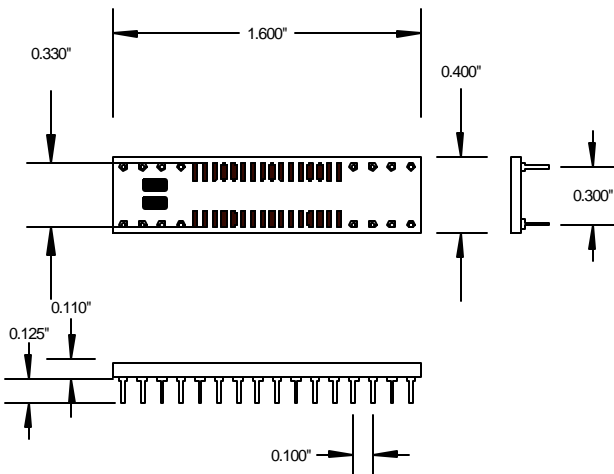

AK32D400-SRAM
(for 128K x 8 Static RAM)

