

2MBI100SC-120

IGBT Module

1200V / 100A 2 in one-package

■ Features

- High speed switching
- Voltage drive
- Low inductance module structure

■ Applications

- Inverter for Motor drive
- AC and DC Servo drive amplifier
- Uninterruptible power supply
- Industrial machines, such as Welding machines

■ Maximum ratings and characteristics

● Absolute maximum ratings (at Tc=25°C unless otherwise specified)

Item	Symbol	Rating	Unit		
Collector-Emitter voltage	V _{CEs}	1200	V		
Gate-Emitter voltage	V _{GES}	±20	V		
Collector current	Continuous	T _c =25°C	I _C	150	A
		T _c =80°C		100	A
	1ms	T _c =25°C	I _C pulse	300	A
		T _c =80°C		200	A
	1ms		-I _C	100	A
		-I _C pulse	200	A	
Max. power dissipation	P _C	780	W		
Operating temperature	T _j	+150	°C		
Storage temperature	T _{stg}	-40 to +125	°C		
Isolation voltage *1	V _{is}	AC 2500 (1min.)	V		
Screw torque	Mounting *2	3.5	N·m		
	Terminals *2	3.5	N·m		

*1 : All terminals should be connected together when isolation test will be done

*2 : Recommendable value : 2.5 to 3.5 N·m(M5)

● Electrical characteristics (at T_j=25°C unless otherwise specified)

Item	Symbol	Characteristics			Conditions	Unit	
		Min.	Typ.	Max.			
Zero gate voltage collector current	I _{CEs}	–	–	2.0	V _{GE} =0V, V _{CE} =1200V	mA	
Gate-Emitter leakage current	I _{GES}	–	–	0.4	V _{CE} =0V, V _{GE} =±20V	μA	
Gate-Emitter threshold voltage	V _{GE(th)}	5.5	7.2	8.5	V _{CE} =20V, I _C =100mA	V	
Collector-Emitter saturation voltage	V _{CE(sat)}	–	2.3	2.6	T _c =25°C	V _{GE} =15V, I _C =100A	V
		–	2.8	–	T _c =125°C		
Input capacitance	C _{ies}	–	12000	–	V _{GE} =0V	pF	
Output capacitance	C _{oes}	–	2500	–	V _{CE} =10V		
Reverse transfer capacitance	C _{res}	–	2200	–	f=1MHz		
Turn-on time	t _{on}	–	0.35	1.2	V _{CC} =600V	μs	
	t _r	–	0.25	0.6	I _C =100A		
	t _{r(i)}	–	0.1	–	V _{GE} =±15V		
Turn-off time	t _{off}	–	0.45	1.0	R _G =9.1 ohm	μs	
	t _f	–	0.08	0.3			
Forward on voltage	V _F	–	2.3	3.0	T _j =25°C	I _F =100A, V _{GE} =0V	V
		–	2.0	–	T _j =125°C		
Reverse recovery time	t _{rr}	–	–	0.35	I _F =100A	μs	

● Thermal resistance characteristics

Item	Symbol	Characteristics			Conditions	Unit
		Min.	Typ.	Max.		
Thermal resistance	R _{th(j-c)}	–	–	0.16	IGBT	°C/W
	R _{th(j-c)}	–	–	0.33	Diode	°C/W
	R _{th(c-f)*2}	–	0.05	–	the base to cooling fin	°C/W

*2 : This is the value which is defined mounting on the additional cooling fin with thermal compound



Equivalent Circuit Schematic

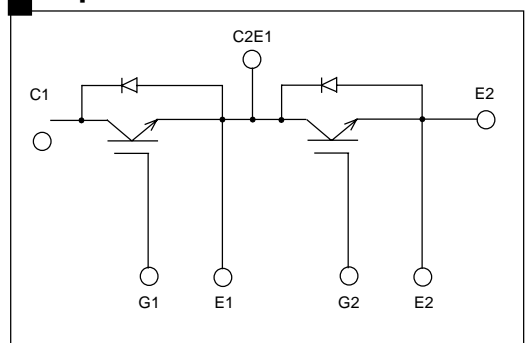

Characteristics (Representative)

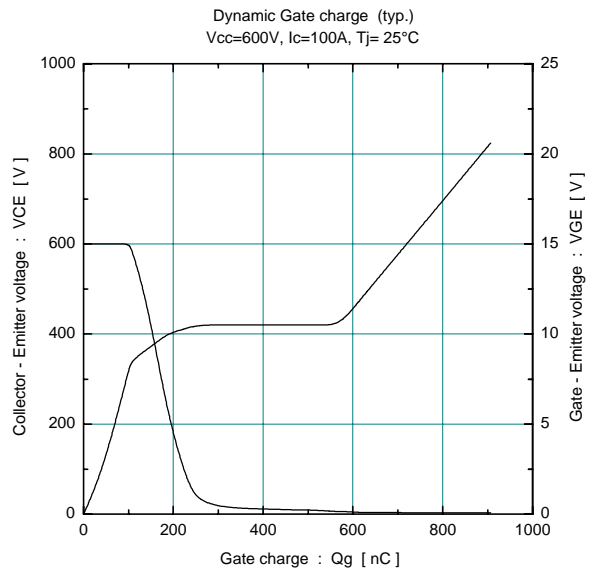
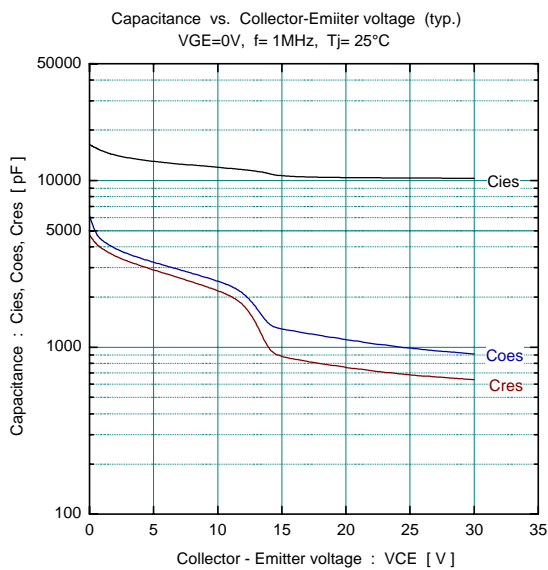
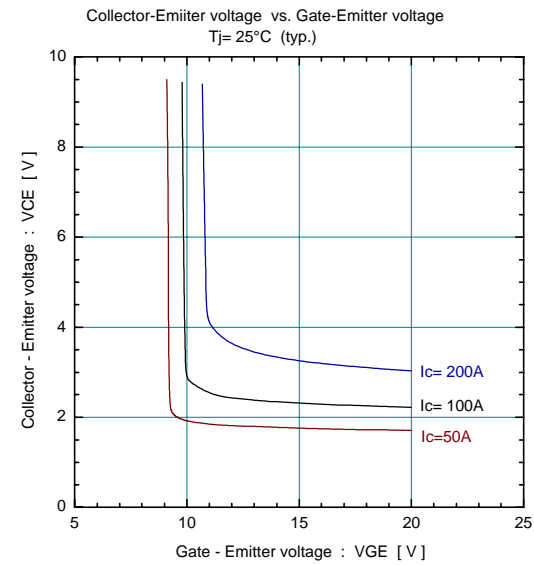
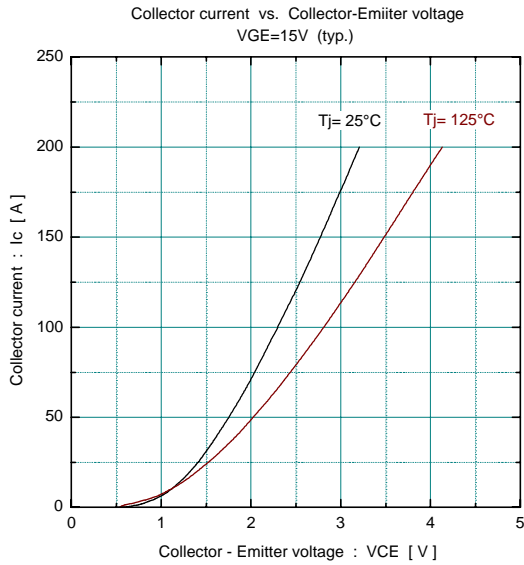
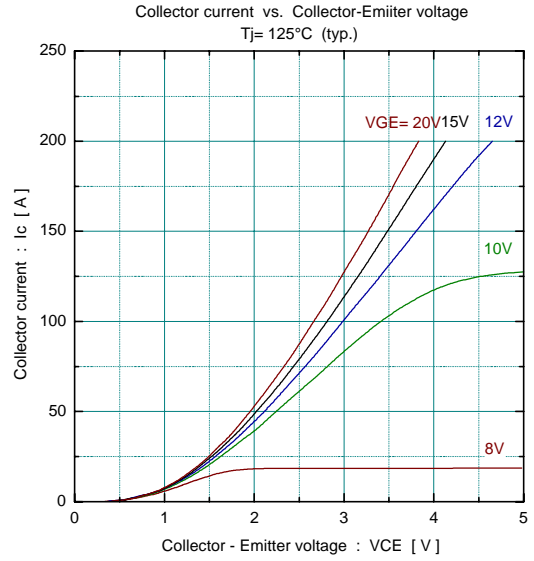
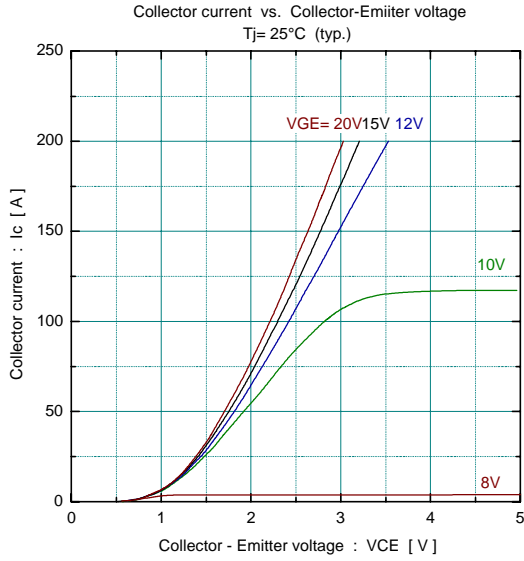

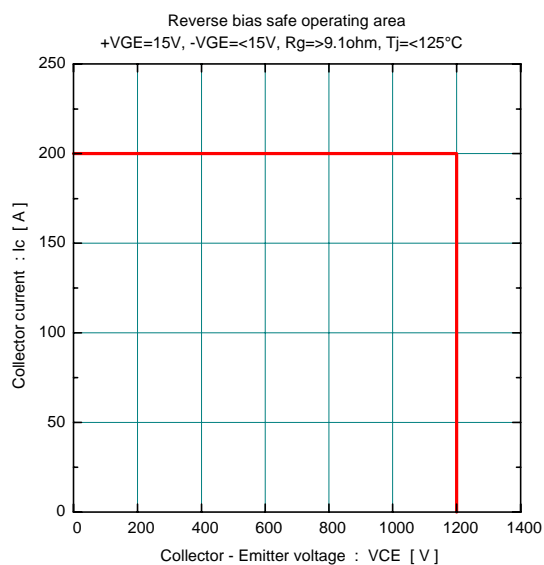
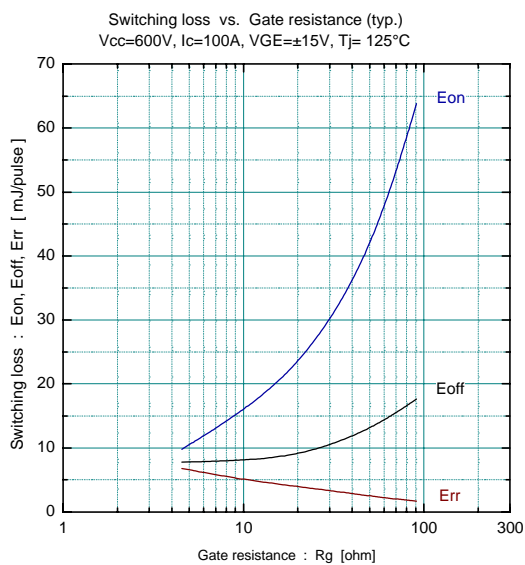
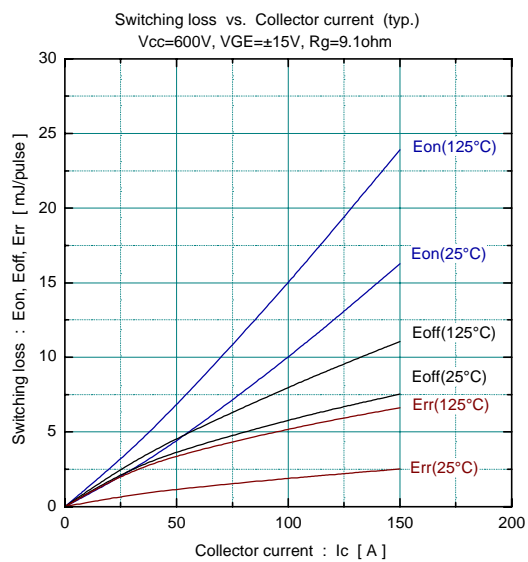
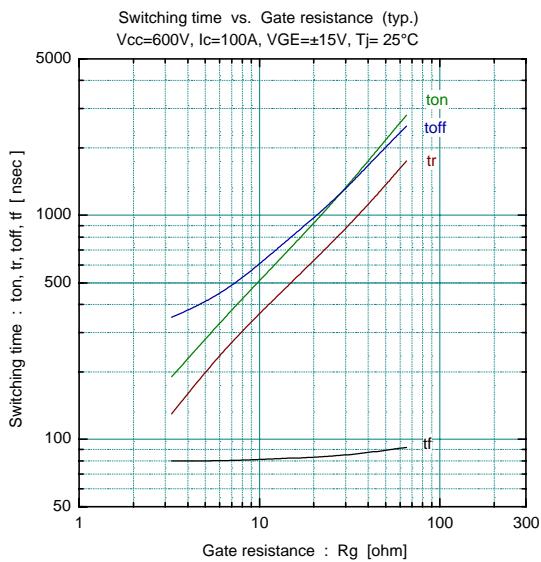
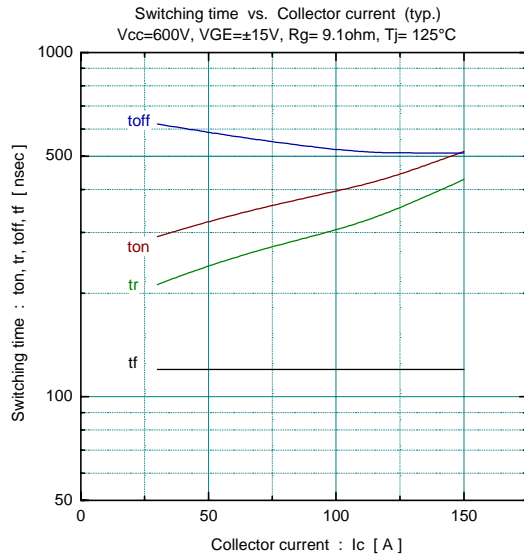
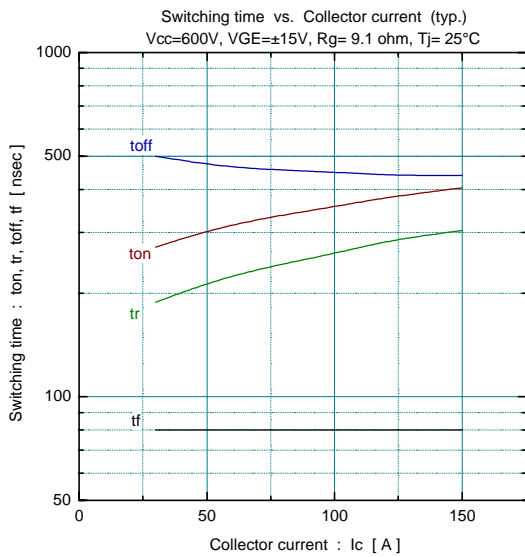

Forward current vs. Forward on voltage (typ.)

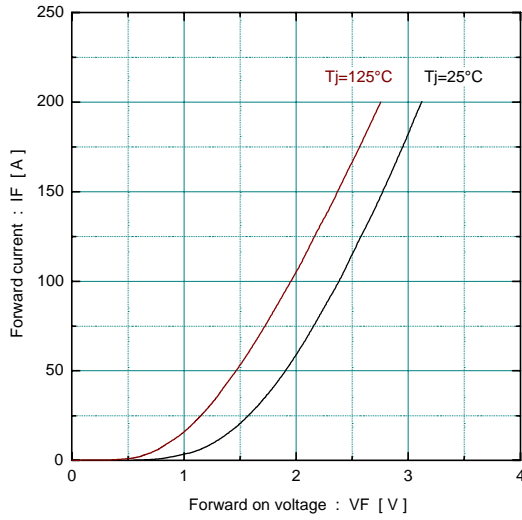

Reverse recovery characteristics (typ.)
Vcc=600V, VGE=±15V, Rg=9.1ohm

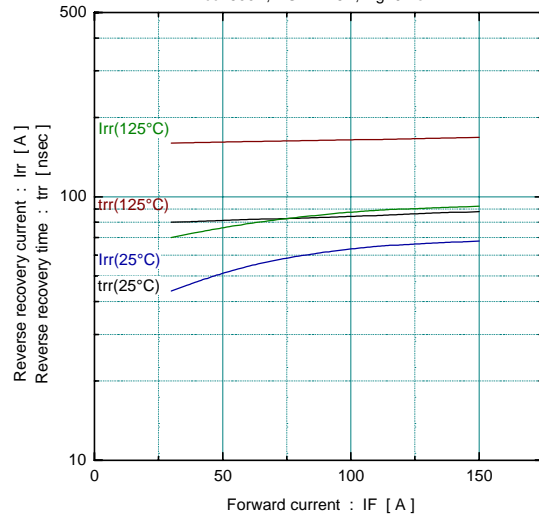

Transient thermal resistance

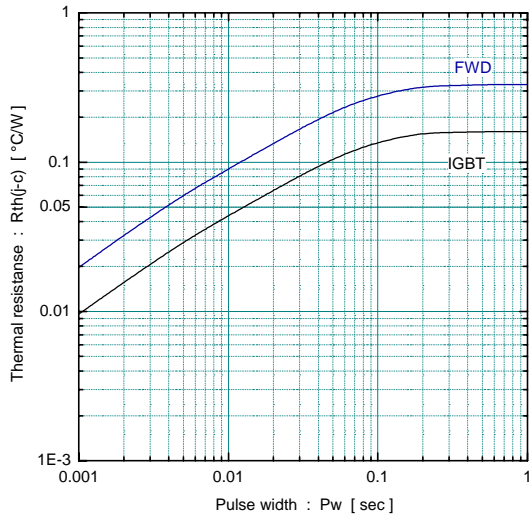

■ Outline Drawings, mm

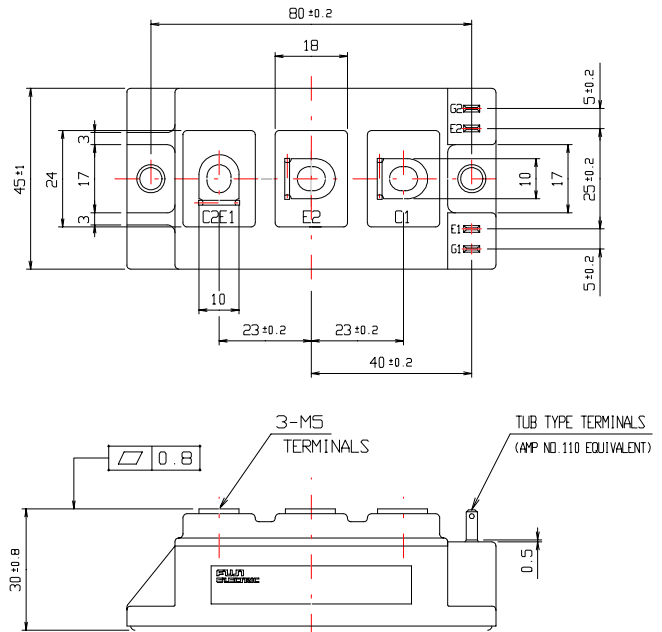

mass : 240g