

# NTMSD6N303, NVMSD6N303

## Power MOSFET

### 6 Amps, 30 Volts N-Channel SO-8 FETKY™

The FETKY product family incorporates low  $R_{DS(on)}$  MOSFETs packaged with an industry leading, low forward drop, low leakage Schottky Barrier rectifier to offer high efficiency components in a space saving configuration. Independent pinouts for MOSFET and Schottky die allow the flexibility to use a single component for switching and rectification functions in a wide variety of applications.

#### Features

- These Devices are Pb-Free and are RoHS Compliant
- NVMSD Prefix for Automotive and Other Applications Requiring Unique Site and Control Change Requirements; AEC-Q101 Qualified and PPAP Capable

#### Applications

- Buck Converter
- Buck-Boost
- Synchronous Rectification
- Low Voltage Motor Control
- Battery Packs
- Chargers
- Cell Phones

#### MOSFET MAXIMUM RATINGS

( $T_J = 25^\circ\text{C}$  unless otherwise noted) (Note 1)

Rating	Symbol	Value	Unit
Drain-to-Source Voltage	$V_{DS}$	30	Vdc
Drain-to-Gate Voltage ( $R_{GS} = 1.0\text{ M}\Omega$ )	$V_{DGR}$	30	Vdc
Gate-to-Source Voltage - Continuous	$V_{GS}$	$\pm 20$	Vdc
Drain Current - (Note 2)			
- Continuous @ $T_A = 25^\circ\text{C}$	$I_D$	6.0	Adc
- Single Pulse ( $t_p \leq 10\ \mu\text{s}$ )	$I_{DM}$	30	Apk
Total Power Dissipation @ $T_A = 25^\circ\text{C}$ (Note 2)	$P_D$	2.0	Watts
Single Pulse Drain-to-Source Avalanche Energy - Starting $T_J = 25^\circ\text{C}$ ( $V_{DD} = 30\text{ Vdc}$ , $V_{GS} = 5.0\text{ Vdc}$ , $V_{DS} = 20\text{ Vdc}$ , $I_L = 9.0\text{ Apk}$ , $L = 10\text{ mH}$ , $R_G = 25\ \Omega$ )	$E_{AS}$	325	mJ

Stresses exceeding Maximum Ratings may damage the device. Maximum Ratings are stress ratings only. Functional operation above the Recommended Operating Conditions is not implied. Extended exposure to stresses above the Recommended Operating Conditions may affect device reliability.

1. Pulse Test: Pulse Width  $\leq 250\ \mu\text{s}$ , Duty Cycle  $\leq 2.0\%$ .
2. Mounted on 2" square FR4 board  
(1 in sq, 2 oz. Cu 0.06" thick single sided), 10 sec. max.



ON Semiconductor®

<http://onsemi.com>

**MOSFET**  
**6.0 AMPERES**  
**30 VOLTS**  
**24 m $\Omega$  @  $V_{GS} = 10\text{ V}$  (Typ)**

**SCHOTTKY DIODE**  
**6.0 AMPERES**  
**30 VOLTS**  
**420 mV @  $I_F = 3.0\text{ A}$**

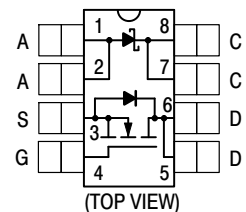

#### MARKING DIAGRAM & PIN ASSIGNMENT



SO-8  
CASE 751  
STYLE 18

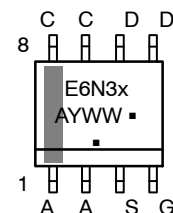

E6N3 = Device Code  
x = Blank or S  
A = Assembly Location  
Y = Year  
WW = Work Week  
▪ = Pb-Free Package  
(Note: Microdot may be in either location)

#### ORDERING INFORMATION

Device	Package	Shipping†
NTMSD6N303R2G	SO-8 (Pb-Free)	2500/Tape & Reel
NTMSD6N303R2SG	SO-8 (Pb-Free)	2500/Tape & Reel
NVMSD6N303R2G	SO-8 (Pb-Free)	2500/Tape & Reel

†For information on tape and reel specifications, including part orientation and tape sizes, please refer to our Tape and Reel Packaging Specification Brochure, BRD8011/D.

## NTMSD6N303, NVMSD6N303

### SCHOTTKY RECTIFIER MAXIMUM RATINGS ( $T_J = 25^\circ\text{C}$ unless otherwise noted)

Rating	Symbol	Value	Unit
Peak Repetitive Reverse Voltage DC Blocking Voltage	$V_{RRM}$ $V_R$	30	Volts
Average Forward Current (Note 3) (Rated $V_R$ ) $T_A = 104^\circ\text{C}$	$I_O$	2.0	Amps
Peak Repetitive Forward Current (Note 3) (Rated $V_R$ , Square Wave, 20 kHz) $T_A = 108^\circ\text{C}$	$I_{frm}$	4.0	Amps
Non-Repetitive Peak Surge Current (Surge applied at rated load conditions, half-wave, single phase, 60 Hz)	$I_{fsm}$	30	Amps

### THERMAL CHARACTERISTICS – SCHOTTKY AND MOSFET

Thermal Resistance – Junction-to-Ambient (Note 4) – MOSFET	$R_{\theta JA}$	167	°C/W
Thermal Resistance – Junction-to-Ambient (Note 5) – MOSFET	$R_{\theta JA}$	97	
Thermal Resistance – Junction-to-Ambient (Note 3) – MOSFET	$R_{\theta JA}$	62.5	
Thermal Resistance – Junction-to-Ambient (Note 4) – Schottky	$R_{\theta JA}$	197	
Thermal Resistance – Junction-to-Ambient (Note 5) – Schottky	$R_{\theta JA}$	97	
Thermal Resistance – Junction-to-Ambient (Note 3) – Schottky	$R_{\theta JA}$	62.5	
Operating and Storage Temperature Range	$T_J, T_{stg}$	-55 to +150	

Stresses exceeding Maximum Ratings may damage the device. Maximum Ratings are stress ratings only. Functional operation above the Recommended Operating Conditions is not implied. Extended exposure to stresses above the Recommended Operating Conditions may affect device reliability.

3. Mounted on 2" square FR4 board (1 in sq, 2 oz. Cu 0.06" thick single sided), 10 sec. max.
4. Mounted with minimum recommended pad size, PC Board FR4.
5. Mounted on 2" square FR4 board (1 in sq, 2 oz. Cu 0.06" thick single sided), Steady State.

### SCHOTTKY RECTIFIER ELECTRICAL CHARACTERISTICS ( $T_C = 25^\circ\text{C}$ unless otherwise noted)

Characteristics	Symbol	Value		Unit
		$T_J = 25^\circ\text{C}$	$T_J = 125^\circ\text{C}$	
Maximum Instantaneous Forward Voltage (Note 6)  $I_F = 100 \text{ mAdc}$ $I_F = 3.0 \text{ Adc}$ $I_F = 6.0 \text{ Adc}$	$V_F$	$T_J = 25^\circ\text{C}$	$T_J = 125^\circ\text{C}$	Volts
		0.28	0.13	
		0.42	0.33	
		0.50	0.45	
Maximum Instantaneous Reverse Current (Note 6)  $V_R = 30 \text{ V}$	$I_R$	$T_J = 25^\circ\text{C}$	$T_J = 125^\circ\text{C}$	$\mu\text{A}$ mA
		250 -	- 25	
Maximum Voltage Rate of Change  $V_R = 30 \text{ V}$	$dV/dt$	10,000		V/ $\mu\text{s}$

6. Pulse Test: Pulse Width  $\leq 300 \mu\text{s}$ , Duty Cycle  $\leq 2.0\%$

# NTMSD6N303, NVMSD6N303

## MOSFET ELECTRICAL CHARACTERISTICS ( $T_C = 25^\circ\text{C}$ unless otherwise noted)

Characteristic	Symbol	Min	Typ	Max	Unit
----------------	--------	-----	-----	-----	------

### OFF CHARACTERISTICS

Drain-to-Source Breakdown Voltage ( $V_{GS} = 0\text{ Vdc}$ , $I_D = 250\ \mu\text{A}$ ) Temperature Coefficient (Positive)	$V_{(BR)DSS}$	30 -	- 30	- -	Vdc mV/ $^\circ\text{C}$
Zero Gate Voltage Drain Current ( $V_{DS} = 24\text{ Vdc}$ , $V_{GS} = 0\text{ Vdc}$ , $T_J = 25^\circ\text{C}$ ) ( $V_{DS} = 24\text{ Vdc}$ , $V_{GS} = 0\text{ Vdc}$ , $T_J = 125^\circ\text{C}$ )	$I_{DSS}$	- -	- -	1.0 20	$\mu\text{Adc}$
Gate-Body Leakage Current ( $V_{GS} = \pm 20\text{ Vdc}$ , $V_{DS} = 0\text{ Vdc}$ )	$I_{GSS}$	-	-	100	nAdc

### ON CHARACTERISTICS (Note 7)

Gate Threshold Voltage ( $V_{DS} = V_{GS}$ , $I_D = 250\ \mu\text{Adc}$ ) Temperature Coefficient (Negative)	$V_{GS(th)}$	1.0 -	1.8 4.6	2.5 -	Vdc mV/ $^\circ\text{C}$
Static Drain-to-Source On-State Resistance ( $V_{GS} = 10\text{ Vdc}$ , $I_D = 6\text{ Adc}$ ) ( $V_{GS} = 4.5\text{ Vdc}$ , $I_D = 3.9\text{ Adc}$ )	$R_{DS(on)}$	- -	0.024 0.030	0.032 0.040	$\Omega$
Forward Transconductance ( $V_{DS} = 15\text{ Vdc}$ , $I_D = 5.0\text{ Adc}$ )	$g_{FS}$	-	10	-	Mhos

### DYNAMIC CHARACTERISTICS

Input Capacitance	$(V_{DS} = 24\text{ Vdc}$ , $V_{GS} = 0\text{ Vdc}$ , $f = 1.0\text{ MHz}$ )	$C_{iss}$	-	680	950	pF
Output Capacitance		$C_{oss}$	-	210	300	
Reverse Transfer Capacitance		$C_{rss}$	-	70	135	

### SWITCHING CHARACTERISTICS (Notes 7 & 8)

Turn-On Delay Time	$(V_{DD} = 15\text{ Vdc}$ , $I_D = 1\text{ A}$ , $V_{GS} = 10\text{ V}$ , $R_G = 6\ \Omega$ )	$t_{d(on)}$	-	9	18	ns
Rise Time		$t_r$	-	22	40	
Turn-Off Delay Time		$t_{d(off)}$	-	45	80	
Fall Time		$t_f$	-	45	80	
Turn-On Delay Time	$(V_{DD} = 15\text{ Vdc}$ , $I_D = 1\text{ A}$ , $V_{GS} = 4.5\text{ V}$ , $R_G = 6\ \Omega$ )	$t_{d(on)}$	-	13	30	ns
Rise Time		$t_r$	-	27	50	
Turn-Off Delay Time		$t_{d(off)}$	-	22	40	
Fall Time		$t_f$	-	34	70	
Gate Charge	$(V_{DS} = 15\text{ Vdc}$ , $V_{GS} = 10\text{ Vdc}$ , $I_D = 5\text{ A}$ )	$Q_T$	-	19	30	nC
		$Q_1$	-	2.4	-	
		$Q_2$	-	5.0	-	
		$Q_3$	-	4.3	-	

### BODY-DRAIN DIODE RATINGS (Note 7)

Diode Forward On-Voltage	$(I_S = 1.7\text{ Adc}$ , $V_{GS} = 0\text{ V}$ ) $(I_S = 1.7\text{ Adc}$ , $V_{GS} = 0\text{ V}$ , $T_J = 150^\circ\text{C}$ )	$V_{SD}$	- -	0.75 0.62	1.0 -	Vdc
Reverse Recovery Time	$(I_S = 5\text{ A}$ , $V_{GS} = 0\text{ V}$ , $dI_S/dt = 100\text{ A}/\mu\text{s}$ )	$t_{rr}$	-	26	-	ns
		$t_a$	-	11	-	
		$t_b$	-	15	-	
Reverse Recovery Stored Charge ( $I_S = 5\text{ A}$ , $dI_S/dt = 100\text{ A}/\mu\text{s}$ , $V_{GS} = 0\text{ V}$ )		$Q_{RR}$	-	0.015	-	$\mu\text{C}$

7. Pulse Test: Pulse Width  $\leq 300\ \mu\text{s}$ , Duty Cycle  $\leq 2\%$ .

8. Switching characteristics are independent of operating junction temperature.

# NTMSD6N303, NVMSD6N303

## TYPICAL MOSFET ELECTRICAL CHARACTERISTICS

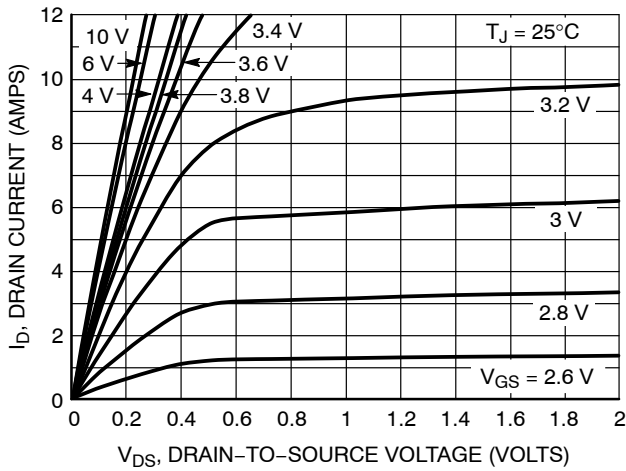

Figure 1. On-Region Characteristics

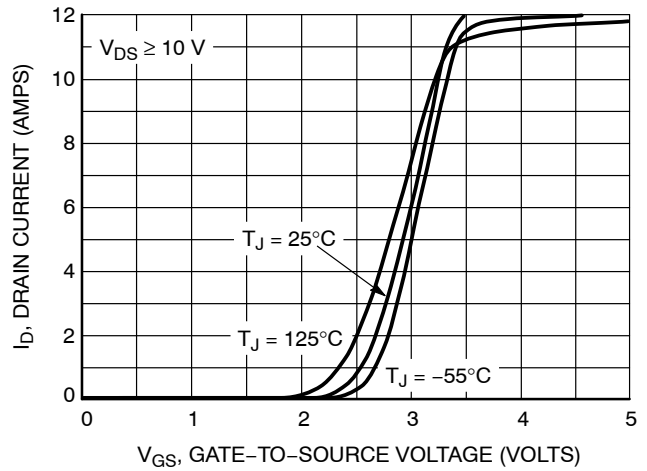

Figure 2. Transfer Characteristics

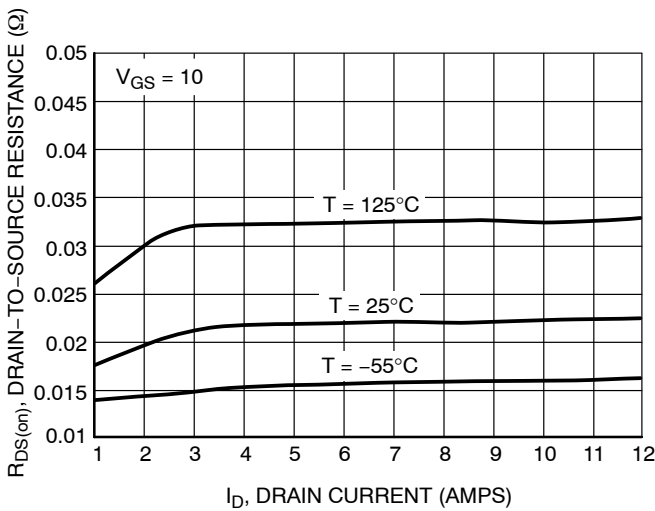

Figure 3. On-Resistance versus Drain Current and Temperature

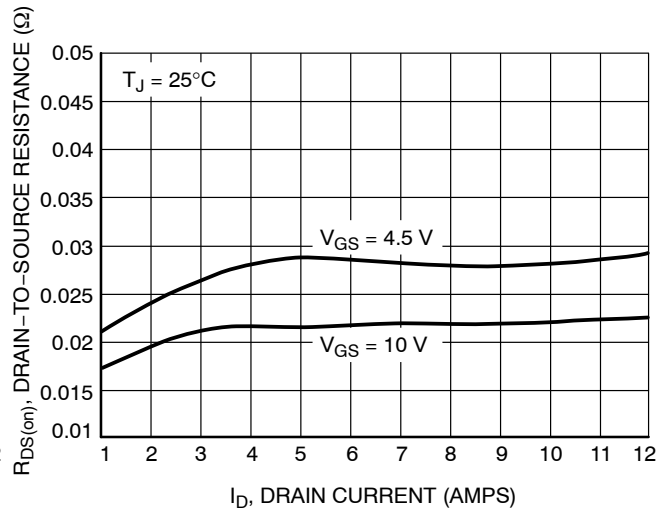

Figure 4. On-Resistance versus Drain Current and Gate Voltage

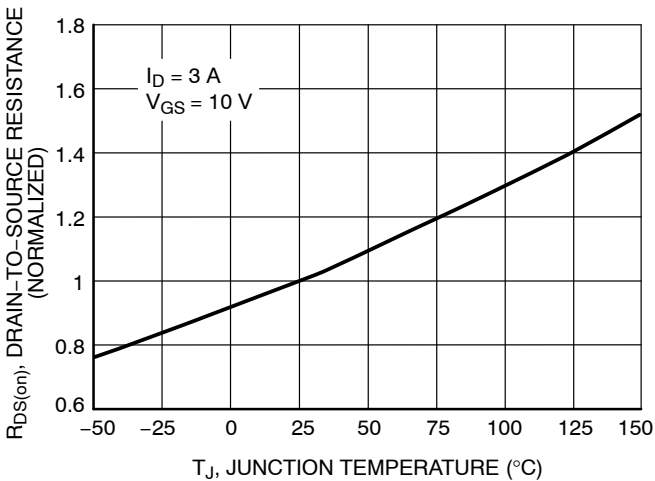

Figure 5. On-Resistance Variation with Temperature

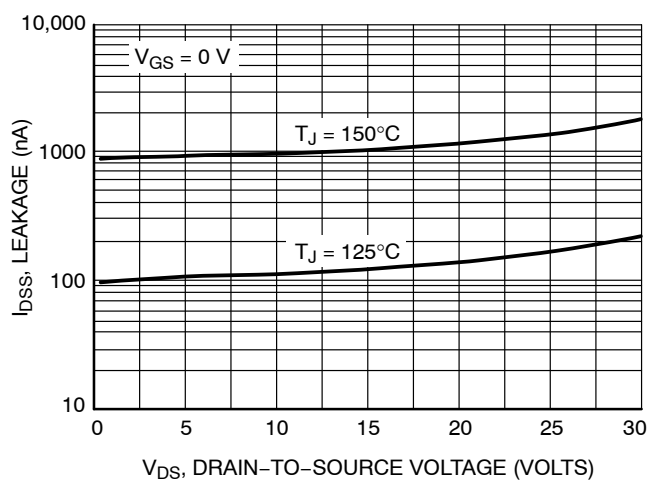
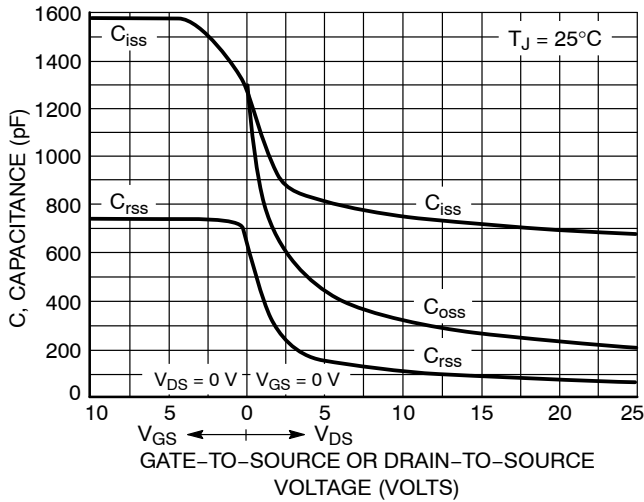
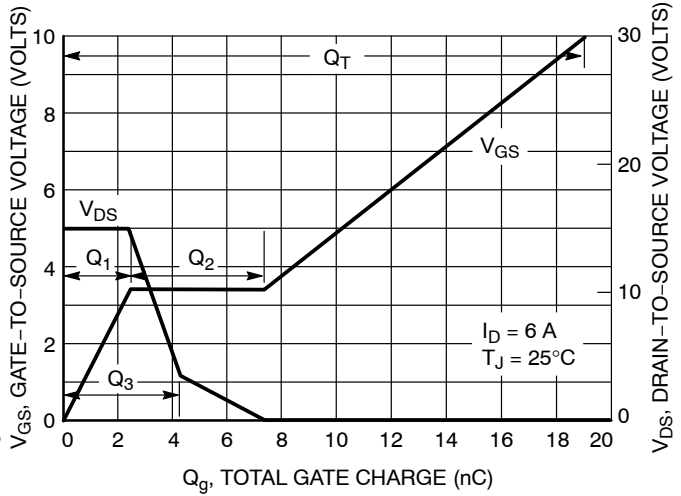

Figure 6. Drain-to-Source Leakage Current versus Voltage

# NTMSD6N303, NVMSD6N303



**Figure 7. Capacitance Variation**



**Figure 8. Gate-to-Source and Drain-to-Source Voltage versus Total Charge**

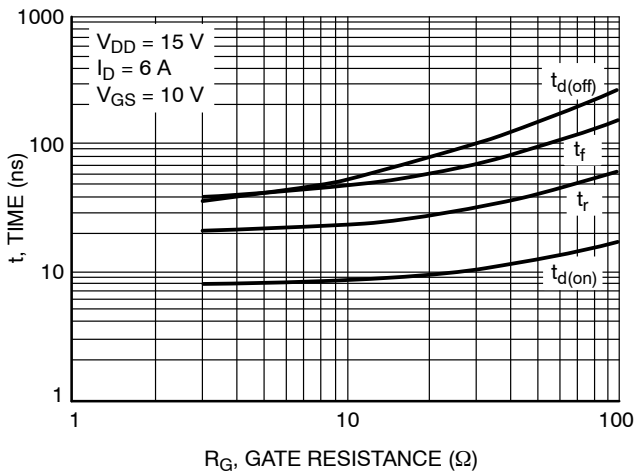

**Figure 9. Resistive Switching Time Variation versus Gate Resistance**

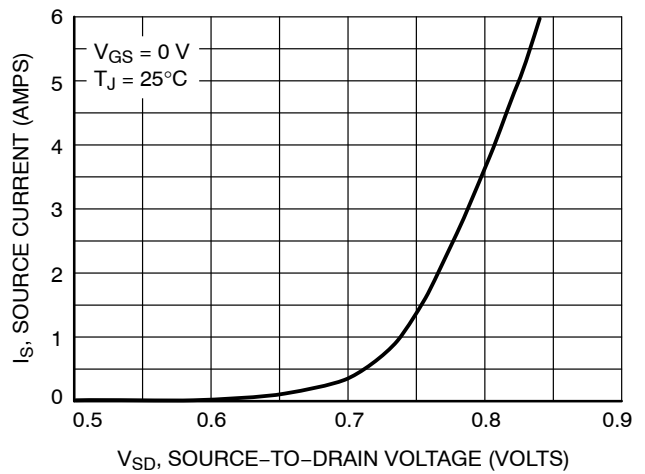

**Figure 10. Diode Forward Voltage versus Current**

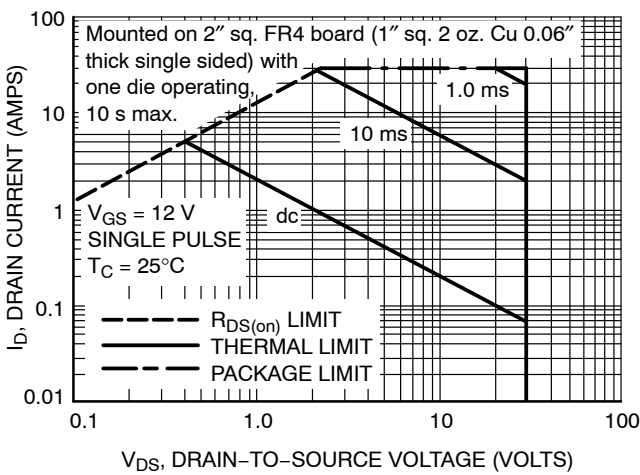

**Figure 11. Maximum Rated Forward Biased Safe Operating Area**

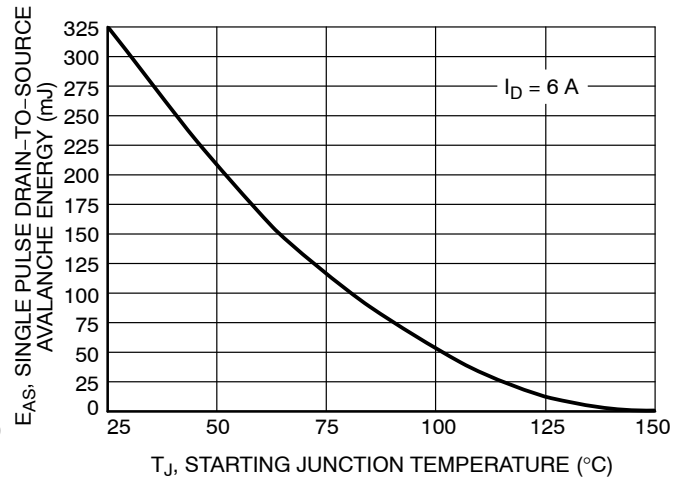

**Figure 12. Maximum Avalanche Energy versus Starting Junction Temperature**

# NTMSD6N303, NVMSD6N303

## TYPICAL FET ELECTRICAL CHARACTERISTICS

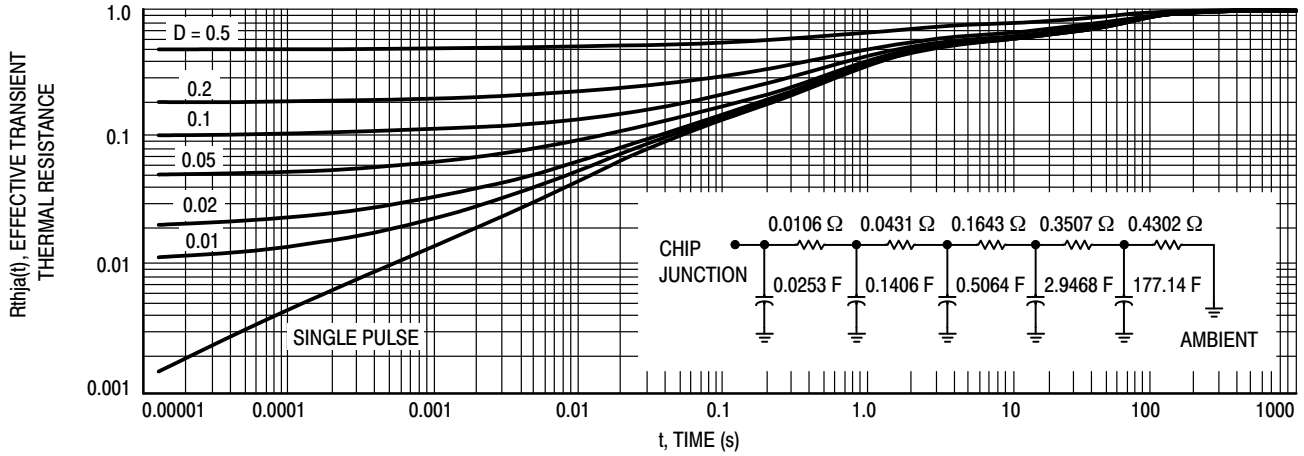

Figure 13. FET Thermal Response

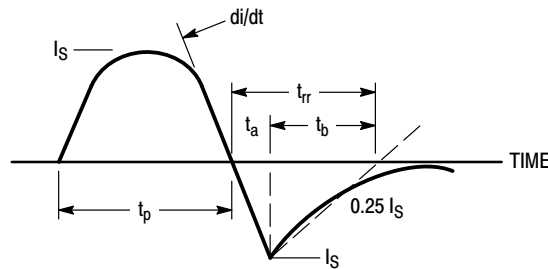

Figure 14. Diode Reverse Recovery Waveform

## TYPICAL SCHOTTKY ELECTRICAL CHARACTERISTICS

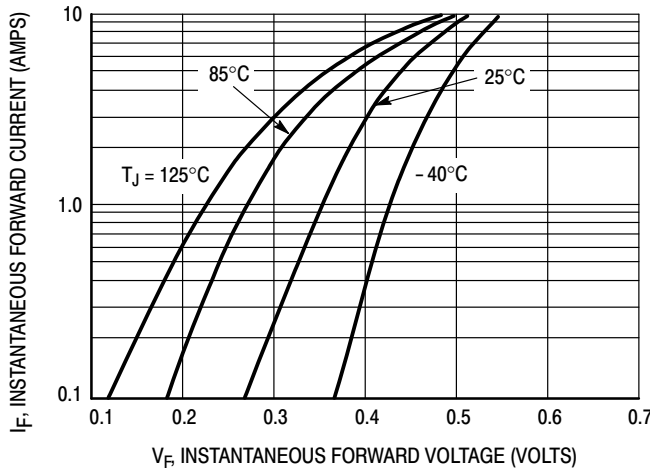

Figure 15. Typical Forward Voltage

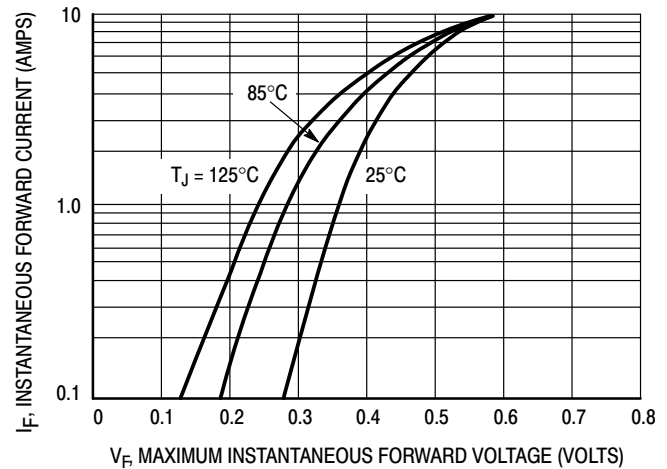

Figure 16. Maximum Forward Voltage

# NTMSD6N303, NVMSD6N303

## TYPICAL SCHOTTKY ELECTRICAL CHARACTERISTICS

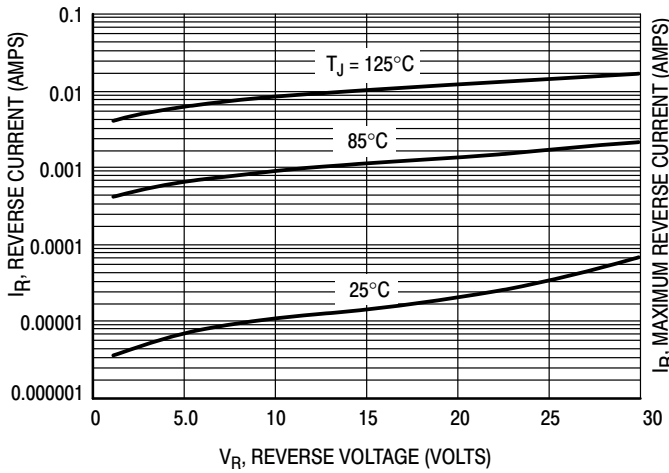

Figure 17. Typical Reverse Current

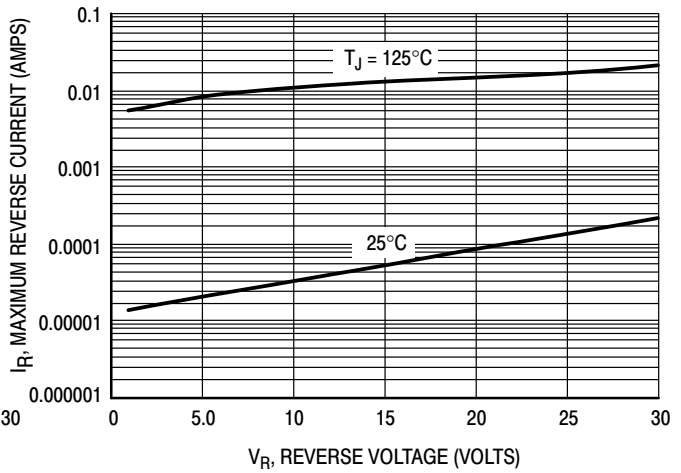

Figure 18. Maximum Reverse Current

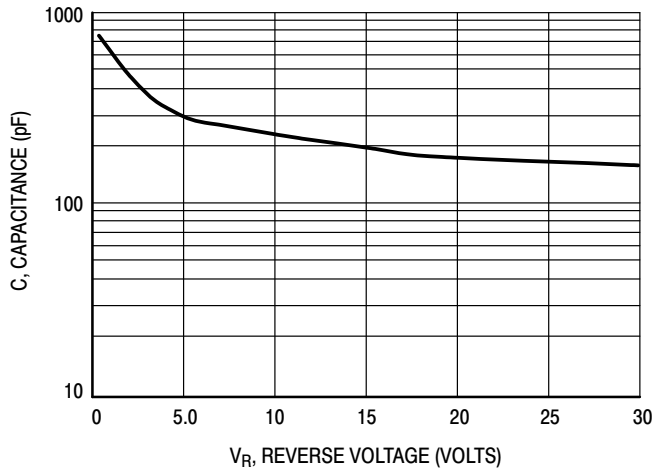

Figure 19. Typical Capacitance

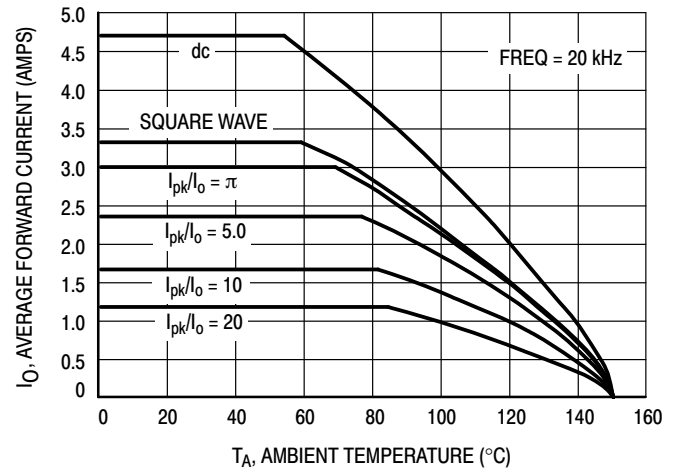

Figure 20. Current Derating

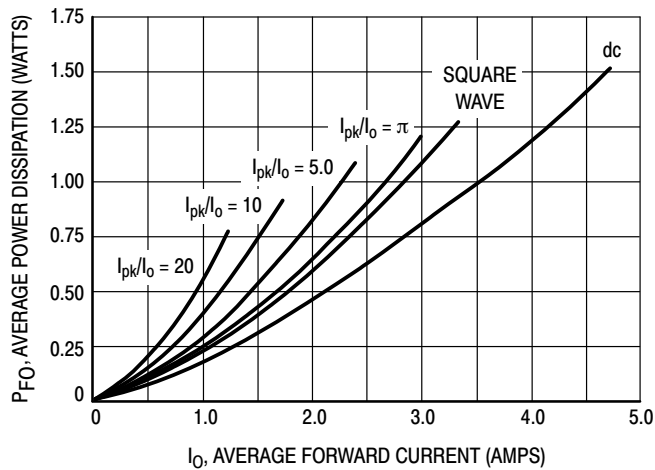

Figure 21. Forward Power Dissipation

# NTMSD6N303, NVMSD6N303

## TYPICAL SCHOTTKY ELECTRICAL CHARACTERISTICS

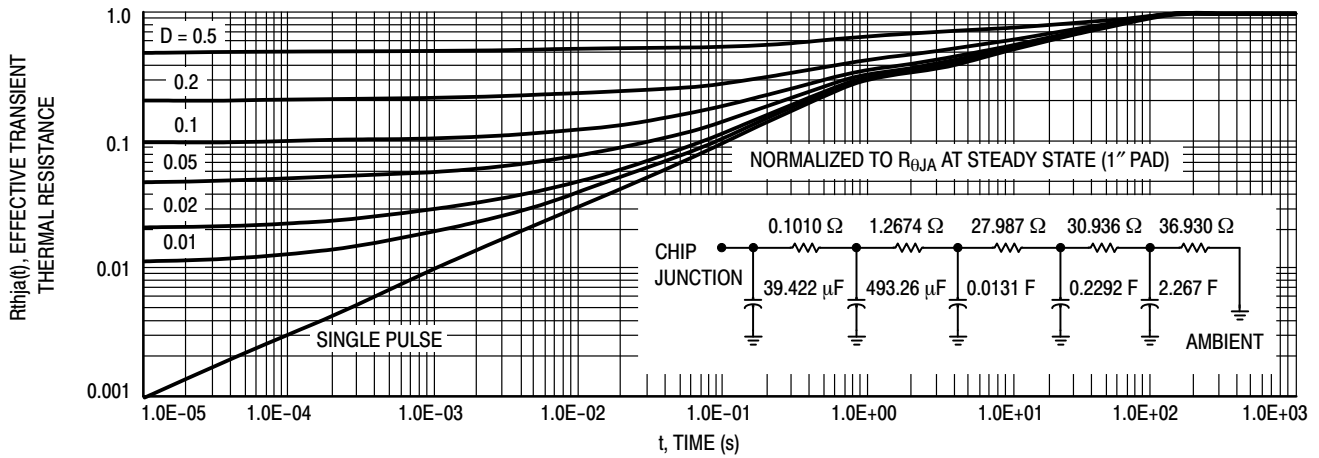
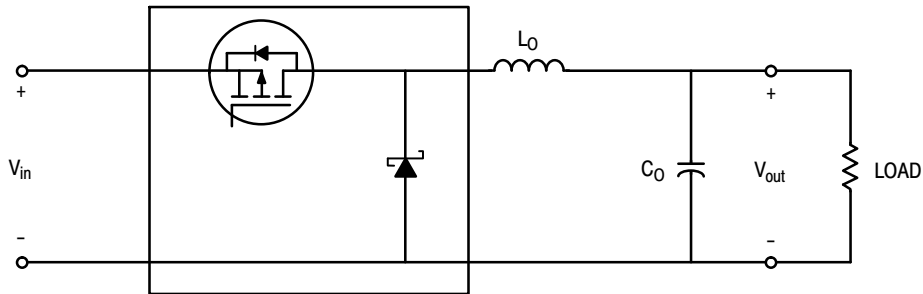

Figure 22. Schottky Thermal Response

## TYPICAL APPLICATIONS

### STEP DOWN SWITCHING REGULATORS



Buck Regulator

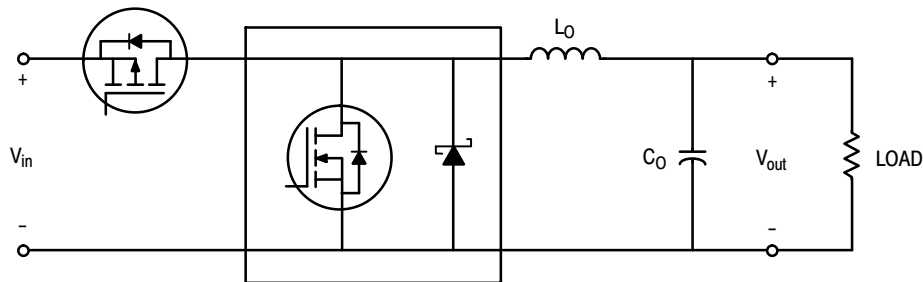

Synchronous Buck Regulator



# NTMSD6N303, NVMSD6N303

## TYPICAL APPLICATIONS

### STEP UP SWITCHING REGULATORS

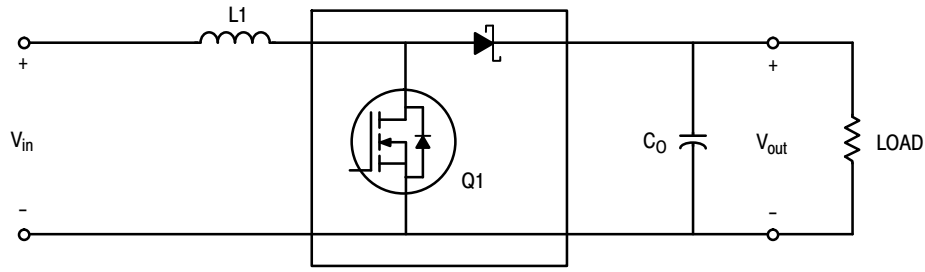

**Boost Regulator**

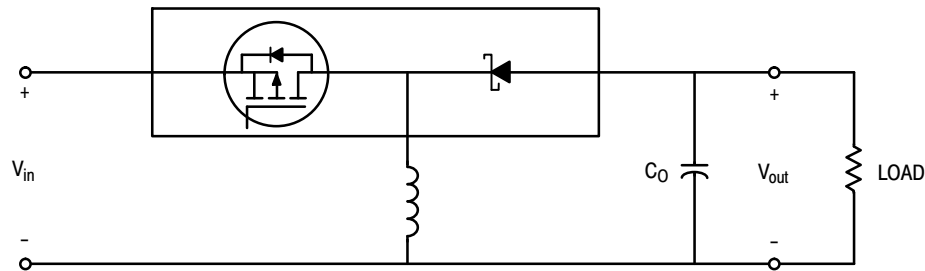

**Buck-Boost Regulator**

### MULTIPLE BATTERY CHARGERS

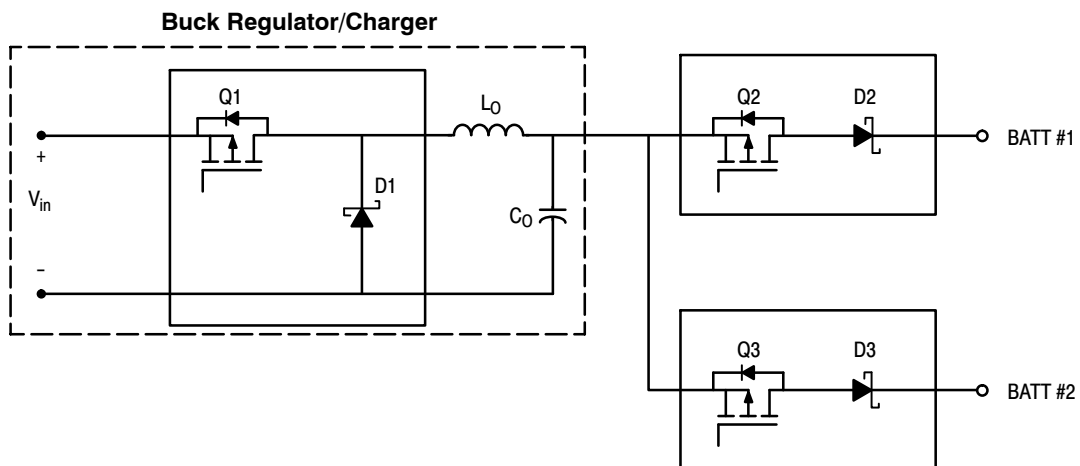

# NTMSD6N303, NVMSD6N303

## TYPICAL APPLICATIONS

### Li-Ion BATTERY PACK APPLICATIONS

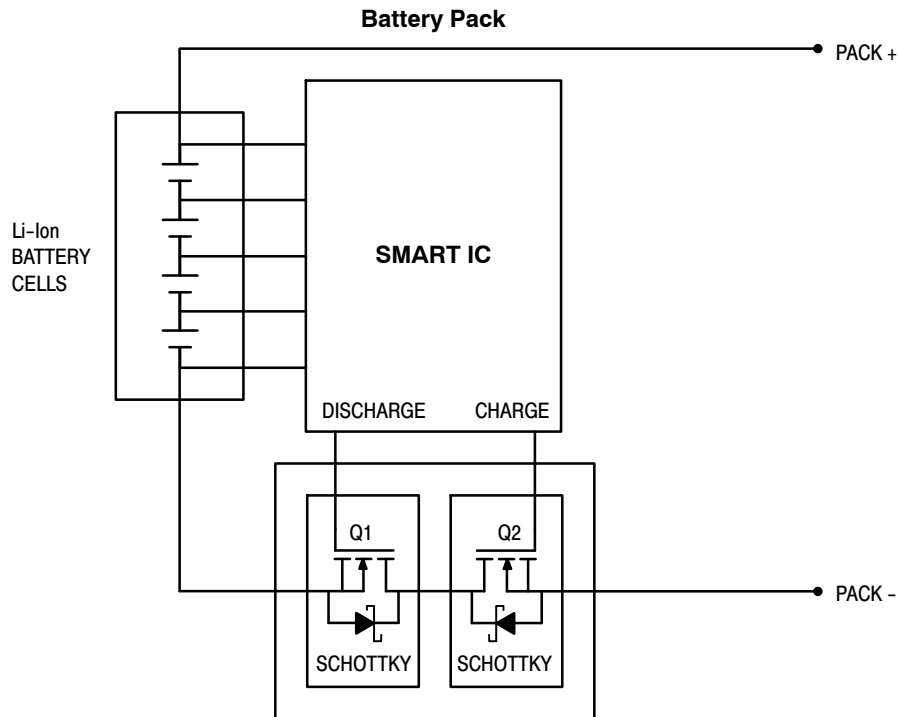

- Applicable in battery packs which require a high current level.
- During charge cycle Q2 is on and Q1 is off. Schottky can reduce power loss during fast charge.
- During discharge Q1 is on and Q2 is off. Again, Schottky can reduce power dissipation.
- Under normal operation, both transistors are on.

# MECHANICAL CASE OUTLINE PACKAGE DIMENSIONS



SCALE 1:1

SOIC-8 NB  
CASE 751-07  
ISSUE AK

DATE 16 FEB 2011



- NOTES:
1. DIMENSIONING AND TOLERANCING PER ANSI Y14.5M, 1982.
  2. CONTROLLING DIMENSION: MILLIMETER.
  3. DIMENSION A AND B DO NOT INCLUDE MOLD PROTRUSION.
  4. MAXIMUM MOLD PROTRUSION 0.15 (0.006) PER SIDE.
  5. DIMENSION D DOES NOT INCLUDE DAMBAR PROTRUSION. ALLOWABLE DAMBAR PROTRUSION SHALL BE 0.127 (0.005) TOTAL IN EXCESS OF THE D DIMENSION AT MAXIMUM MATERIAL CONDITION.
  6. 751-01 THRU 751-06 ARE OBSOLETE. NEW STANDARD IS 751-07.

DIM	MILLIMETERS		INCHES	
	MIN	MAX	MIN	MAX
A	4.80	5.00	0.189	0.197
B	3.80	4.00	0.150	0.157
C	1.35	1.75	0.053	0.069
D	0.33	0.51	0.013	0.020
G	1.27 BSC		0.050 BSC	
H	0.10	0.25	0.004	0.010
J	0.19	0.25	0.007	0.010
K	0.40	1.27	0.016	0.050
M	0°	8°	0°	8°
N	0.25	0.50	0.010	0.020
S	5.80	6.20	0.228	0.244

## GENERIC MARKING DIAGRAM\*

### SOLDERING FOOTPRINT\*



XXXXX = Specific Device Code  
A = Assembly Location  
L = Wafer Lot  
Y = Year  
W = Work Week  
▪ = Pb-Free Package

XXXXXX = Specific Device Code  
A = Assembly Location  
Y = Year  
WW = Work Week  
▪ = Pb-Free Package

\*This information is generic. Please refer to device data sheet for actual part marking. Pb-Free indicator, "G" or microdot "▪", may or may not be present. Some products may not follow the Generic Marking.

\*For additional information on our Pb-Free strategy and soldering details, please download the ON Semiconductor Soldering and Mounting Techniques Reference Manual, SOLDERRM/D.

## STYLES ON PAGE 2

DOCUMENT NUMBER:	98ASB42564B	Electronic versions are uncontrolled except when accessed directly from the Document Repository. Printed versions are uncontrolled except when stamped "CONTROLLED COPY" in red.
DESCRIPTION:	SOIC-8 NB	PAGE 1 OF 2

onsemi and ONsemi are trademarks of Semiconductor Components Industries, LLC dba onsemi or its subsidiaries in the United States and/or other countries. onsemi reserves the right to make changes without further notice to any products herein. onsemi makes no warranty, representation or guarantee regarding the suitability of its products for any particular purpose, nor does onsemi assume any liability arising out of the application or use of any product or circuit, and specifically disclaims any and all liability, including without limitation special, consequential or incidental damages. onsemi does not convey any license under its patent rights nor the rights of others.

**SOIC-8 NB**  
**CASE 751-07**  
**ISSUE AK**

DATE 16 FEB 2011

- |   |  |  |  |
|---|--|--|--|
| <p>STYLE 1:<br/>         PIN 1. EMITTER<br/>         2. COLLECTOR<br/>         3. COLLECTOR<br/>         4. EMITTER<br/>         5. EMITTER<br/>         6. BASE<br/>         7. BASE<br/>         8. EMITTER</p>   | <p>STYLE 2:<br/>         PIN 1. COLLECTOR, DIE, #1<br/>         2. COLLECTOR, #1<br/>         3. COLLECTOR, #2<br/>         4. COLLECTOR, #2<br/>         5. BASE, #2<br/>         6. EMITTER, #2<br/>         7. BASE, #1<br/>         8. EMITTER, #1</p>               | <p>STYLE 3:<br/>         PIN 1. DRAIN, DIE #1<br/>         2. DRAIN, #1<br/>         3. DRAIN, #2<br/>         4. DRAIN, #2<br/>         5. GATE, #2<br/>         6. SOURCE, #2<br/>         7. GATE, #1<br/>         8. SOURCE, #1</p>                            | <p>STYLE 4:<br/>         PIN 1. ANODE<br/>         2. ANODE<br/>         3. ANODE<br/>         4. ANODE<br/>         5. ANODE<br/>         6. ANODE<br/>         7. ANODE<br/>         8. COMMON CATHODE</p>   |
| <p>STYLE 5:<br/>         PIN 1. DRAIN<br/>         2. DRAIN<br/>         3. DRAIN<br/>         4. DRAIN<br/>         5. GATE<br/>         6. GATE<br/>         7. SOURCE<br/>         8. SOURCE</p>   | <p>STYLE 6:<br/>         PIN 1. SOURCE<br/>         2. DRAIN<br/>         3. DRAIN<br/>         4. SOURCE<br/>         5. SOURCE<br/>         6. GATE<br/>         7. GATE<br/>         8. SOURCE</p>  | <p>STYLE 7:<br/>         PIN 1. INPUT<br/>         2. EXTERNAL BYPASS<br/>         3. THIRD STAGE SOURCE<br/>         4. GROUND<br/>         5. DRAIN<br/>         6. GATE 3<br/>         7. SECOND STAGE Vd<br/>         8. FIRST STAGE Vd</p>                    | <p>STYLE 8:<br/>         PIN 1. COLLECTOR, DIE #1<br/>         2. BASE, #1<br/>         3. BASE, #2<br/>         4. COLLECTOR, #2<br/>         5. COLLECTOR, #2<br/>         6. EMITTER, #2<br/>         7. EMITTER, #1<br/>         8. COLLECTOR, #1</p>                              |
| <p>STYLE 9:<br/>         PIN 1. EMITTER, COMMON<br/>         2. COLLECTOR, DIE #1<br/>         3. COLLECTOR, DIE #2<br/>         4. EMITTER, COMMON<br/>         5. EMITTER, COMMON<br/>         6. BASE, DIE #2<br/>         7. BASE, DIE #1<br/>         8. EMITTER, COMMON</p> | <p>STYLE 10:<br/>         PIN 1. GROUND<br/>         2. BIAS 1<br/>         3. OUTPUT<br/>         4. GROUND<br/>         5. GROUND<br/>         6. BIAS 2<br/>         7. INPUT<br/>         8. GROUND</p>  | <p>STYLE 11:<br/>         PIN 1. SOURCE 1<br/>         2. GATE 1<br/>         3. SOURCE 2<br/>         4. GATE 2<br/>         5. DRAIN 2<br/>         6. DRAIN 2<br/>         7. DRAIN 1<br/>         8. DRAIN 1</p>   | <p>STYLE 12:<br/>         PIN 1. SOURCE<br/>         2. SOURCE<br/>         3. SOURCE<br/>         4. GATE<br/>         5. DRAIN<br/>         6. DRAIN<br/>         7. DRAIN<br/>         8. DRAIN</p>   |
| <p>STYLE 13:<br/>         PIN 1. N.C.<br/>         2. SOURCE<br/>         3. SOURCE<br/>         4. GATE<br/>         5. DRAIN<br/>         6. DRAIN<br/>         7. DRAIN<br/>         8. DRAIN</p>  | <p>STYLE 14:<br/>         PIN 1. N-SOURCE<br/>         2. N-GATE<br/>         3. P-SOURCE<br/>         4. P-GATE<br/>         5. P-DRAIN<br/>         6. P-DRAIN<br/>         7. N-DRAIN<br/>         8. N-DRAIN</p>   | <p>STYLE 15:<br/>         PIN 1. ANODE 1<br/>         2. ANODE 1<br/>         3. ANODE 1<br/>         4. ANODE 1<br/>         5. CATHODE, COMMON<br/>         6. CATHODE, COMMON<br/>         7. CATHODE, COMMON<br/>         8. CATHODE, COMMON</p>               | <p>STYLE 16:<br/>         PIN 1. EMITTER, DIE #1<br/>         2. BASE, DIE #1<br/>         3. EMITTER, DIE #2<br/>         4. BASE, DIE #2<br/>         5. COLLECTOR, DIE #2<br/>         6. COLLECTOR, DIE #2<br/>         7. COLLECTOR, DIE #1<br/>         8. COLLECTOR, DIE #1</p> |
| <p>STYLE 17:<br/>         PIN 1. VCC<br/>         2. V2OUT<br/>         3. V1OUT<br/>         4. TXE<br/>         5. RXE<br/>         6. VEE<br/>         7. GND<br/>         8. ACC</p>  | <p>STYLE 18:<br/>         PIN 1. ANODE<br/>         2. ANODE<br/>         3. SOURCE<br/>         4. GATE<br/>         5. DRAIN<br/>         6. DRAIN<br/>         7. CATHODE<br/>         8. CATHODE</p>   | <p>STYLE 19:<br/>         PIN 1. SOURCE 1<br/>         2. GATE 1<br/>         3. SOURCE 2<br/>         4. GATE 2<br/>         5. DRAIN 2<br/>         6. MIRROR 2<br/>         7. DRAIN 1<br/>         8. MIRROR 1</p>   | <p>STYLE 20:<br/>         PIN 1. SOURCE (N)<br/>         2. GATE (N)<br/>         3. SOURCE (P)<br/>         4. GATE (P)<br/>         5. DRAIN<br/>         6. DRAIN<br/>         7. DRAIN<br/>         8. DRAIN</p>   |
| <p>STYLE 21:<br/>         PIN 1. CATHODE 1<br/>         2. CATHODE 2<br/>         3. CATHODE 3<br/>         4. CATHODE 4<br/>         5. CATHODE 5<br/>         6. COMMON ANODE<br/>         7. COMMON ANODE<br/>         8. CATHODE 6</p>  | <p>STYLE 22:<br/>         PIN 1. I/O LINE 1<br/>         2. COMMON CATHODE/VCC<br/>         3. COMMON CATHODE/VCC<br/>         4. I/O LINE 3<br/>         5. COMMON ANODE/GND<br/>         6. I/O LINE 4<br/>         7. I/O LINE 5<br/>         8. COMMON ANODE/GND</p> | <p>STYLE 23:<br/>         PIN 1. LINE 1 IN<br/>         2. COMMON ANODE/GND<br/>         3. COMMON ANODE/GND<br/>         4. LINE 2 IN<br/>         5. LINE 2 OUT<br/>         6. COMMON ANODE/GND<br/>         7. COMMON ANODE/GND<br/>         8. LINE 1 OUT</p> | <p>STYLE 24:<br/>         PIN 1. BASE<br/>         2. EMITTER<br/>         3. COLLECTOR/ANODE<br/>         4. COLLECTOR/ANODE<br/>         5. CATHODE<br/>         6. CATHODE<br/>         7. COLLECTOR/ANODE<br/>         8. COLLECTOR/ANODE</p>                                      |
| <p>STYLE 25:<br/>         PIN 1. VIN<br/>         2. N/C<br/>         3. REXT<br/>         4. GND<br/>         5. IOUT<br/>         6. IOUT<br/>         7. IOUT<br/>         8. IOUT</p>   | <p>STYLE 26:<br/>         PIN 1. GND<br/>         2. dv/dt<br/>         3. ENABLE<br/>         4. ILIMIT<br/>         5. SOURCE<br/>         6. SOURCE<br/>         7. SOURCE<br/>         8. VCC</p>  | <p>STYLE 27:<br/>         PIN 1. ILIMIT<br/>         2. OVLO<br/>         3. UVLO<br/>         4. INPUT+<br/>         5. SOURCE<br/>         6. SOURCE<br/>         7. SOURCE<br/>         8. DRAIN</p>  | <p>STYLE 28:<br/>         PIN 1. SW_TO_GND<br/>         2. DASIC_OFF<br/>         3. DASIC_SW_DET<br/>         4. GND<br/>         5. V_MON<br/>         6. VBULK<br/>         7. VBULK<br/>         8. VIN</p>  |
| <p>STYLE 29:<br/>         PIN 1. BASE, DIE #1<br/>         2. EMITTER, #1<br/>         3. BASE, #2<br/>         4. EMITTER, #2<br/>         5. COLLECTOR, #2<br/>         6. COLLECTOR, #2<br/>         7. COLLECTOR, #1<br/>         8. COLLECTOR, #1</p>                        | <p>STYLE 30:<br/>         PIN 1. DRAIN 1<br/>         2. DRAIN 1<br/>         3. GATE 2<br/>         4. SOURCE 2<br/>         5. SOURCE 1/DRAIN 2<br/>         6. SOURCE 1/DRAIN 2<br/>         7. SOURCE 1/DRAIN 2<br/>         8. GATE 1</p>                           |  |  |

<b>DOCUMENT NUMBER:</b>	<b>98ASB42564B</b>	Electronic versions are uncontrolled except when accessed directly from the Document Repository. Printed versions are uncontrolled except when stamped "CONTROLLED COPY" in red.
<b>DESCRIPTION:</b>	<b>SOIC-8 NB</b>	<b>PAGE 2 OF 2</b>

**onsemi** and **ONSEMI** are trademarks of Semiconductor Components Industries, LLC dba **onsemi** or its subsidiaries in the United States and/or other countries. **onsemi** reserves the right to make changes without further notice to any products herein. **onsemi** makes no warranty, representation or guarantee regarding the suitability of its products for any particular purpose, nor does **onsemi** assume any liability arising out of the application or use of any product or circuit, and specifically disclaims any and all liability, including without limitation special, consequential or incidental damages. **onsemi** does not convey any license under its patent rights nor the rights of others.

**onsemi**, **Onsemi**, and other names, marks, and brands are registered and/or common law trademarks of Semiconductor Components Industries, LLC dba "**onsemi**" or its affiliates and/or subsidiaries in the United States and/or other countries. **onsemi** owns the rights to a number of patents, trademarks, copyrights, trade secrets, and other intellectual property. A listing of **onsemi**'s product/patent coverage may be accessed at [www.onsemi.com/site/pdf/Patent-Marking.pdf](http://www.onsemi.com/site/pdf/Patent-Marking.pdf). **onsemi** reserves the right to make changes at any time to any products or information herein, without notice. The information herein is provided "as-is" and **onsemi** makes no warranty, representation or guarantee regarding the accuracy of the information, product features, availability, functionality, or suitability of its products for any particular purpose, nor does **onsemi** assume any liability arising out of the application or use of any product or circuit, and specifically disclaims any and all liability, including without limitation special, consequential or incidental damages. Buyer is responsible for its products and applications using **onsemi** products, including compliance with all laws, regulations and safety requirements or standards, regardless of any support or applications information provided by **onsemi**. "Typical" parameters which may be provided in **onsemi** data sheets and/or specifications can and do vary in different applications and actual performance may vary over time. All operating parameters, including "Typicals" must be validated for each customer application by customer's technical experts. **onsemi** does not convey any license under any of its intellectual property rights nor the rights of others. **onsemi** products are not designed, intended, or authorized for use as a critical component in life support systems or any FDA Class 3 medical devices or medical devices with a same or similar classification in a foreign jurisdiction or any devices intended for implantation in the human body. Should Buyer purchase or use **onsemi** products for any such unintended or unauthorized application, Buyer shall indemnify and hold **onsemi** and its officers, employees, subsidiaries, affiliates, and distributors harmless against all claims, costs, damages, and expenses, and reasonable attorney fees arising out of, directly or indirectly, any claim of personal injury or death associated with such unintended or unauthorized use, even if such claim alleges that **onsemi** was negligent regarding the design or manufacture of the part. **onsemi** is an Equal Opportunity/Affirmative Action Employer. This literature is subject to all applicable copyright laws and is not for resale in any manner.

## PUBLICATION ORDERING INFORMATION

### LITERATURE FULFILLMENT:

Email Requests to: [orderlit@onsemi.com](mailto:orderlit@onsemi.com)

**onsemi Website:** [www.onsemi.com](http://www.onsemi.com)

### TECHNICAL SUPPORT

**North American Technical Support:**

Voice Mail: 1 800-282-9855 Toll Free USA/Canada

Phone: 011 421 33 790 2910

**Europe, Middle East and Africa Technical Support:**

Phone: 00421 33 790 2910

For additional information, please contact your local Sales Representative