

ADS54J66 Quad-Channel, 14-Bit, 500-MSPS ADC with Integrated DDC

1 Features

- Quad Channel
- 14-Bit Resolution
- Maximum Clock Rate: 500 MSPS
- Input Bandwidth (3 dB): 900 MHz
- On-Chip Dither
- Analog Input Buffer with High-Impedance Input
- Output Options:
 - Rx: Decimate-by-2 and -4 Options with Low-Pass Filter
 - 200-MHz Complex Bandwidth or 100-MHz Real Bandwidth Support
 - DPD FB: 500 MSPS
- 1.9-V_{PP} Differential Full-Scale Input
- JESD204B Interface:
 - Subclass 1 Support
 - 1 Lane per ADC Up to 10 Gbps
 - Dedicated SYNC Pin for Pair of Channels
- Support for Multi-Chip Synchronization
- 72-Pin VQFN Package (10 mm x 10 mm)
- Key Specifications:
 - Power Dissipation: 675 mW/ch
 - Spectral Performance (Un-Decimated)
 - $f_{IN} = 190$ MHz IF at -1 dBFS:
 - SNR: 69.5 dBFS
 - NSD: -153.5 dBFS/Hz
 - SFDR: 86 dBc (HD2, HD3), 93 dBFS (Non HD2, HD3)
 - $f_{IN} = 370$ MHz IF at -3 dBFS:
 - SNR: 68.5 dBFS
 - NSD: -152.5 dBFS/Hz
 - SFDR: 81 dBc (HD2, HD3), 86 dBFS (Non HD2, HD3)

2 Applications

- Radar and Antenna Arrays
- Broadband Wireless and Digitizers
- Cable CMTS, DOCSIS 3.1 Receivers
- Communications Test Equipment
- Microwave Receivers
- Software Defined Radio (SDR)

3 Description

The ADS54J66 is a low-power, wide-bandwidth, 14-bit, 500-MSPS, quad-channel, telecom receiver device. The ADS54J66 supports a JESD204B serial interface with data rates up to 10 Gbps with one lane per channel. The buffered analog input provides uniform input impedance across a wide frequency range and minimizes sample-and-hold glitch energy. The ADS54J66 provides excellent spurious-free dynamic range (SFDR) over a large input frequency range with very low power consumption. The digital signal processing block includes complex mixers followed by low-pass filters with decimate-by-2 and -4 options supporting up to 200-MHz receive bandwidth.

The JESD204B interface reduces the number of interface lines, thus allowing high system integration density. An internal phase-locked loop (PLL) multiplies the incoming analog-to-digital converter (ADC) sampling clock to derive the bit clock, which is used to serialize the 14-bit data from each channel.

Device Information⁽¹⁾

PART NUMBER	PACKAGE	BODY SIZE (NOM)
ADS54J66	VQFN (72)	10.00 mm x 10.00 mm

(1) For all available packages, see the orderable addendum at the end of the data sheet.

Simplified Block Diagram

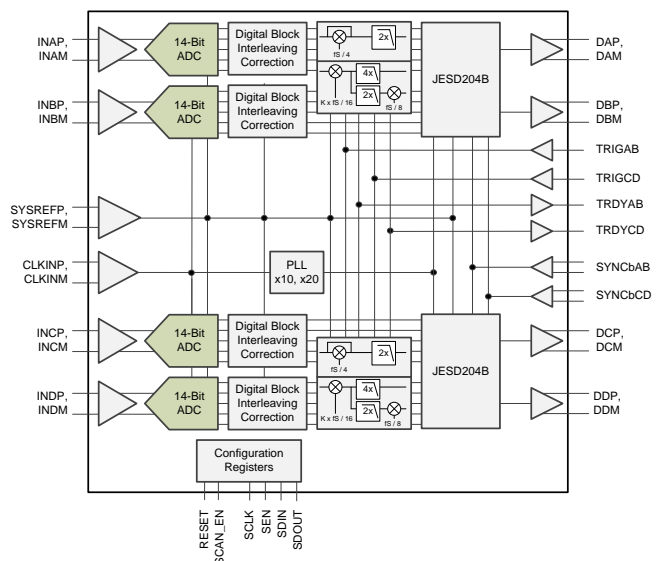

Table of Contents

1 Features	1	7.2 Functional Block Diagram	21
2 Applications	1	7.3 Feature Description.....	22
3 Description	1	7.4 Device Functional Modes.....	23
4 Revision History	2	7.5 Programming	31
5 Pin Configuration and Functions	3	7.6 Register Maps.....	41
6 Specifications	5	8 Application and Implementation	69
6.1 Absolute Maximum Ratings	5	8.1 Application Information.....	69
6.2 ESD Ratings.....	5	8.2 Typical Application	73
6.3 Recommended Operating Conditions.....	6	9 Power Supply Recommendations	74
6.4 Thermal Information	6	10 Layout	75
6.5 Electrical Characteristics.....	7	10.1 Layout Guidelines	75
6.6 AC Performance	8	10.2 Layout Example	75
6.7 Digital Characteristics	10	11 Device and Documentation Support	76
6.8 Timing Characteristics.....	11	11.1 Community Resources.....	76
6.9 Typical Characteristics: General (DDC Mode-8).....	12	11.2 Trademarks	76
6.10 Typical Characteristics: Mode 2.....	19	11.3 Electrostatic Discharge Caution.....	76
6.11 Typical Characteristics: Mode 0.....	20	11.4 Glossary	76
7 Detailed Description	21	12 Mechanical, Packaging, and Orderable Information	76
7.1 Overview	21		

4 Revision History

Changes from Original (November 2015) to Revision A

Page

• Changed Table 8 : changed several comments, added rows	29
• Changed Figure 84 : changed last value of JESD bank page address	41
• Changed Table 15 : changed ADC page registers 5Fh to 6Dh.....	42
• Changed description of decimation mode 0 to mode 4 in <i>Example Register Writes</i> section: deleted (<i>default</i>)	44
• Changed <i>Register 5Fh</i> , <i>Register 60h</i> , and <i>Register 61h</i>	51
• Changed <i>Register 6Ch</i> and <i>Register 6Dh</i>	52
• Changed <i>Start-Up Sequence</i> section	69

5 Pin Configuration and Functions

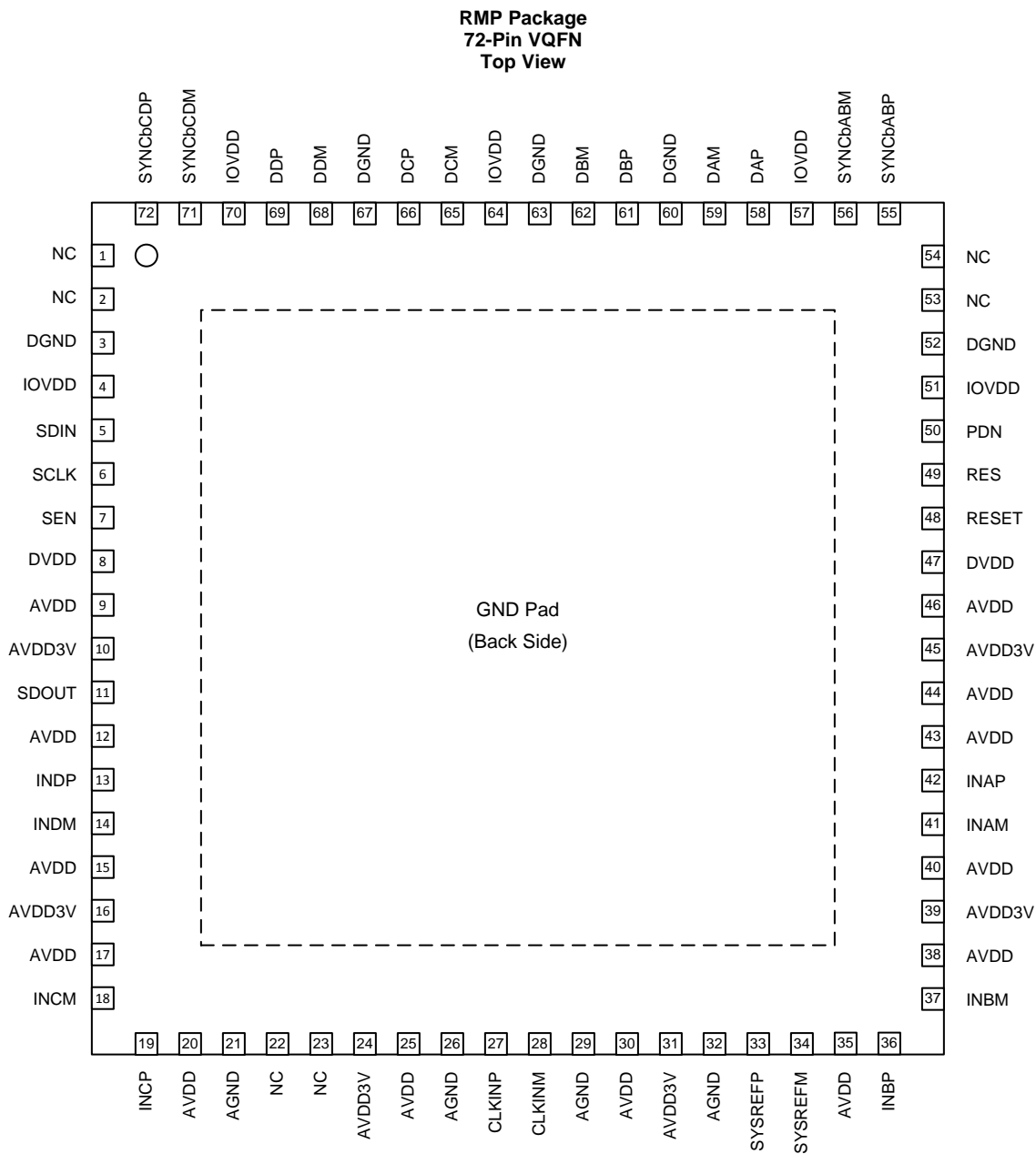

Pin Functions

PIN		I/O	DESCRIPTION
NAME	NUMBER		
INPUT, REFERENCE			
INAM	41	I	Differential analog input pins for channel A
INAP	42		
INBM	37	I	Differential analog input pins for channel B
INBP	36		
INCM	18	I	Differential analog input pins for channel C
INCP	19		
INDM	14	I	Differential analog input pins for channel D
INDP	13		
CLOCK, SYNC			
CLKINM	28	I	Differential clock input pins for the ADC
CLKINP	27		
SYSREFM	34	I	External sync input pins
SYSREFP	33		
CONTROL, SERIAL			
DAM	59	O	JESD204B Serial data output pins for channel A
DAP	58		
DBM	62	O	JESD204B Serial data output pins for channel B
DBP	61		
DCM	65	O	JESD204B Serial data output pins for channel C
DCP	66		
DDM	68	O	JESD204B Serial data output pins for channel D
DDP	69		
NC	1, 2, 22, 23, 53, 54	–	Do not connect
PDN	50	I/O	Power down. Can be configured via SPI register setting.
RES	49	–	Reserve pin. Connect to GND
RESET	48	I	Hardware reset. Active high. This pin has an internal 150-kΩ pulldown resistor.
SCLK	6	I	Serial interface clock input
SDIN	5	I	Serial interface data input.
SDOUT	11	O	Serial interface data output.
SEN	7	I	Serial interface enable
SYNCbABM	56	I	Synchronization input pins for JESD204B port channel A, B. Can be configured via SPI to SYNCb signal for all four channels. Needs external termination.
SYNCbABP	55		
SYNCbCDM	71	I	Synchronization input pins for JESD204B port channel C, D. Can be configured via SPI to SYNCb signal for all four channels. Needs external termination.
SYNCbCDP	72		

Pin Functions (continued)

PIN		I/O	DESCRIPTION
NAME	NUMBER		
POWER SUPPLY			
AGND	21, 26, 29, 32	I	Analog ground
AVDD	9, 12, 15, 17, 20, 25, 30, 35, 38, 40, 43, 44, 46	I	Analog 1.9-V power supply
AVDD3V	10, 16, 24, 31, 39, 45	I	Analog 3 V for analog buffer
DGND	3, 52, 60, 63, 67	I	Digital ground
DVDD	8, 47	I	Digital 1.9-V power supply
IOVDD	4, 51, 57, 64, 70	I	Digital 1.15-V power supply for the JESD204B transmitter

6 Specifications

6.1 Absolute Maximum Ratings

over operating free-air temperature range (unless otherwise noted)⁽¹⁾

		MIN	MAX	UNIT
Supply voltage range	AVDD3V	-0.3	3.6	V
	AVDD	-0.3	2.1	
	DVDD	-0.3	2.1	
	IOVDD	-0.2	1.4	
Voltage between AGND and DGND		-0.3	0.3	V
Voltage applied to input pins	INAP, INBP, INAM, INBM, INCP, INDP, INCM, INDM	-0.3	3	V
	CLKINP, CLKINM	-0.3	AVDD + 0.3	
	SYSREFP, SYSREFM	-0.3	AVDD + 0.3	
	SCLK, SEN, SDIN, RESET, SPI_MODE, SYNCbABP, SYNCbABM, SYNCbCDP, SYNCbCDM, PDN	-0.2	2	
Storage temperature, T _{stg}		-65	150	°C

(1) Stresses beyond those listed under *Absolute Maximum Ratings* may cause permanent damage to the device. These are stress ratings only, which do not imply functional operation of the device at these or any other conditions beyond those indicated under *Recommended Operating Conditions*. Exposure to absolute-maximum-rated conditions for extended periods may affect device reliability.

6.2 ESD Ratings

		VALUE	UNIT
V _(ESD)	Electrostatic discharge	Human-body model (HBM), per ANSI/ESDA/JEDEC JS-001 ⁽¹⁾	±1000 V

(1) JEDEC document JEP155 states that 500-V HBM allows safe manufacturing with a standard ESD control process.

6.3 Recommended Operating Conditions

 over operating free-air temperature range (unless otherwise noted)⁽¹⁾

		MIN	NOM	MAX	UNIT
Supply voltage range	AVDD3V	2.85	3	3.6	V
	AVDD	1.8	1.9	2	
	DVDD	1.8	1.9	2	
	IOVDD	1.1	1.15	1.2	
Analog inputs	Differential input voltage range	1.9			V _{PP}
	Input common-mode voltage	2.0 ± 0.025			V
Clock inputs	Input clock frequency, device clock frequency		250	500	MHz
	Input clock amplitude differential (V _{CLKP} – V _{CLKM})	Sine wave, ac-coupled		1.5	V _{PP}
		LVPECL, ac-coupled		1.6	
		LVDS, ac-coupled		0.7	
Input device clock duty cycle, default after reset		45%	50%	55%	
Temperature	Operating free-air, T _A		–40	85	°C
	Operating junction, T _J		105 ⁽²⁾		

(1) SYSREF must be applied for the device initialization.

(2) Prolonged use above this junction temperature can increase the device failure-in-time (FIT) rate.

6.4 Thermal Information

THERMAL METRIC ⁽¹⁾		ADS54J66	UNIT
		RMP (VQFN)	
		72 PINS	
R _{θJA}	Junction-to-ambient thermal resistance	22.3	°C/W
R _{θJC(top)}	Junction-to-case (top) thermal resistance	5.1	°C/W
R _{θJB}	Junction-to-board thermal resistance	2.4	°C/W
Ψ _{JT}	Junction-to-top characterization parameter	0.1	°C/W
Ψ _{JB}	Junction-to-board characterization parameter	2.3	°C/W
R _{θJC(bot)}	Junction-to-case (bottom) thermal resistance	0.4	°C/W

 (1) For more information about traditional and new thermal metrics, see the *IC Package Thermal Metrics* application report, [SPRA953](http://www.ti.com/lit/zip/SRPA953).

6.5 Electrical Characteristics

typical values are at $T_A = 25^\circ\text{C}$, full temperature range is from $T_{\text{MIN}} = -40^\circ\text{C}$ to $T_{\text{MAX}} = 85^\circ\text{C}$, ADC sampling frequency = 500 MSPS, 50% clock duty cycle, AVDD3V = 3 V, AVDD = DVDD = 1.9 V, IOVDD = 1.15 V, –1-dBFS differential input for IF ≤ 250 MHz, and –3-dBFS differential input for IF > 250 MHz (unless otherwise noted)

PARAMETER	TEST CONDITIONS	MIN	TYP	MAX	UNIT	
GENERAL						
ADC sampling rate				500	MSPS	
Resolution		14			Bits	
POWER SUPPLY						
AVDD3V	3-V analog supply	2.85	3	3.6	V	
AVDD	1.9-V analog supply	1.8	1.9	2	V	
DVDD	1.9-V digital supply	1.8	1.9	2	V	
IOVDD	1.15-V SERDES supply	1.1	1.15	1.2	V	
I_{AVDD3V}	3-V analog supply current	370-MHz, full-scale input on all four channels			340	mA
I_{AVDD}	1.9-V analog supply current	370-MHz, full-scale input on all four channels			365	mA
I_{DVDD}	1.9-V digital supply current	2x decimation (4 channels), 370 MHz, full-scale input on all four channels			190	mA
		DDC mode-8 (no decimation), 370 MHz, full-scale input on all four channels			184	
I_{IOVDD}	1.15-V SERDES supply current	DDC mode-8 (no decimation), 370 MHz, full-scale input on all four channels			533	mA
Pdis	Total power dissipation	2x decimation (4 channels), 370 MHz, full-scale input on all four channels			2.68	W
		DDC mode-8 (no decimation), 370 MHz, full-scale input on all four channels			2.67	
	Global power-down power dissipation	Full-scale input on all four channels			250	mW
ANALOG INPUTS						
	Differential input full-scale voltage		1.9		V_{PP}	
	Input common-mode voltage		2.0		V	
	Differential input resistance	At $f_{\text{IN}} = 370$ MHz			0.5	k Ω
	Differential input capacitance	At $f_{\text{IN}} = 370$ MHz			2.5	pF
	Analog input bandwidth (3 dB)		900		MHz	
ISOLATION						
Crosstalk ⁽¹⁾ isolation between near channels (channels A and B are near to each other, channels C and D are near to each other)	$f_{\text{IN}} = 10$ MHz		105		dBFS	
	$f_{\text{IN}} = 100$ MHz		104			
	$f_{\text{IN}} = 170$ MHz		96			
	$f_{\text{IN}} = 270$ MHz		97			
	$f_{\text{IN}} = 370$ MHz		93			
	$f_{\text{IN}} = 470$ MHz		85			
Crosstalk ⁽¹⁾ isolation between far channels (channels A and B, and channels C and D are far channels)	$f_{\text{IN}} = 10$ MHz		110		dBFS	
	$f_{\text{IN}} = 100$ MHz		107			
	$f_{\text{IN}} = 170$ MHz		96			
	$f_{\text{IN}} = 270$ MHz		97			
	$f_{\text{IN}} = 370$ MHz		95			
	$f_{\text{IN}} = 470$ MHz		94			
CLOCK INPUT						
Internal clock biasing	CLKINP and CLKINM pins are connected to internal biasing voltage through 400 Ω		1.15		V	

(1) Crosstalk is measured with a –1-dBFS input signal on aggressor channel and no input on the victim channel.

6.6 AC Performance

over operating free-air temperature range (unless otherwise noted)

PARAMETER	TEST CONDITIONS	NO DECIMATION, 500-MSPS OUTPUT (DDC Mode 8)			DECIMATE-BY-2, 250-MSPS OUTPUT (DDC Mode 2)			UNIT
		MIN	TYP	MAX	MIN	TYP	MAX	
SNR Signal-to-noise ratio	$f_{IN} = 10$ MHz		70.8			74.1		dBFS
	$f_{IN} = 70$ MHz		70.5			74		
	$f_{IN} = 190$ MHz, $A_{IN} = -1$ dBFS		69.5			73.2		
	$f_{IN} = 190$ MHz, $A_{IN} = -3$ dBFS	65.6	70.3			73.6		
	$f_{IN} = 300$ MHz		69			72.6		
	$f_{IN} = 350$ MHz		68.7			72		
	$f_{IN} = 370$ MHz	64.6	68.4			71.5		
	$f_{IN} = 470$ MHz		67.5			70.7		
NSD Noise spectral density	$f_{IN} = 10$ MHz		154.8			155.1		dBFS/Hz
	$f_{IN} = 70$ MHz		154.5			155		
	$f_{IN} = 190$ MHz, $A_{IN} = -1$ dBFS		153.5			154.2		
	$f_{IN} = 190$ MHz, $A_{IN} = -3$ dBFS	149.6	154.3			154.6		
	$f_{IN} = 300$ MHz		153			153.6		
	$f_{IN} = 350$ MHz		152.7			153		
	$f_{IN} = 370$ MHz	148.6	152.4			152.5		
	$f_{IN} = 470$ MHz		151.5			151.7		
SINAD Signal-to-noise and distortion ratio	$f_{IN} = 10$ MHz		70.7			73.9		dBFS
	$f_{IN} = 70$ MHz		70.4			73.9		
	$f_{IN} = 190$ MHz, $A_{IN} = -1$ dBFS		69.4			73.1		
	$f_{IN} = 190$ MHz, $A_{IN} = -3$ dBFS		70.2			73.5		
	$f_{IN} = 300$ MHz		68.9			72.5		
	$f_{IN} = 350$ MHz		68.6			71.7		
	$f_{IN} = 370$ MHz		68.2					
	$f_{IN} = 470$ MHz		66.9			69.7		
SFDR Spurious-free dynamic range	$f_{IN} = 10$ MHz		89			88		dBc
	$f_{IN} = 70$ MHz		87			95		
	$f_{IN} = 190$ MHz, $A_{IN} = -1$ dBFS		86			97		
	$f_{IN} = 190$ MHz, $A_{IN} = -3$ dBFS	78	88			96		
	$f_{IN} = 300$ MHz		82			94		
	$f_{IN} = 350$ MHz		82			82		
	$f_{IN} = 370$ MHz	75	81					
	$f_{IN} = 470$ MHz		73			74		
HD2 Second-order harmonic distortion	$f_{IN} = 10$ MHz		89			91		dBc
	$f_{IN} = 70$ MHz		94			103		
	$f_{IN} = 190$ MHz, $A_{IN} = -1$ dBFS		86			101		
	$f_{IN} = 190$ MHz, $A_{IN} = -3$ dBFS	78	88			101		
	$f_{IN} = 300$ MHz		82			97		
	$f_{IN} = 350$ MHz		82			82		
	$f_{IN} = 370$ MHz	75	81					
	$f_{IN} = 470$ MHz		73			74		

AC Performance (continued)

over operating free-air temperature range (unless otherwise noted)

PARAMETER	TEST CONDITIONS	NO DECIMATION, 500-MSPS OUTPUT (DDC Mode 8)			DECIMATE-BY-2, 250-MSPS OUTPUT (DDC Mode 2)			UNIT
		MIN	TYP	MAX	MIN	TYP	MAX	
HD3	Third-order harmonic distortion	$f_{IN} = 10 \text{ MHz}$		93		88		dBc
		$f_{IN} = 70 \text{ MHz}$		87		99		
		$f_{IN} = 190 \text{ MHz}, A_{IN} = -1 \text{ dBFS}$		98		100		
		$f_{IN} = 190 \text{ MHz}, A_{IN} = -3 \text{ dBFS}$	78	97		98		
		$f_{IN} = 300 \text{ MHz}$		95		100		
		$f_{IN} = 350 \text{ MHz}$		90		96		
		$f_{IN} = 370 \text{ MHz}$	75	85				
		$f_{IN} = 470 \text{ MHz}$		83		83		
Non HD2, HD3	Spurious-free dynamic range (excluding HD2, HD3)	$f_{IN} = 10 \text{ MHz}$		94		98		dBc
		$f_{IN} = 70 \text{ MHz}$		94		95		
		$f_{IN} = 190 \text{ MHz}, A_{IN} = -1 \text{ dBFS}$		93		97		
		$f_{IN} = 190 \text{ MHz}, A_{IN} = -3 \text{ dBFS}$	87	93		96		
		$f_{IN} = 300 \text{ MHz}$		92		94		
		$f_{IN} = 350 \text{ MHz}$		91		94		
		$f_{IN} = 370 \text{ MHz}$	80	90				
		$f_{IN} = 470 \text{ MHz}$		87		93		
THD	Total harmonic distortion	$f_{IN} = 10 \text{ MHz}$		88		86		dBc
		$f_{IN} = 70 \text{ MHz}$		85		92		
		$f_{IN} = 190 \text{ MHz}, A_{IN} = -1 \text{ dBFS}$		85		92		
		$f_{IN} = 190 \text{ MHz}, A_{IN} = -3 \text{ dBFS}$		86		91		
		$f_{IN} = 300 \text{ MHz}$		81		89		
		$f_{IN} = 350 \text{ MHz}$		79		82		
		$f_{IN} = 370 \text{ MHz}$		78				
		$f_{IN} = 470 \text{ MHz}$		72		73		
IMD3	Two-tone, third-order intermodulation distortion	$f_{IN} = 185 \text{ MHz}, f_{IN} = 190 \text{ MHz}, A_{IN} = -7 \text{ dBFS}$		89				dBFS
		$f_{IN} = 365 \text{ MHz}, f_{IN} = 370 \text{ MHz}, A_{IN} = -7 \text{ dBFS}$		82				
		$f_{IN} = 465 \text{ MHz}, f_{IN} = 470 \text{ MHz}, A_{IN} = -7 \text{ dBFS}$		77				

6.7 Digital Characteristics

typical values are at $T_A = 25^\circ\text{C}$, full temperature range is from $T_{\text{MIN}} = -40^\circ\text{C}$ to $T_{\text{MAX}} = 85^\circ\text{C}$, ADC sampling rate = 500 MSPS, 50% clock duty cycle, AVDD3V = 3 V, AVDD = DVDD = 1.9 V, IOVDD = 1.15 V, and -1-dBFS differential input (unless otherwise noted)

PARAMETER		TEST CONDITIONS	MIN	TYP	MAX	UNIT
DIGITAL INPUTS (RESET, SCLK, SEN, SDIN, PDN)⁽¹⁾						
V_{IH}	High-level input voltage	All digital inputs support 1.2-V and 1.8-V logic levels	0.8			V
V_{IL}	Low-level input voltage	All digital inputs support 1.2-V and 1.8-V logic levels			0.4	V
I_{IH}	High-level input current	SEN		0		μA
		RESET, SCLK, SDIN, PDN		100		
I_{IL}	Low-level input current	SEN		50		μA
		RESET, SCLK, SDIN, PDN		0		
DIGITAL INPUTS (SYSREFP, SYSREFM, SYNCbABM, SYNCbABP, SYNCbCDM, SYNCbCDP)						
V_{D}	Differential input voltage		0.35	0.45	1.4	V
$V_{\text{(CM_DIG)}}$	Common-mode voltage for SYSREF			1.3		V
DIGITAL OUTPUTS (SDOUT, PDN)						
V_{OH}	High-level output voltage		$\text{DVDD} - 0.1$	DVDD		V
V_{OL}	Low-level output voltage				0.1	V
DIGITAL OUTPUTS (JESD204B Interface: DxP, DxM)⁽²⁾						
V_{OD}	Output differential voltage	With default swing setting		700		mV_{PP}
V_{OC}	Output common-mode voltage			450		mV
	Transmitter short-circuit current	Transmitter pins shorted to any voltage between -0.25 V and 1.45 V	-100		100	mA
Z_{os}	Single-ended output impedance			50		Ω
	Output capacitance	Output capacitance inside the device, from either output to ground		2		pF

- (1) The RESET, SCLK, SDATA, and PDN pins have a 20-k Ω (typical) internal pulldown resistor to ground, and the SEN pin has a 20-k Ω (typical) pull up resistor to IOVDD.
 (2) 50- Ω , single-ended external termination to IOVDD.

6.8 Timing Characteristics

typical values are at $T_A = 25^\circ\text{C}$, full temperature range is from $T_{\text{MIN}} = -40^\circ\text{C}$ to $T_{\text{MAX}} = 85^\circ\text{C}$, ADC sampling rate = 500 MSPS, 50% clock duty cycle, AVDD3V = 3 V, AVDD = DVDD = 1.9 V, IOVDD = 1.15 V, and -1-dBFS differential input (unless otherwise noted)

	MIN	TYP	MAX	UNIT
SAMPLE TIMING CHARACTERISTICS				
Aperture delay	0.75		1.6	ns
Aperture delay matching between two channels on the same device		± 70		ps
Aperture delay matching between two devices at the same temperature and supply voltage		± 270		ps
Aperture jitter		135		f_s rms
Wake-up time to valid data after coming out of global power-down		150		μs
Data latency ⁽¹⁾ : ADC sample to digital output		77		Input clock cycles
OVR latency: ADC sample to OVR bit		44		Input clock cycles
t_{PDI} Clock propagation delay: input clock rising edge cross-over to output clock rising edge cross-over		4		ns
$t_{\text{SU_SYSREF}}$ Setup time for SYSREF, referenced to input clock rising edge	300		900	ps
$t_{\text{H_SYSREF}}$ Hold time for SYSREF, referenced to input clock rising edge	100			ps
JESD OUTPUT INTERFACE TIMING CHARACTERISTICS				
Unit interval	100		400	ps
Serial output data rate	2.5		10	Gbps
Total jitter for BER of 1E-15 and lane rate = 10 Gbps		26		ps
Random jitter for BER of 1E-15 and lane rate = 10 Gbps		0.75		ps rms
Deterministic jitter for BER of 1E-15 and lane rate = 10 Gbps		12		ps, pk-pk
$t_{\text{R}}, t_{\text{F}}$ Data rise time, data fall time: rise and fall times measured from 20% to 80%, differential output waveform, 2.5 Gbps \leq bit rate \leq 10 Gbps		35		ps

(1) Overall ADC latency = data latency + t_{PDI} .

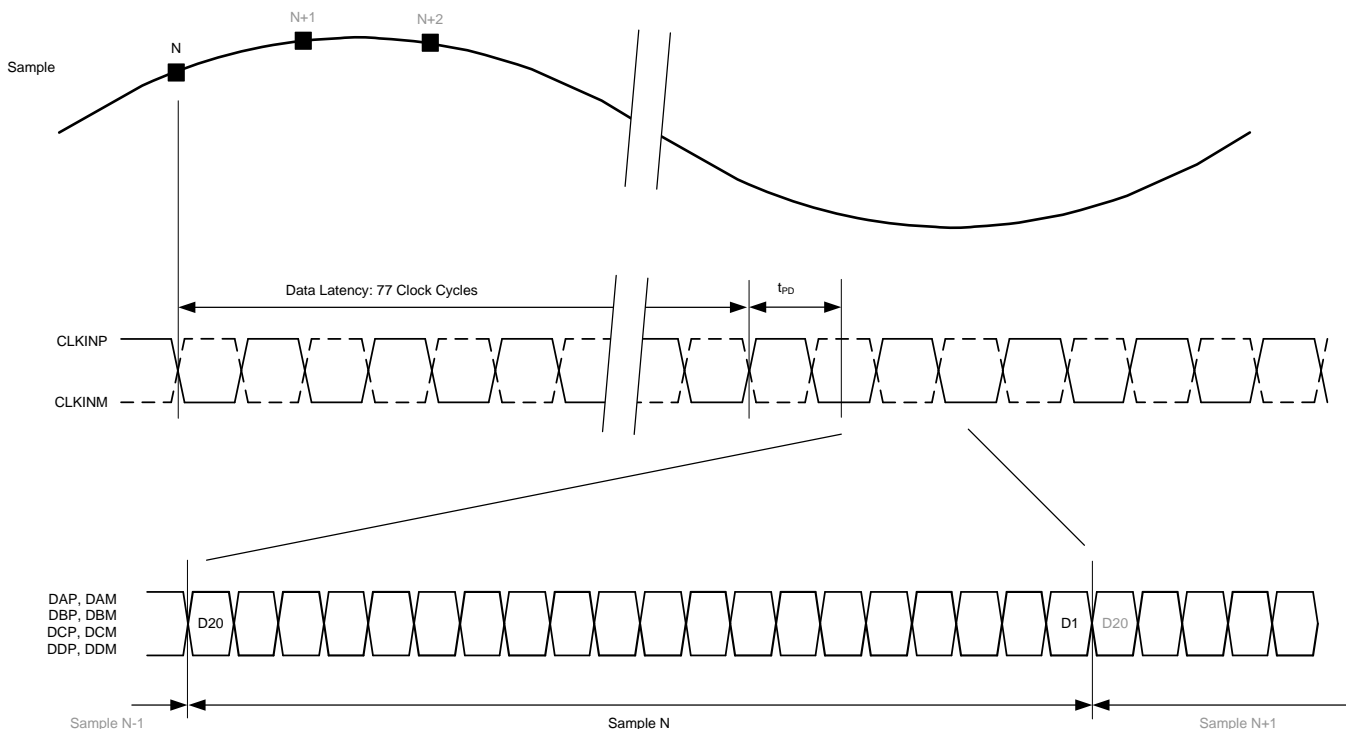

Figure 1. Latency Timing Diagram

6.9 Typical Characteristics: General (DDC Mode-8)

typical values are at $T_A = 25^\circ\text{C}$, full temperature range is from $T_{\text{MIN}} = -40^\circ\text{C}$ to $T_{\text{MAX}} = 85^\circ\text{C}$, ADC sampling frequency = 500 MSPS, 14-bit resolution, no decimation filter, 50% clock duty cycle, $\text{AVDD3V} = 3\text{ V}$, $\text{AVDD} = \text{DVDD} = 1.9\text{ V}$, $\text{IOVDD} = 1.15\text{ V}$, -1-dBFS differential input for $\text{IF} \leq 250\text{ MHz}$, and -3-dBFS differential input for $\text{IF} > 250\text{ MHz}$ (unless otherwise noted)

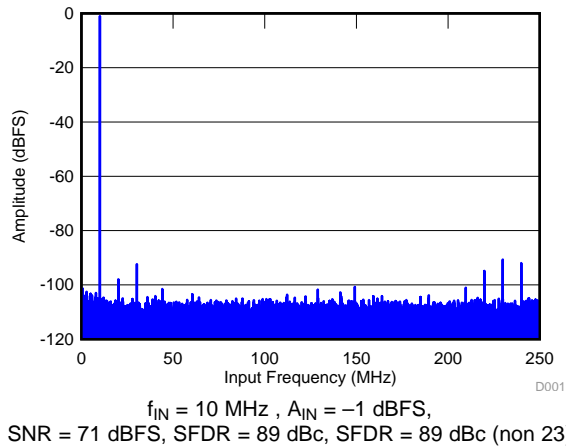

Figure 2. FFT for 10-MHz Input Signal

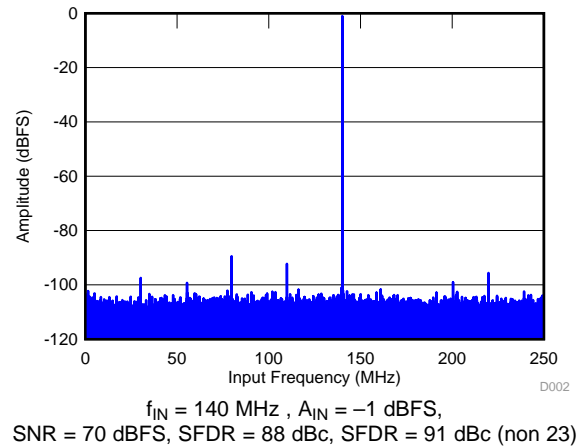

Figure 3. FFT for 140-MHz Input Signal

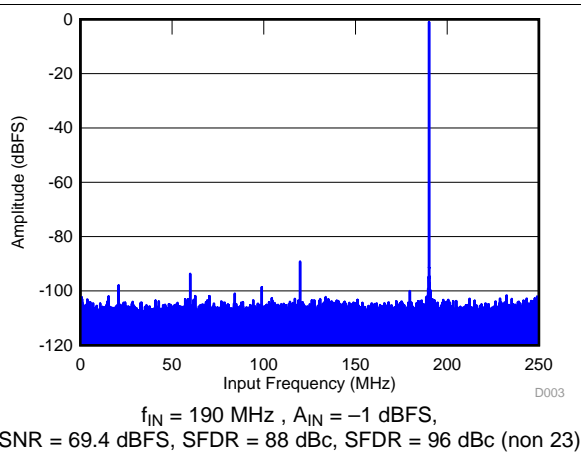

Figure 4. FFT for 190-MHz Input Signal

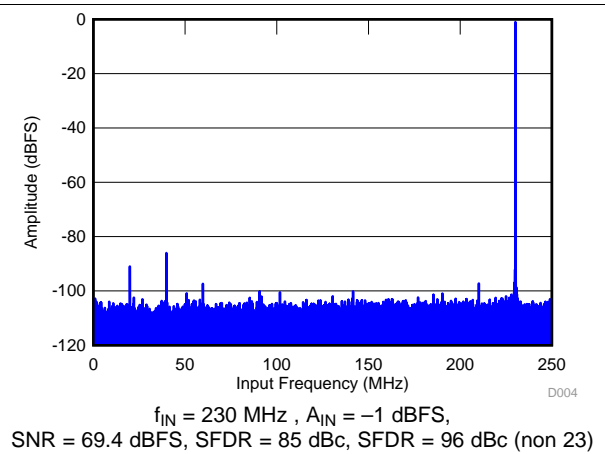

Figure 5. FFT for 230-MHz Input Signal

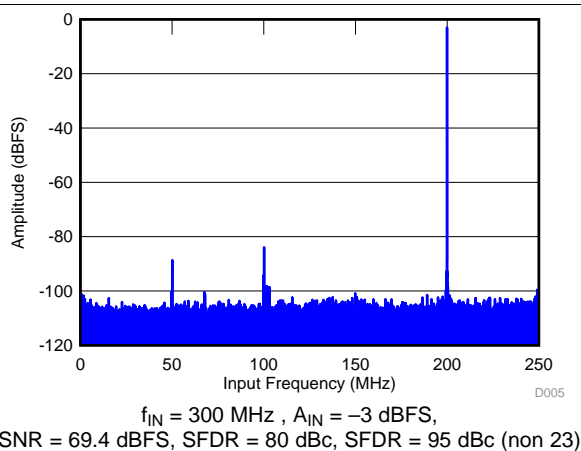

Figure 6. FFT for 300-MHz Input Signal

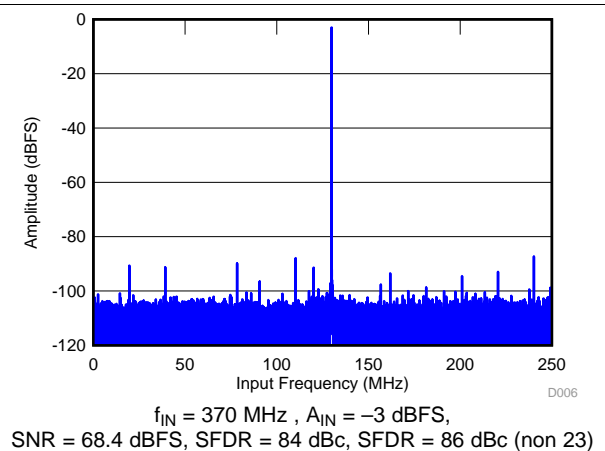
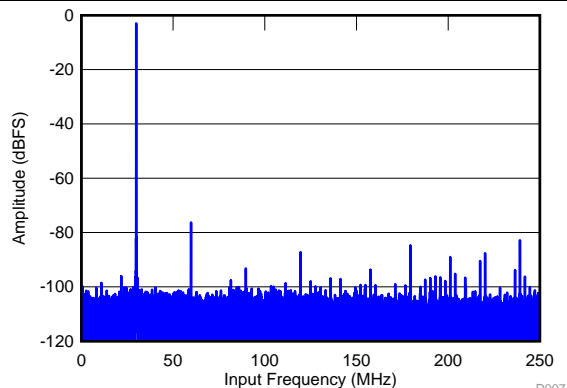

Figure 7. FFT for 370-MHz Input Signal

Typical Characteristics: General (DDC Mode-8) (continued)

typical values are at $T_A = 25^\circ\text{C}$, full temperature range is from $T_{\text{MIN}} = -40^\circ\text{C}$ to $T_{\text{MAX}} = 85^\circ\text{C}$, ADC sampling frequency = 500 MSPS, 14-bit resolution, no decimation filter, 50% clock duty cycle, $\text{AVDD3V} = 3\text{ V}$, $\text{AVDD} = \text{DVDD} = 1.9\text{ V}$, $\text{IOVDD} = 1.15\text{ V}$, -1-dBFS differential input for $\text{IF} \leq 250\text{ MHz}$, and -3-dBFS differential input for $\text{IF} > 250\text{ MHz}$ (unless otherwise noted)



$f_{\text{IN}} = 470\text{ MHz}$, $A_{\text{IN}} = -3\text{ dBFS}$,
SNR = 67.4 dBFS, SFDR = 73 dBc, SFDR = 80 dBc (non 23)

Figure 8. FFT for 470-MHz Input Signal

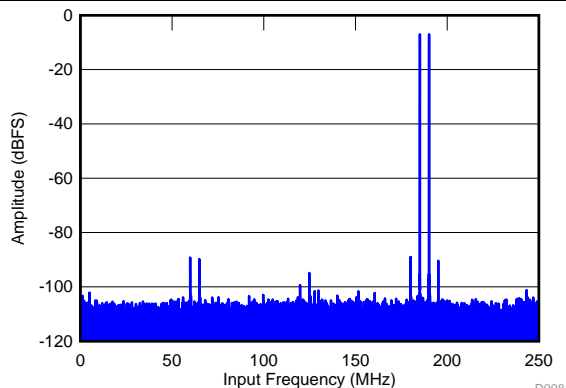

$f_{\text{IN1}} = 185\text{ MHz}$, $f_{\text{IN2}} = 190\text{ MHz}$, IMD = 89 dBFS,
each tone at -7 dBFS

Figure 9. FFT for Two-Tone Input Signal

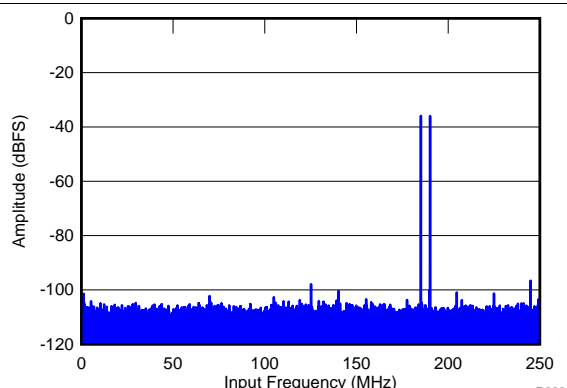

$f_{\text{IN1}} = 185\text{ MHz}$, $f_{\text{IN2}} = 190\text{ MHz}$, IMD = 103 dBFS,
each tone at -36 dBFS

Figure 10. FFT for Two-Tone Input Signal

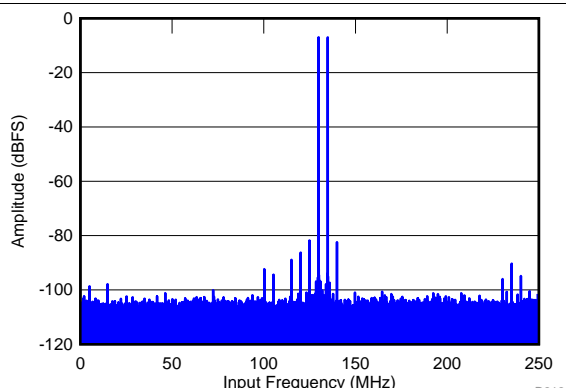

$f_{\text{IN1}} = 370\text{ MHz}$, $f_{\text{IN2}} = 365\text{ MHz}$, IMD = 81.7 dBFS,
each tone at -7 dBFS

Figure 11. FFT for Two-Tone Input Signal

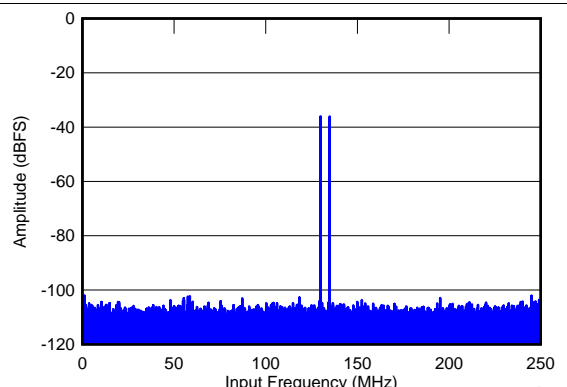

$f_{\text{IN1}} = 370\text{ MHz}$, $f_{\text{IN2}} = 365\text{ MHz}$, IMD = 102 dBFS,
each tone at -36 dBFS

Figure 12. FFT for Two-Tone Input Signal

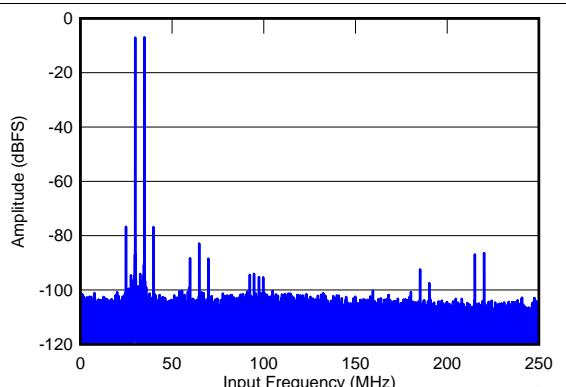

$f_{\text{IN1}} = 470\text{ MHz}$, $f_{\text{IN2}} = 465\text{ MHz}$, IMD = 76.7 dBFS,
each tone at -7 dBFS

Figure 13. FFT for Two-Tone Input Signal

Typical Characteristics: General (DDC Mode-8) (continued)

typical values are at $T_A = 25^\circ\text{C}$, full temperature range is from $T_{\text{MIN}} = -40^\circ\text{C}$ to $T_{\text{MAX}} = 85^\circ\text{C}$, ADC sampling frequency = 500 MSPS, 14-bit resolution, no decimation filter, 50% clock duty cycle, $\text{AVDD3V} = 3\text{ V}$, $\text{AVDD} = \text{DVDD} = 1.9\text{ V}$, $\text{IOVDD} = 1.15\text{ V}$, -1-dBFS differential input for $\text{IF} \leq 250\text{ MHz}$, and -3-dBFS differential input for $\text{IF} > 250\text{ MHz}$ (unless otherwise noted)

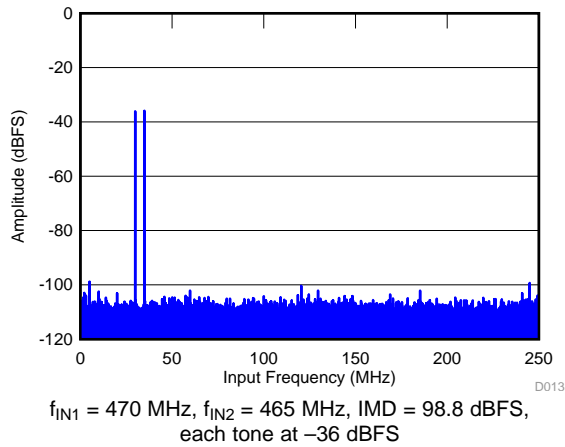

Figure 14. FFT for Two-Tone Input Signal

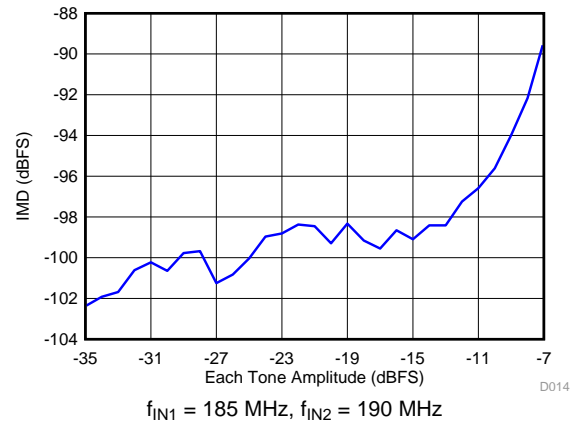

Figure 15. Intermodulation Distortion vs Input Amplitude

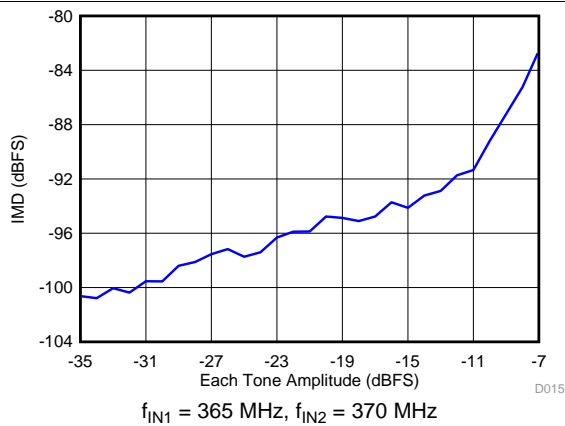

Figure 16. Intermodulation Distortion vs Input Amplitude

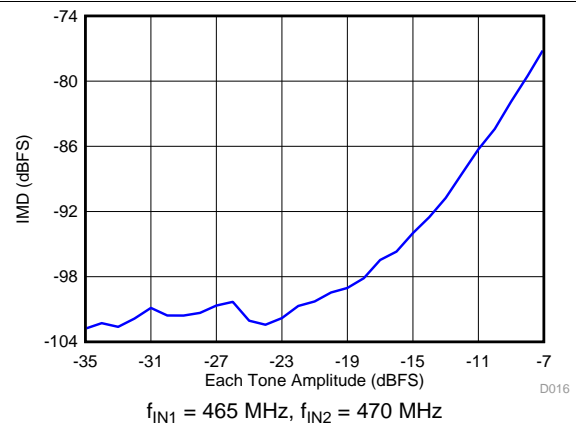

Figure 17. Intermodulation Distortion vs Input Amplitude

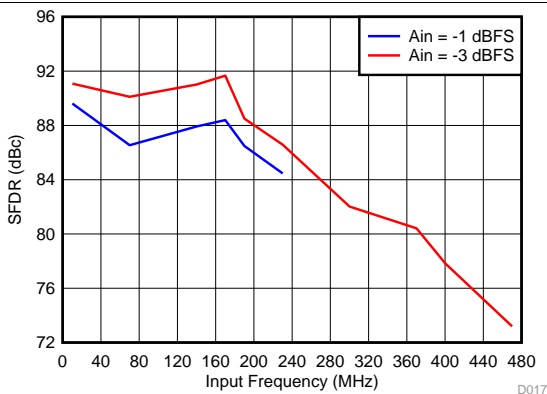

Figure 18. Spurious-Free Dynamic Range vs Input Frequency

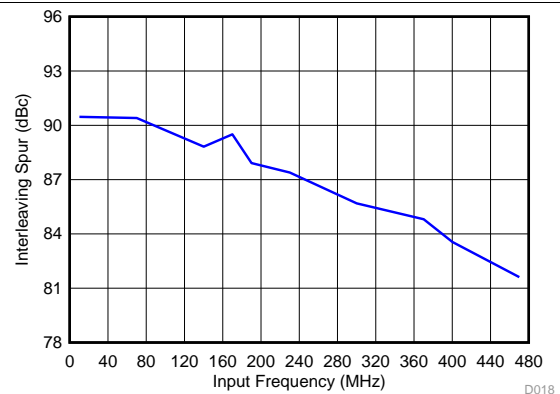

Figure 19. IL Spur vs Input Frequency

Typical Characteristics: General (DDC Mode-8) (continued)

typical values are at $T_A = 25^\circ\text{C}$, full temperature range is from $T_{\text{MIN}} = -40^\circ\text{C}$ to $T_{\text{MAX}} = 85^\circ\text{C}$, ADC sampling frequency = 500 MSPS, 14-bit resolution, no decimation filter, 50% clock duty cycle, AVDD3V = 3 V, AVDD = DVDD = 1.9 V, IOVDD = 1.15 V, -1-dBFS differential input for $f_{\text{IN}} \leq 250$ MHz, and -3-dBFS differential input for $f_{\text{IN}} > 250$ MHz (unless otherwise noted)

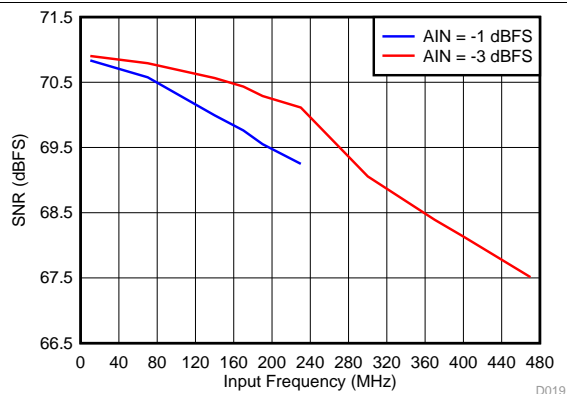
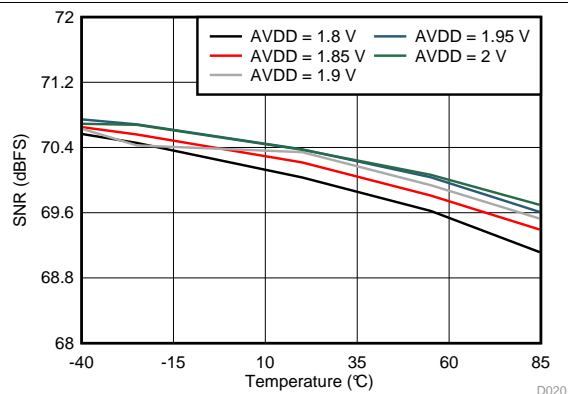
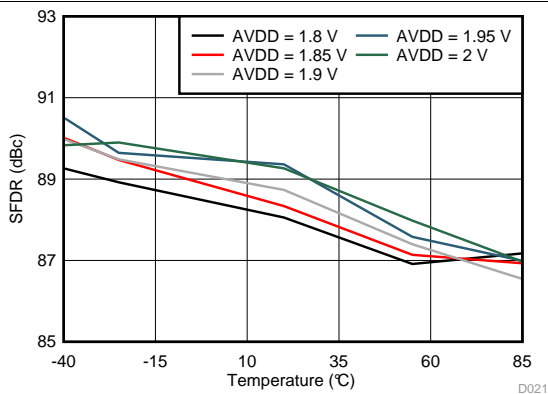

Figure 20. Signal-to-Noise Ratio vs Input Frequency



$f_{\text{IN}} = 190$ MHz, $A_{\text{IN}} = -1$ dBFS

Figure 21. Signal-to-Noise Ratio vs AVDD Supply and Temperature



$f_{\text{IN}} = 190$ MHz, $A_{\text{IN}} = -1$ dBFS

Figure 22. Spurious-Free Dynamic Range vs AVDD Supply and Temperature

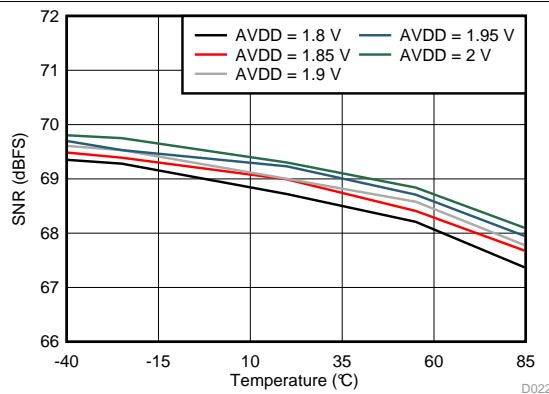

$f_{\text{IN}} = 370$ MHz, $A_{\text{IN}} = -3$ dBFS

Figure 23. Signal-to-Noise Ratio vs AVDD Supply and Temperature

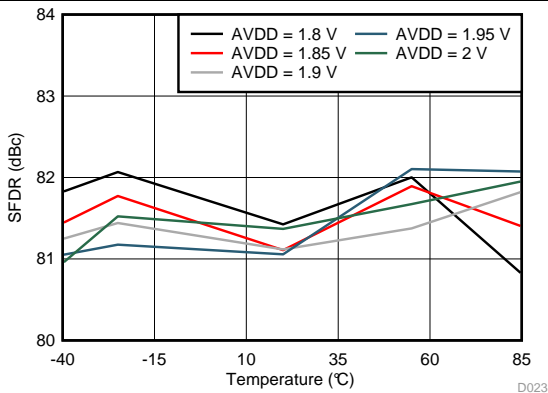

$f_{\text{IN}} = 370$ MHz, $A_{\text{IN}} = -3$ dBFS

Figure 24. Spurious-Free Dynamic Range vs AVDD Supply and Temperature

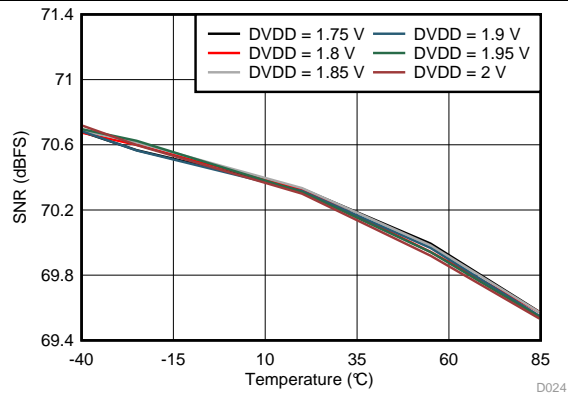

$f_{\text{IN}} = 190$ MHz, $A_{\text{IN}} = -1$ dBFS

Figure 25. Signal-to-Noise Ratio vs DVDD Supply and Temperature

Typical Characteristics: General (DDC Mode-8) (continued)

typical values are at $T_A = 25^\circ\text{C}$, full temperature range is from $T_{\text{MIN}} = -40^\circ\text{C}$ to $T_{\text{MAX}} = 85^\circ\text{C}$, ADC sampling frequency = 500 MSPS, 14-bit resolution, no decimation filter, 50% clock duty cycle, AVDD3V = 3 V, AVDD = DVDD = 1.9 V, IOVDD = 1.15 V, -1-dBFS differential input for $f_{\text{IN}} \leq 250$ MHz, and -3-dBFS differential input for $f_{\text{IN}} > 250$ MHz (unless otherwise noted)

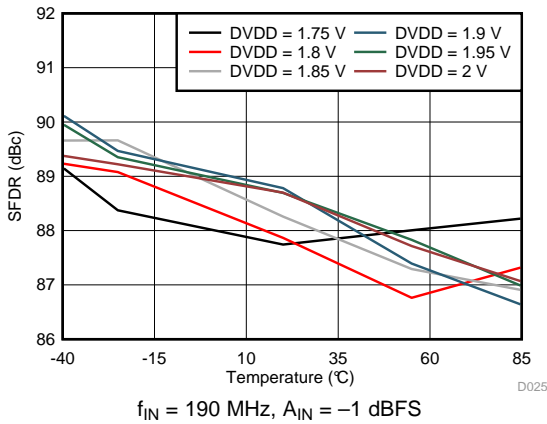

Figure 26. Spurious-Free Dynamic Range vs DVDD Supply and Temperature

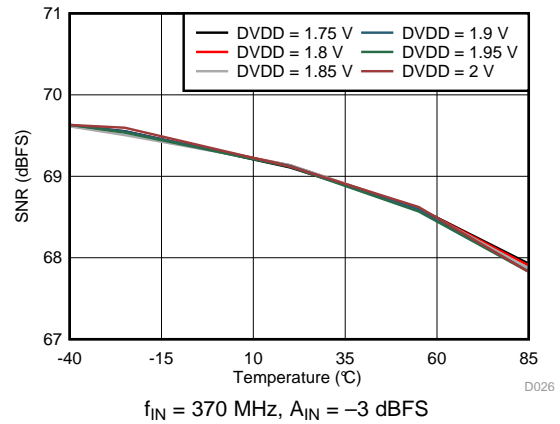

Figure 27. Signal-to-Noise Ratio vs DVDD Supply and Temperature

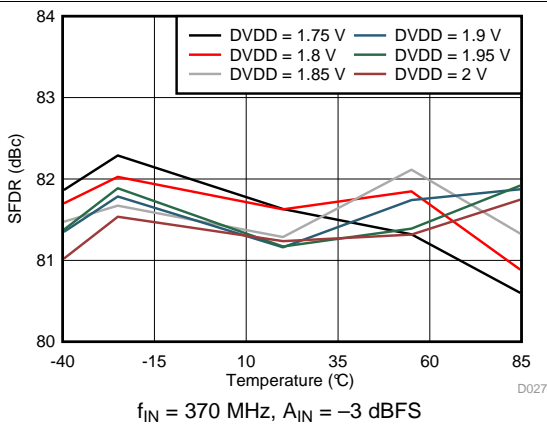

Figure 28. Spurious-Free Dynamic Range vs DVDD Supply and Temperature

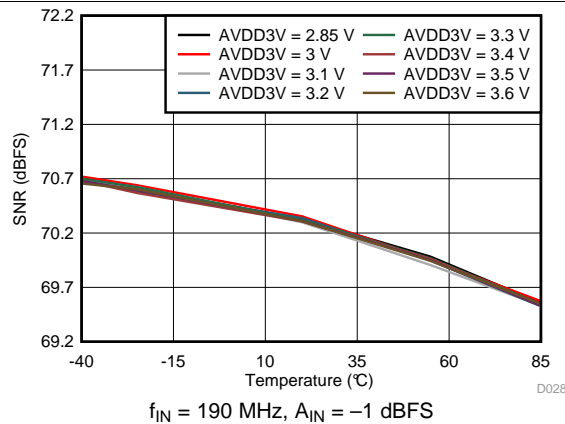

Figure 29. Signal-to-Noise Ratio vs AVDD3V Supply and Temperature

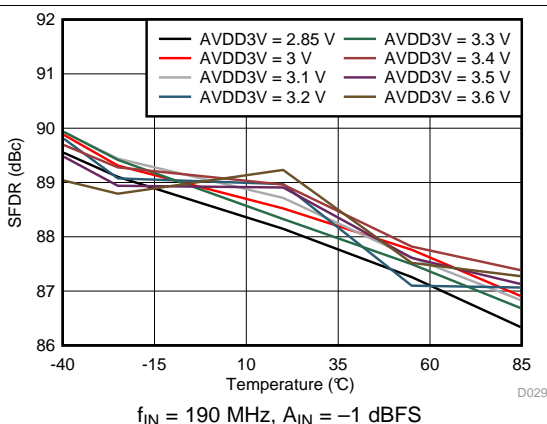

Figure 30. Spurious-Free Dynamic Range vs AVDD3V Supply and Temperature

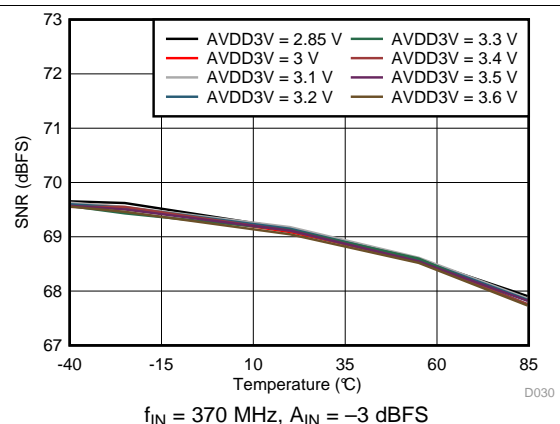

Figure 31. Signal-to-Noise Ratio vs AVDD3V Supply and Temperature

Typical Characteristics: General (DDC Mode-8) (continued)

typical values are at $T_A = 25^\circ\text{C}$, full temperature range is from $T_{\text{MIN}} = -40^\circ\text{C}$ to $T_{\text{MAX}} = 85^\circ\text{C}$, ADC sampling frequency = 500 MSPS, 14-bit resolution, no decimation filter, 50% clock duty cycle, AVDD3V = 3 V, AVDD = DVDD = 1.9 V, IOVDD = 1.15 V, -1-dBFS differential input for $f_{\text{IN}} \leq 250$ MHz, and -3-dBFS differential input for $f_{\text{IN}} > 250$ MHz (unless otherwise noted)

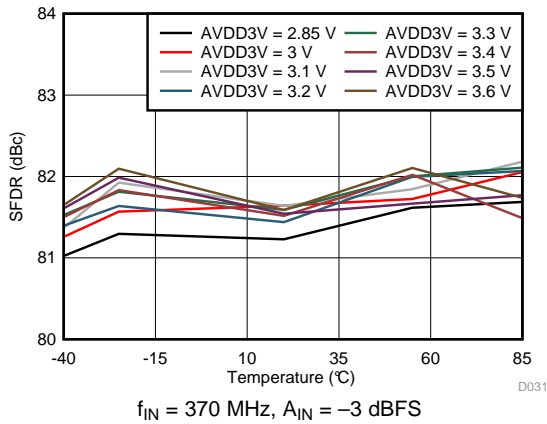

Figure 32. Spurious-Free Dynamic Range vs AVDD3V Supply and Temperature

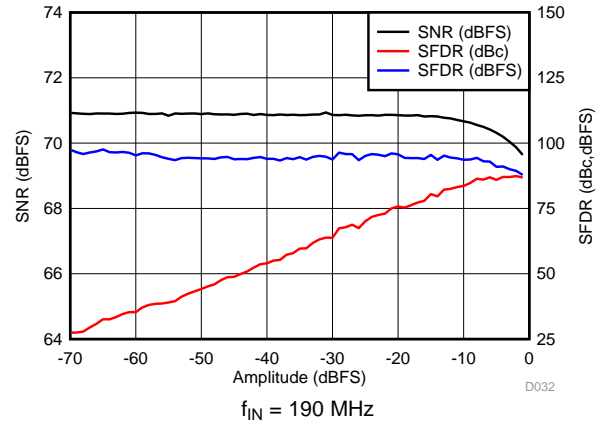

Figure 33. Performance vs Amplitude

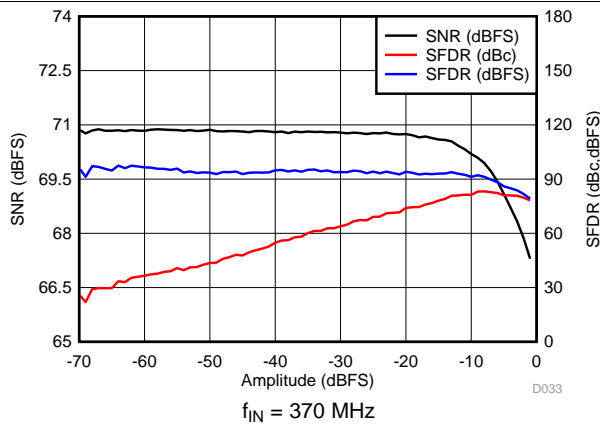

Figure 34. Performance vs Amplitude

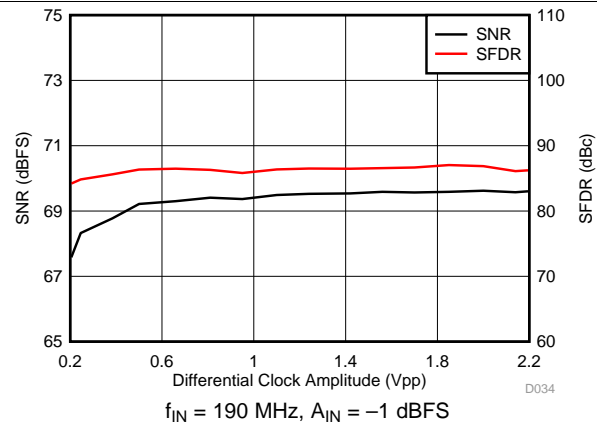

Figure 35. Performance vs Clock Amplitude

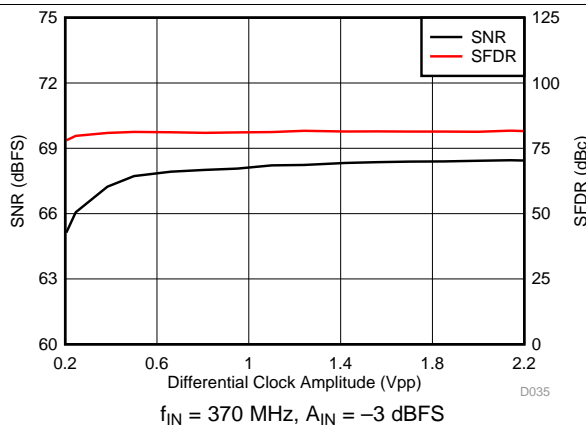

Figure 36. Performance vs Clock Amplitude

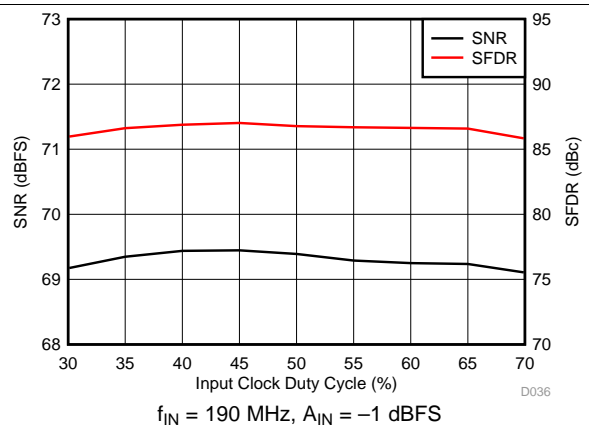

Figure 37. Performance vs Clock Duty Cycle

Typical Characteristics: General (DDC Mode-8) (continued)

typical values are at $T_A = 25^\circ\text{C}$, full temperature range is from $T_{\text{MIN}} = -40^\circ\text{C}$ to $T_{\text{MAX}} = 85^\circ\text{C}$, ADC sampling frequency = 500 MSPS, 14-bit resolution, no decimation filter, 50% clock duty cycle, AVDD3V = 3 V, AVDD = DVDD = 1.9 V, IOVDD = 1.15 V, -1-dBFS differential input for $f_{\text{IN}} \leq 250$ MHz, and -3-dBFS differential input for $f_{\text{IN}} > 250$ MHz (unless otherwise noted)

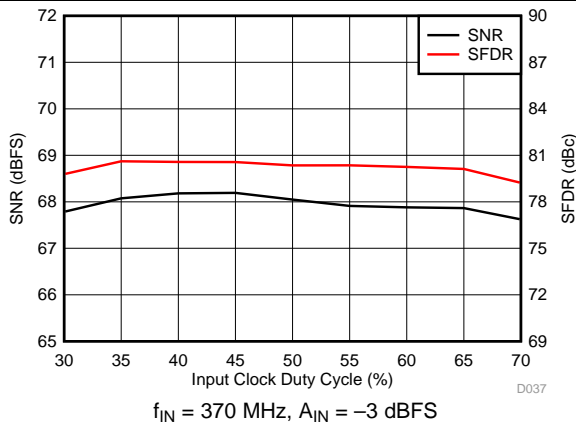

Figure 38. Performance vs Clock Duty Cycle

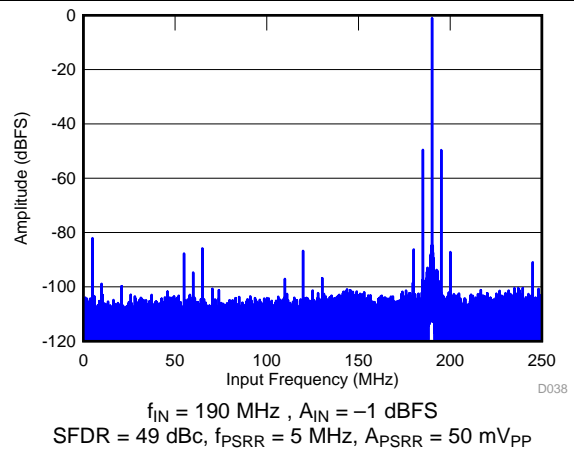

Figure 39. Power-Supply Rejection Ratio FFT for Test Signal on AVDD Supply

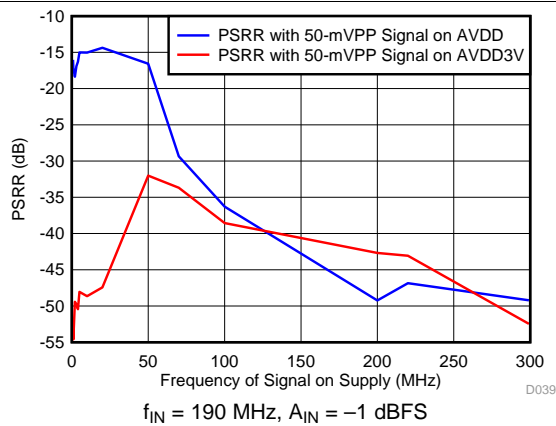

Figure 40. Power-Supply Rejection Ratio vs Supplies

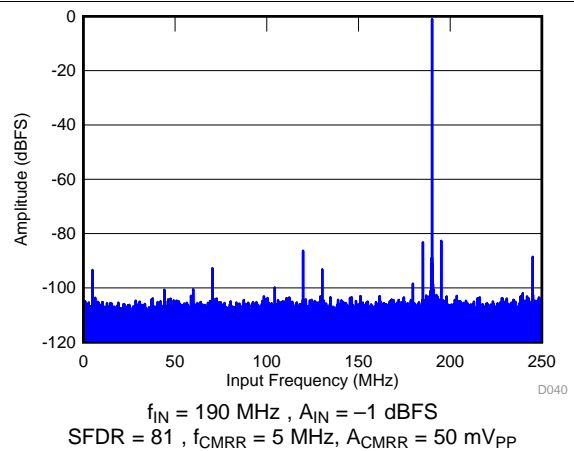

Figure 41. Common-Mode Rejection Ratio FFT

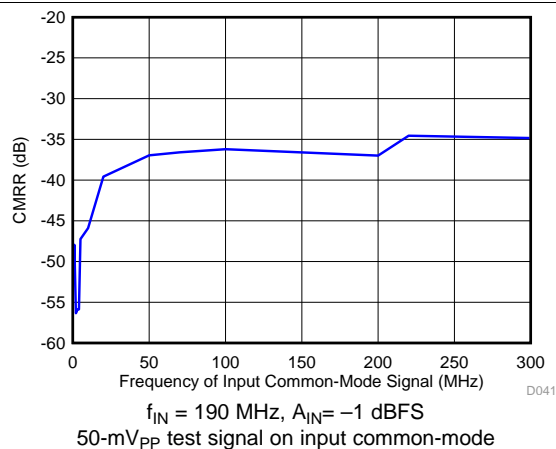

Figure 42. Common-Mode Rejection Ratio

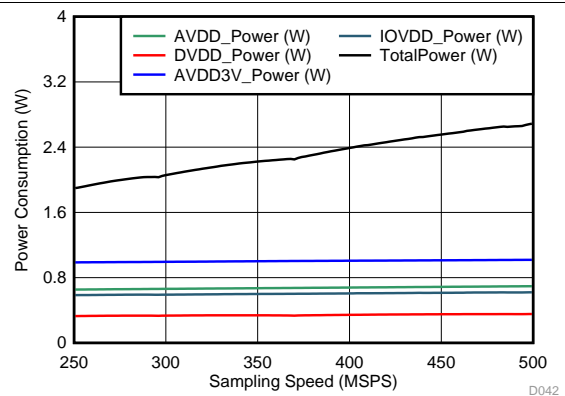
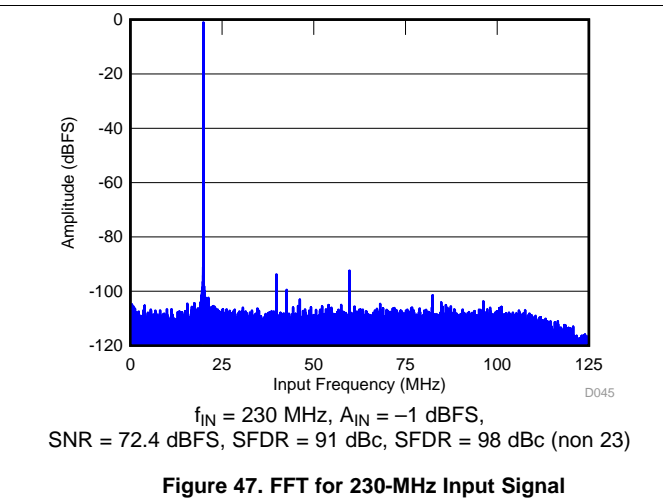
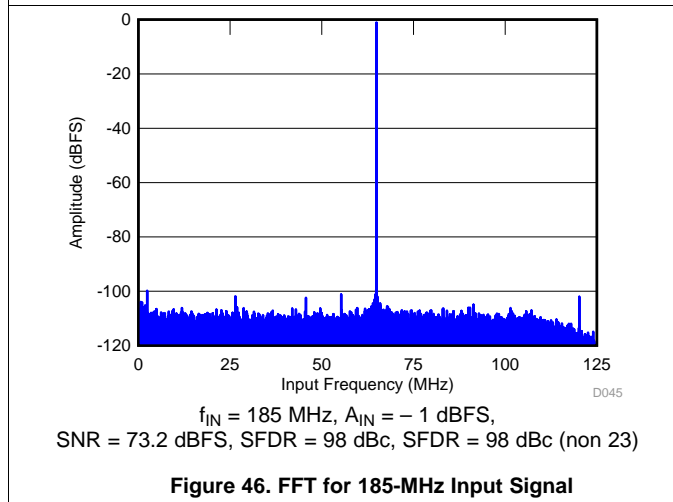
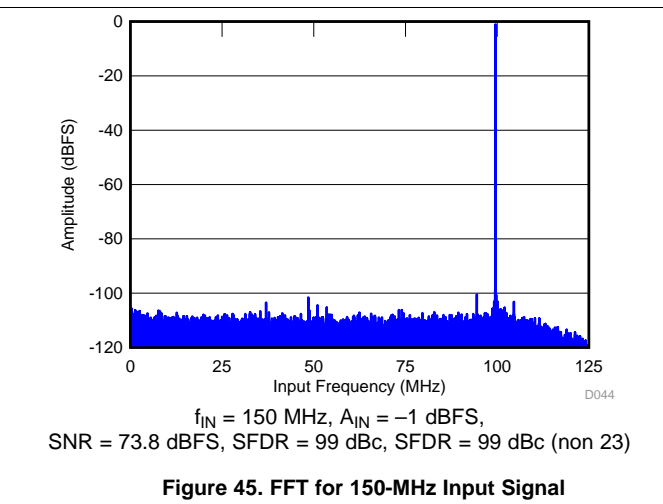
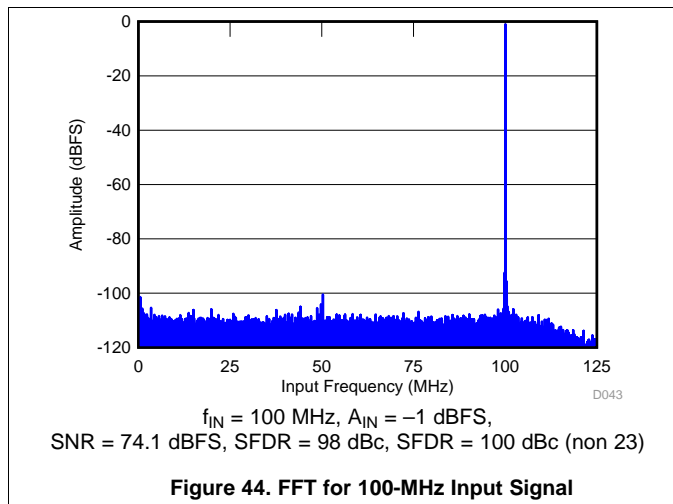

Figure 43. Power vs Chip Clock

6.10 Typical Characteristics: Mode 2

low-pass or high-pass decimation-by-2 filter selected as per input frequency; typical values are at $T_A = 25^\circ\text{C}$, full temperature range is from $T_{\text{MIN}} = -40^\circ\text{C}$ to $T_{\text{MAX}} = 85^\circ\text{C}$, ADC sampling frequency = 500 MSPS, 14-bit resolution, no decimation filter, 50% clock duty cycle, $AVDD3V = 3\text{ V}$, $AVDD = DVDD = 1.9\text{ V}$, $IOVDD = 1.15\text{ V}$, -1-dBFS differential input for $IF \leq 250\text{ MHz}$, and -3-dBFS differential input for $IF > 250\text{ MHz}$ (unless otherwise noted)



6.11 Typical Characteristics: Mode 0

low-pass decimation-by-2 filter selected, complex FFT plotted, mixer frequency 125 MHz; typical values are at $T_A = 25^\circ\text{C}$, full temperature range is from $T_{\text{MIN}} = -40^\circ\text{C}$ to $T_{\text{MAX}} = 85^\circ\text{C}$, ADC sampling frequency = 500 MSPS, 14-bit resolution, no decimation filter, 50% clock duty cycle, $\text{AVDD3V} = 3\text{ V}$, $\text{AVDD} = \text{DVDD} = 1.9\text{ V}$, $\text{IOVDD} = 1.15\text{ V}$, -1-dBFS differential input for $\text{IF} \leq 250\text{ MHz}$, and -3-dBFS differential input for $\text{IF} > 250\text{ MHz}$ (unless otherwise noted)

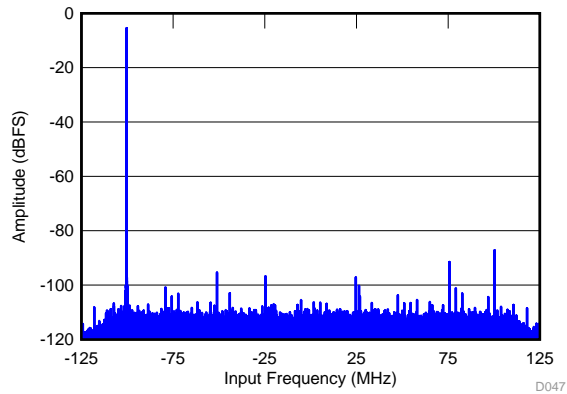

$f_{\text{IN}} = 270\text{ MHz}$, $A_{\text{IN}} = -3\text{ dBFS}$,
SNR = 69.5 dBFS, SFDR = 83 dBc, SFDR = 87 dBc (non 23)

Figure 48. FFT for 270-MHz Input Signal

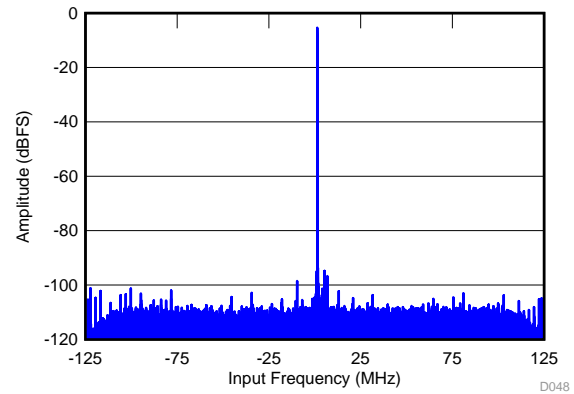

$f_{\text{IN}} = 370\text{ MHz}$, $A_{\text{IN}} = -3\text{ dBFS}$,
SNR = 68.1 dBFS, SFDR = 82 dBc, SFDR = 82 dBc (non 23)

Figure 49. FFT for 370-MHz Input Signal

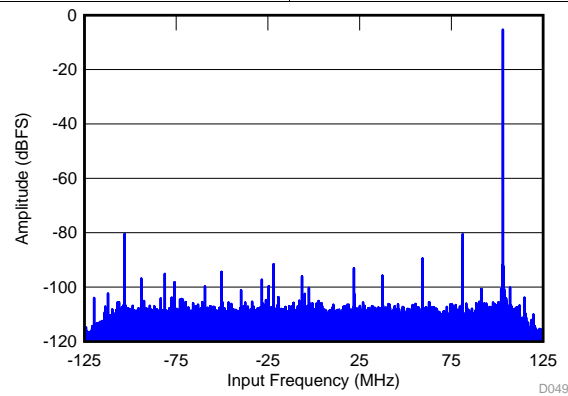

$f_{\text{IN}} = 470\text{ MHz}$, $A_{\text{IN}} = -3\text{ dBFS}$,
SNR = 66.3 dBFS, SFDR = 75 dBc, SFDR = 75 dBc (non 23)

Figure 50. FFT for 470-MHz Input Signal

7 Detailed Description

7.1 Overview

The ADS54J66 is a low-power, wide-bandwidth, 14-bit, 500-MSPS, quad-channel, telecom receiver device. The ADS54J66 supports the JESD204B serial interface with data rates up to 10 Gbps supporting one lane per channel. The buffered analog input provides uniform input impedance across a wide frequency range and minimizes sample-and-hold glitch energy. The ADS54J66 provides excellent spurious-free dynamic range (SFDR) over a large input frequency range with very low power consumption. The device digital block includes a 2x and 4x decimation low-pass filter with $f_s / 4$ and $k \times f_s / 16$ mixers to support a receive bandwidth up to 200 MHz for use as a Digital Pre-Distortion (DPD) observation receiver.

The JESD204B interface reduces the number of interface lines allowing high system integration density. An internal phase locked loop (PLL) multiplies the incoming ADC sampling clock to derive the bit clock which is used to serialize the 14-bit data from each channel.

7.2 Functional Block Diagram

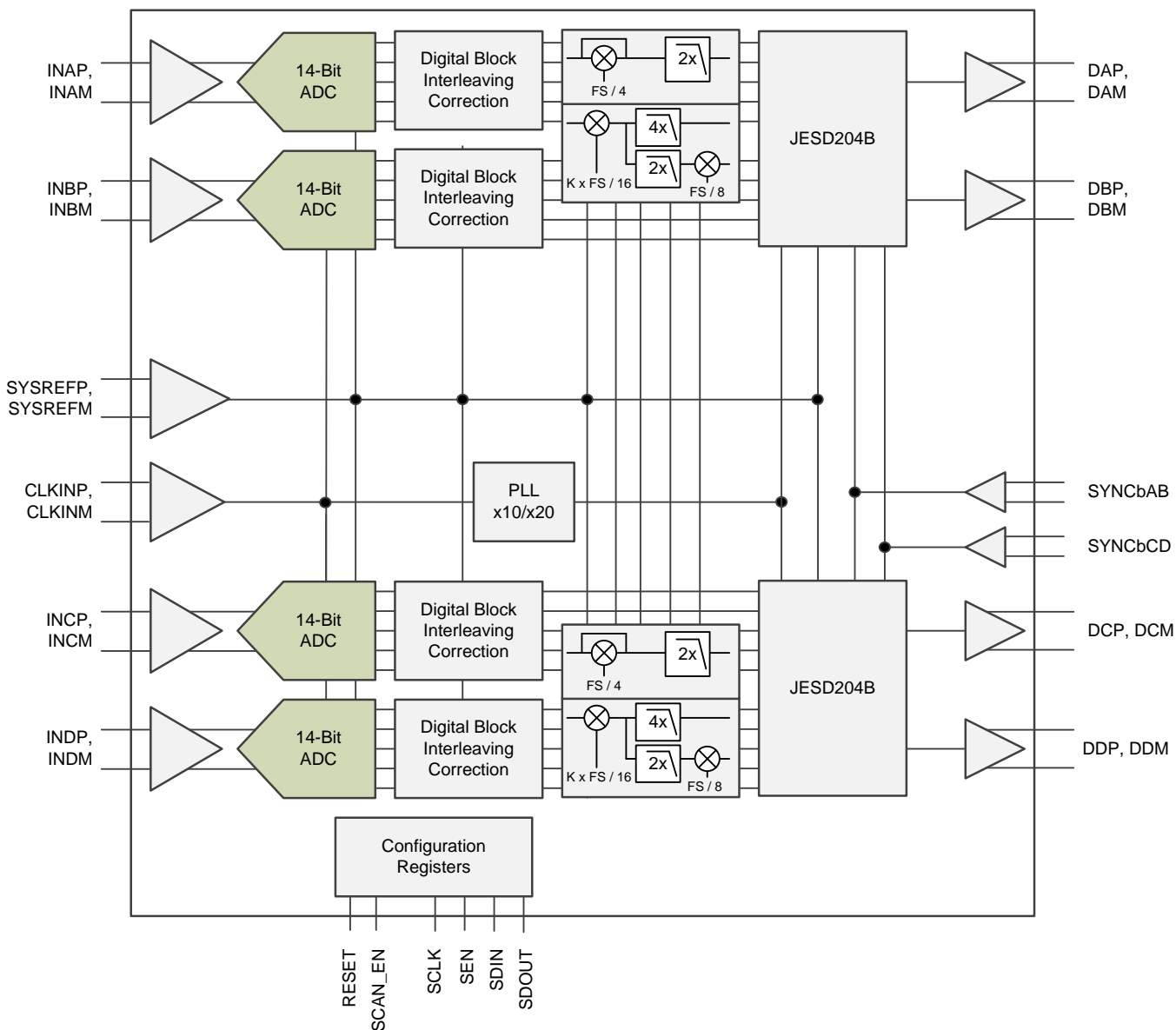

7.3 Feature Description

7.3.1 Analog Inputs

The ADS54J66 analog signal inputs are designed to be driven differentially. The analog input pins have internal analog buffers that drive the sampling circuit. As a result of the analog buffer, the input pins present a high impedance input across a very wide frequency range to the external driving source which enables great flexibility in the external analog filter design as well as excellent 50- Ω matching for RF applications. The buffer also helps isolate the external driving circuit from the internal switching currents of the sampling circuit, thus resulting in a more constant SFDR performance across input frequencies.

The common-mode voltage of the signal inputs is internally biased to 1.9 V using 600- Ω resistors which allows for ac coupling of the input drive network. Each input pin (INP, INM) must swing symmetrically between ($V_{CM} + 0.475$ V) and ($V_{CM} - 0.475$ V), resulting in a 1.9-V_{PP} (default) differential input swing. The input sampling circuit has a 3-dB bandwidth that extends up to 900 MHz.

7.3.2 Recommended Input Circuitry

In order to achieve optimum ac performance the circuitry shown in [Figure 51](#) is recommended at the analog inputs.

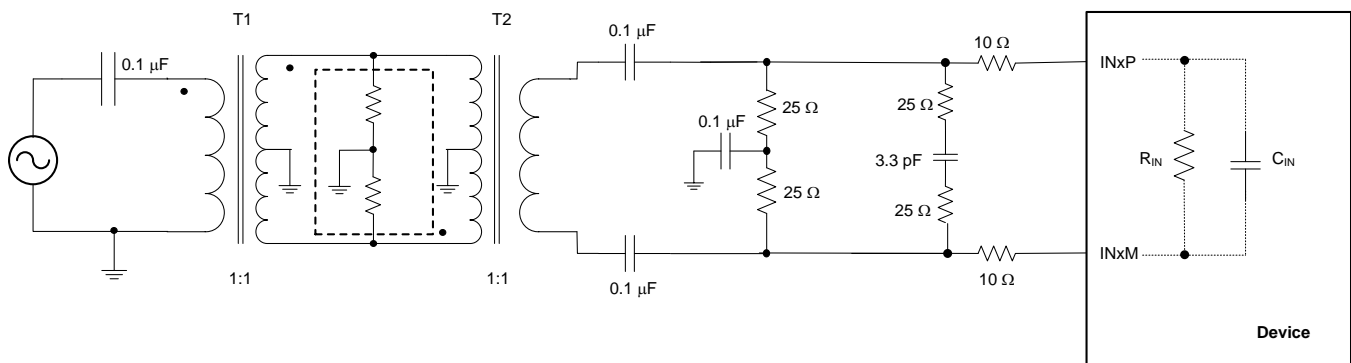

Figure 51. Analog Input Driving Circuit

7.4 Device Functional Modes

7.4.1 Digital Features

The ADS54J66 supports decimation-by-2 and -4 and un-decimated output. The four channels can be configured as pairs (A, B and C, D; however, the same decimation factor must be chosen for all four channels).

Figure 52 shows signal processing done in the digital down-conversion (DDC) block of the ADS54J66. Table 1 shows available modes of operation for this block.

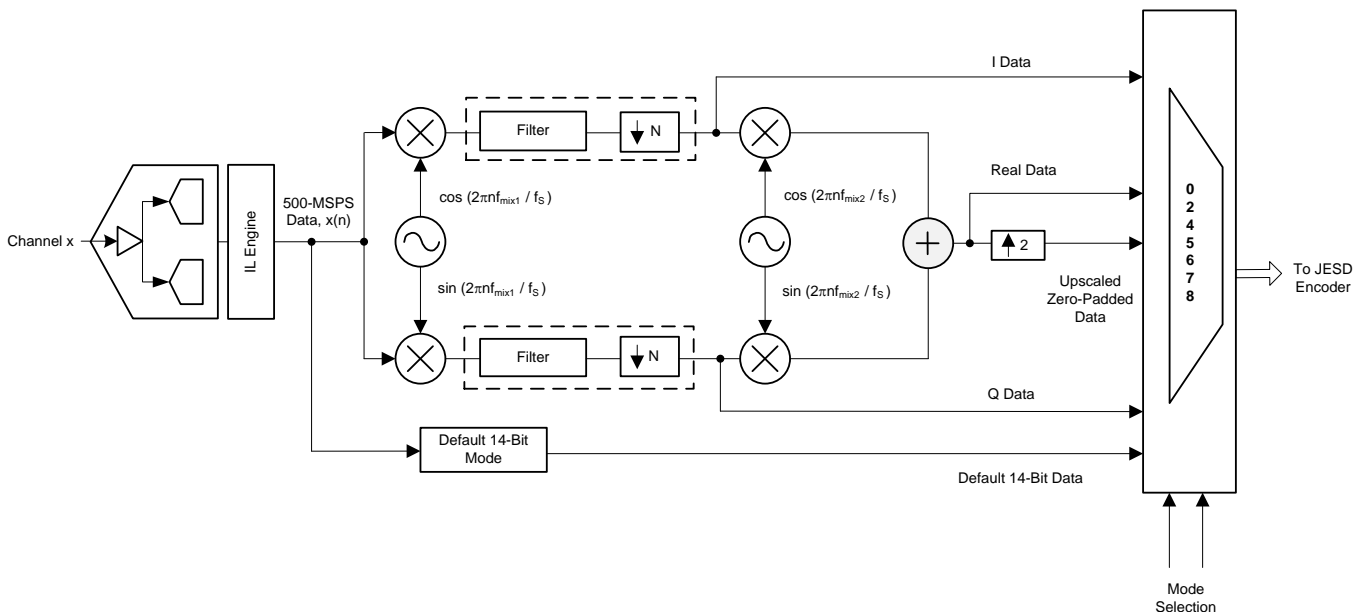

Figure 52. Digital Down-Conversion Block Diagram

Table 1. Overview of Operating Modes

OPERATING MODE	DESCRIPTION	DIGITAL MIXER	DECIMATION	BANDWIDTH		OUTPUT FORMAT	MAX OUTPUT RATE
				491 MSPS	368 MSPS		
0	Decimation	$\pm f_S / 4$	2	200 MHz	150 MHz	Complex	250 MSPS
2		–	2	100 MHz	75 MHz	Real	250 MSPS
4		$N \times f_S / 16$	2	100 MHz	75 MHz	Real	250 MSPS
5		$N \times f_S / 16$	2	200 MHz	150 MHz	Complex	250 MSPS
6		$N \times f_S / 16$	4	100 MHz	75 MHz	Complex	125 MSPS
7		$N \times f_S / 16$	2	100 MHz	75 MHz	Real	500 MSPS
8	No decimation	–	–	245.76 MHz	184.32 MHz	Real	500 MSPS

Table 2 shows characteristics of different blocks of DDC signal processing blocks active in different modes.

Table 2. Features of DDC Block in Different Modes

MODE	f_{mix1}	FILTER AND DECIMATION	f_{mix2}	OUTPUT
0	$f_S / 4$	LPF cutoff at $f_S / 4$, decimation-by-2	Not used	I, Q data at 250 MSPS each are given out
2	Not used	LPF or HPF cutoff at $f_S / 4$, decimation-by-2	Not used	Straight 250 MSPS data are given out
4	$k f_S / 16$	LPF cutoff at $f_S / 8$, decimation-by-2	$f_S / 8$	Real data at 250 MSPS are given out
5	$k f_S / 16$	LPF cutoff at $f_S / 8$, decimation-by-2	Not used	I, Q data at 250 MSPS each are given out
6	$k f_S / 16$	LPF cutoff at $f_S / 8$, decimation-by-4	Not used	I, Q data at 125 MSPS each are given out
7	$k f_S / 16$	LPF cutoff at $f_S / 8$, decimation-by-2	$f_S / 8$	Real data are up-scaled, zero-padded and given out at 500 MSPS
Default	Not used	Not used	Not used	Straight 500-MSPS, 14-bit data are given out

7.4.2 Mode 0, Decimation-by-2 with IQ Outputs for up to 220 MHz of IQ Bandwidth

In this configuration, the DDC block includes a fixed frequency $\pm f_s / 4$ complex digital mixer preceding the digital filter, so the IQ passband is approximately ± 110 MHz (3 dB) centered at $f_s / 4$. Mixing with $+f_s / 4$ inverts the spectrum. The stop-band attenuation is approximately 90 dB and the pass-band flatness is ± 0.1 dB. Figure 53 shows mixing operation in DDC mode 0. Table 3 shows corner frequencies of decimation filter in DDC mode 0. Figure 54 and Figure 55 show frequency response of the filter.

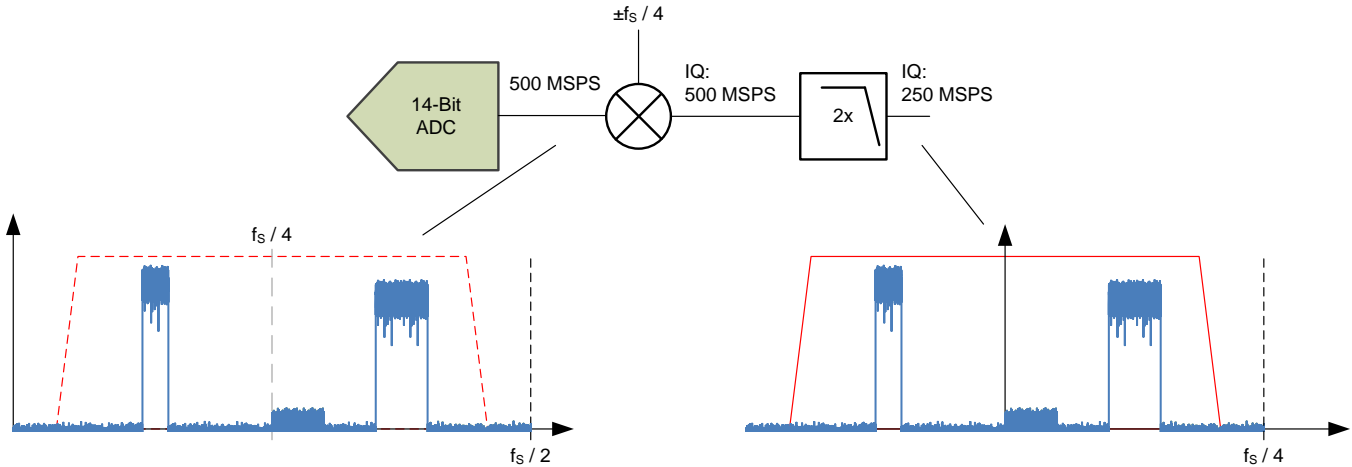
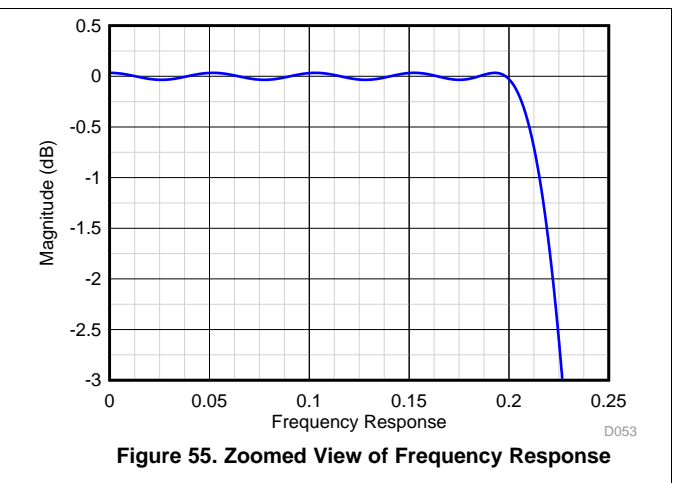
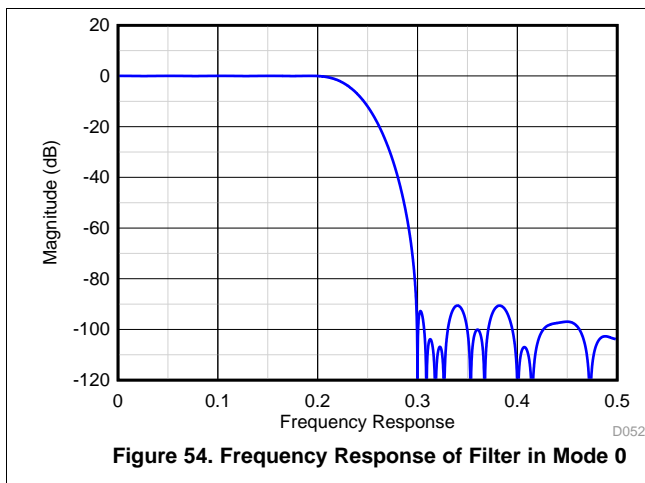

Figure 53. Mixing in Mode 0

Table 3. Filter Specification Details, Mode 0

CORNERS	LOW PASS
-0.1 dB	$0.204 \times f_s$
-0.5 dB	$0.211 \times f_s$
-1 dB	$0.216 \times f_s$
-3 dB	$0.226 \times f_s$



7.4.3 Mode 2, Decimation-by-2 for up to 110 MHz of Real Bandwidth

In this configuration, the DDC block only includes a 2x decimation filter (high pass or low pass) with real outputs. The pass band is approximately 110 MHz (3 dB). Figure 56 shows the filtering operation in DDC mode 2. Table 4 shows corner frequencies of decimation filter in DDC mode 2. Figure 57 and Figure 58 show frequency response of the filter.

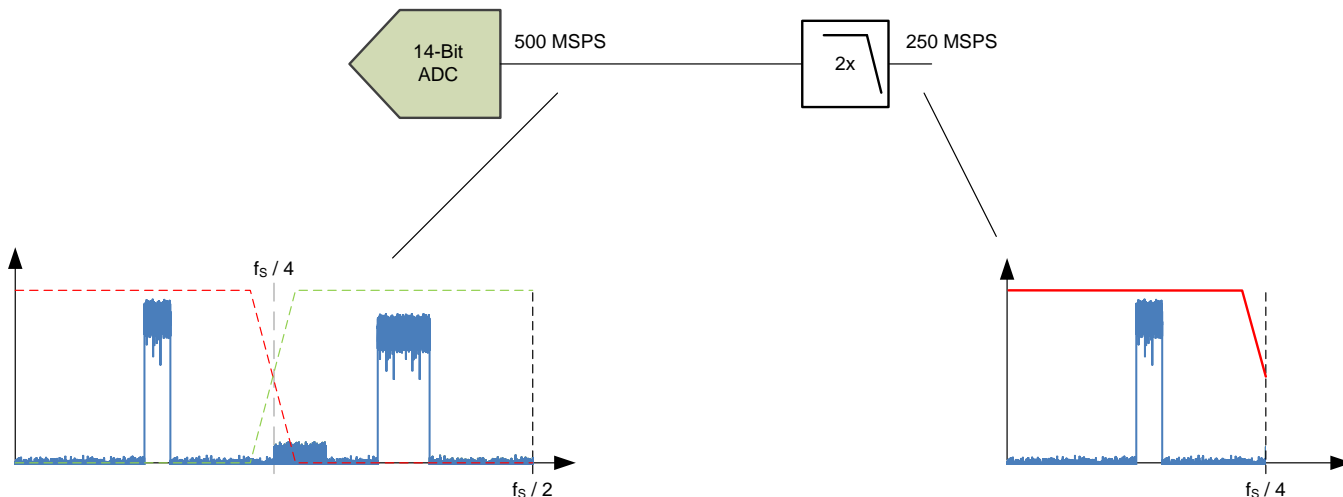
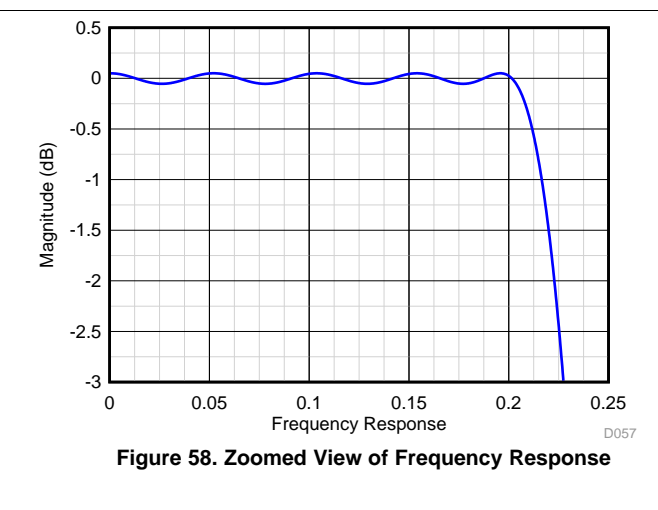
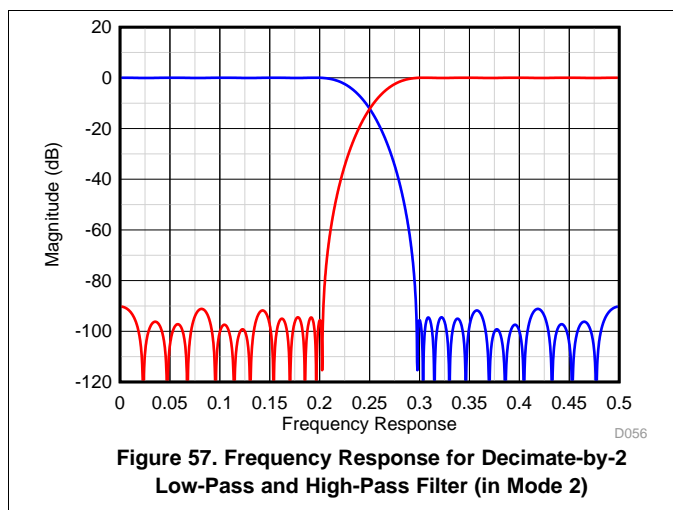

Figure 56. Filtering in Mode 2

Table 4. Filter Specification Details, Mode 2

CORNERS	LOW PASS	HIGH PASS
-0.1 dB	$0.204 \times f_s$	$0.296 \times f_s$
-0.5 dB	$0.211 \times f_s$	$0.290 \times f_s$
-1 dB	$0.216 \times f_s$	$0.284 \times f_s$
-3 dB	$0.226 \times f_s$	$0.274 \times f_s$



7.4.4 Modes 4 and 7, Decimation-by-2 with Real Outputs for up to 110 MHz of Bandwidth

In this configuration, the DDC block includes a selectable $N \times f_s / 16$ complex digital mixer (N from -8 to $+7$) preceding the decimation-by-2 digital filter also with an IQ passband of approximately ± 55 MHz (3 dB) centered at $N \times f_s / 16$. A positive value for N inverts the spectrum. In addition, a $f_s / 8$ complex digital mixer is added after the decimation filter transforming the output back to real format and centers the output spectrum within the Nyquist zone.

In addition, the ADS54J66 supports a 0-pad feature where a sample with value = 0 is added after each sample. In this way the output data rate is interpolated to 500 MSPS (real) with a second image inverted at $f_s / 2 - f_{IN}$.

The stop-band attenuation is approximately 90 dB for in-band aliases from negative frequencies and approximately 55 dB for out-of-band aliases. The passband flatness is ± 0.1 dB. Figure 59 shows the filtering operation in DDC mode 4 and 7. Table 5 shows corner frequencies of decimation filter in DDC mode 4 and 7. Figure 60 and Figure 61 show frequency response of the filter.

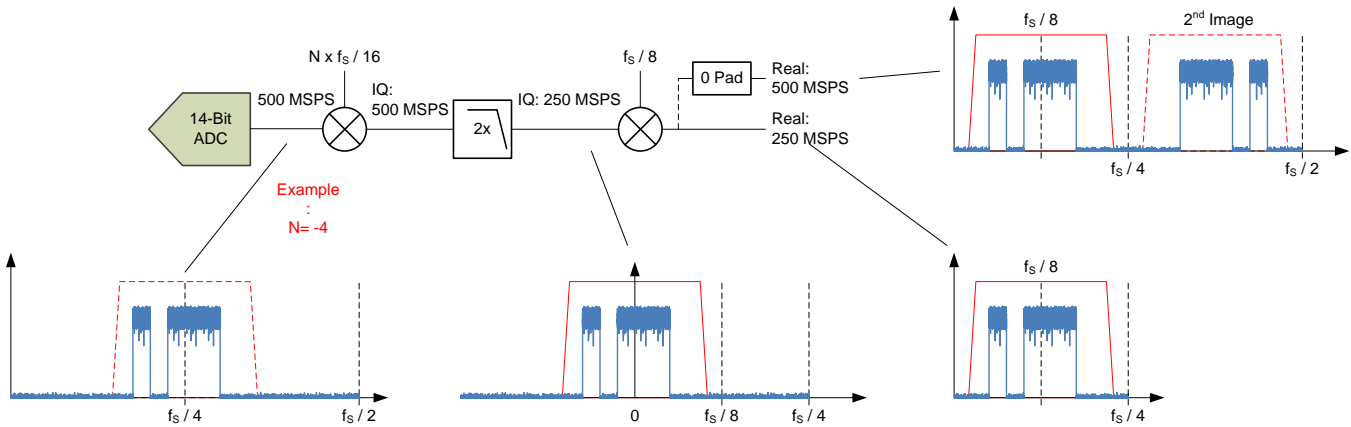

Figure 59. Mixing and Filtering in Modes 4 and 7

Table 5. Filter Specification Details, Modes 4 and 7

CORNERS	LOW PASS
-0.1 dB	$0.102 \times f_s$
-0.5 dB	$0.105 \times f_s$
-1 dB	$0.108 \times f_s$
-3 dB	$0.113 \times f_s$

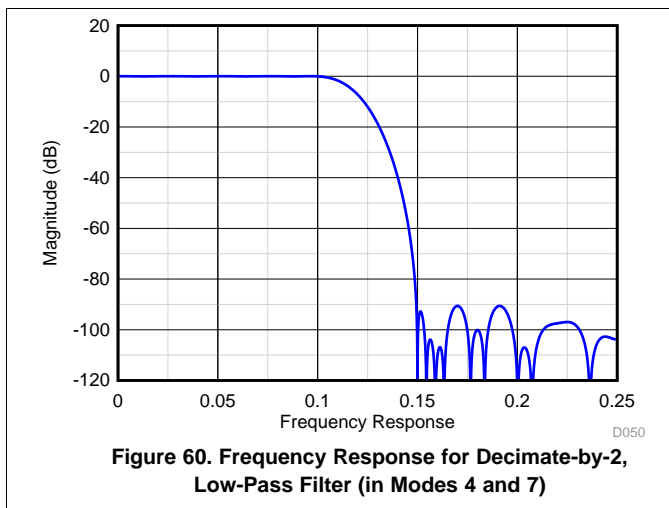

Figure 60. Frequency Response for Decimate-by-2, Low-Pass Filter (in Modes 4 and 7)

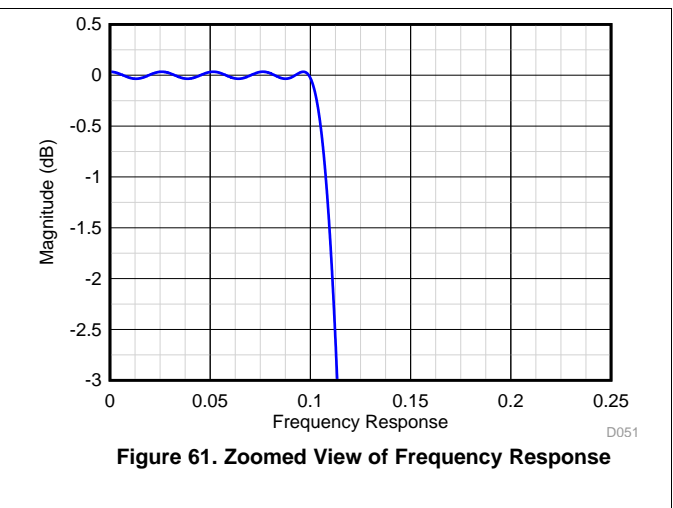

Figure 61. Zoomed View of Frequency Response

7.4.5 Mode 5, Decimation-by-2 with IQ Outputs for up to 110 MHz of IQ Bandwidth

In this configuration, the DDC block includes a selectable $N \times f_s / 16$ complex digital mixer (N from -8 to $+7$) preceding the decimation-by-2 digital filter, so the IQ passband is approximately ± 55 MHz (3 dB) centered at $N \times f_s / 16$. A positive value for N inverts the spectrum.

The stop-band attenuation is approximately 90 dB for in-band aliases from negative frequencies. The pass-band flatness is ± 0.1 dB. Figure 62 shows the filtering operation in DDC mode 5. Table 6 shows corner frequencies of decimation filter in DDC mode 5. Figure 63 and Figure 64 show frequency response of the filter. Figure 62 shows the filtering operation in DDC mode 5. Table 6 shows corner frequencies of decimation filter in DDC mode 5. Figure 63 and Figure 64 show frequency response of the filter.

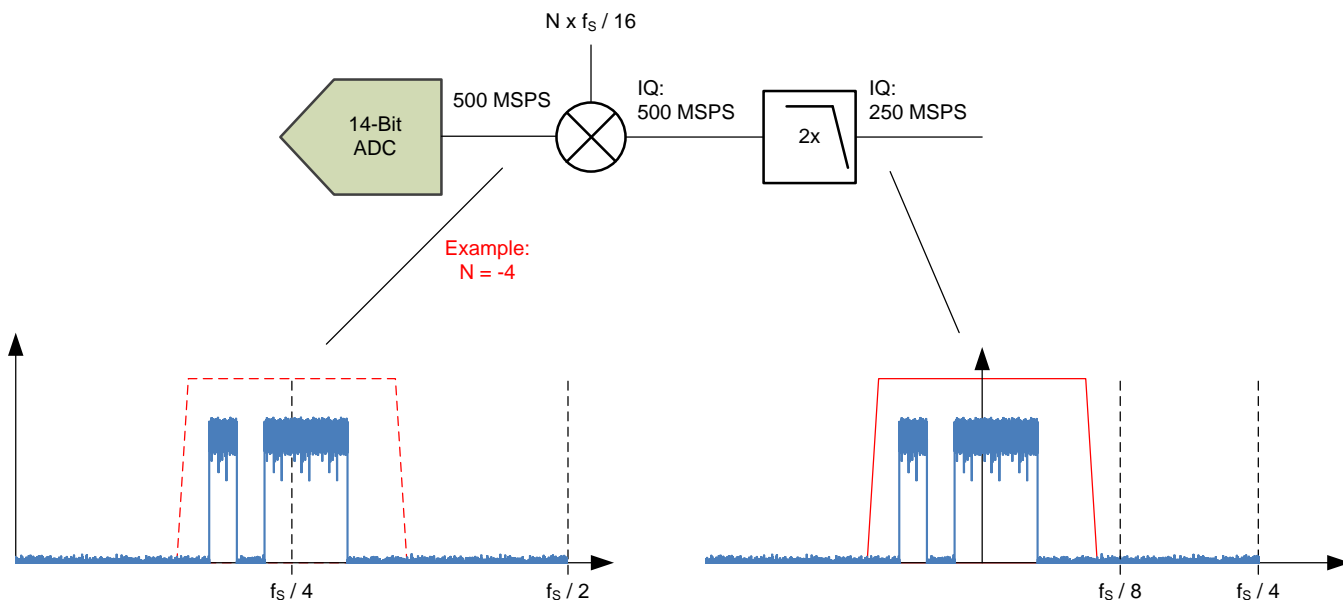

Figure 62. Mixing and Filtering in Mode 5

Table 6. Filter Specification Details, Mode 5

CORNERS	LOW PASS
-0.1 dB	$0.102 \times f_s$
-0.5 dB	$0.105 \times f_s$
-1 dB	$0.108 \times f_s$
-3 dB	$0.113 \times f_s$

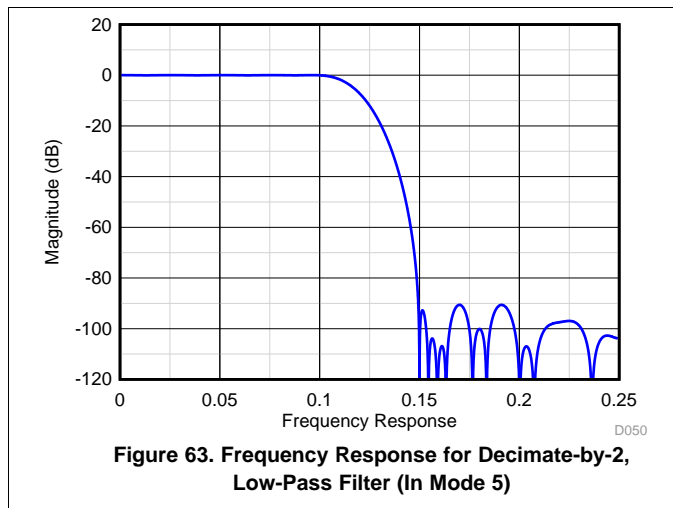

Figure 63. Frequency Response for Decimate-by-2, Low-Pass Filter (In Mode 5)

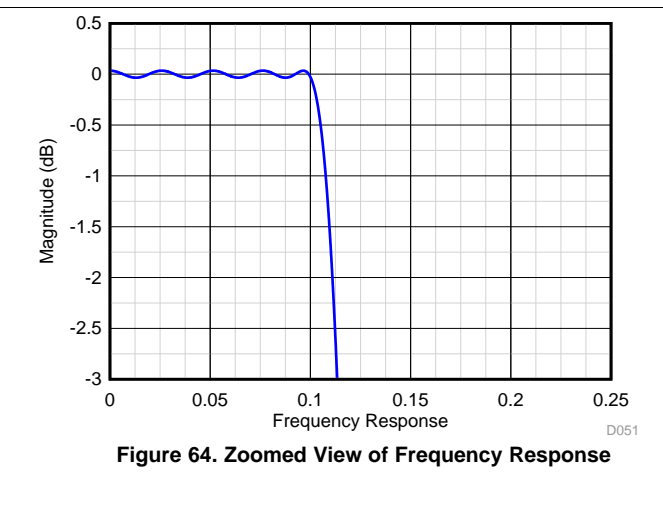

Figure 64. Zoomed View of Frequency Response

7.4.6 Mode 6, Decimation-by-4 with IQ Outputs for up to 110 MHz of IQ Bandwidth

In this configuration, the DDC block includes a selectable $N \times f_s / 16$ complex digital mixer (n from -8 to $+7$) preceding the decimation-by-4 digital filter, so the IQ passband is approximately ± 55 MHz (3 dB) centered at $N \times f_s / 16$. A positive value for N inverts the spectrum. **Figure 65** shows the filtering operation in DDC mode 6. **Table 7** shows corner frequencies of decimation filter in DDC mode 6. The decimation-by-4 filter is a cascade of two decimation-by-2 filters with frequency response shown in **Figure 66** and **Figure 67**.

The stop-band attenuation is approximately 90 dB for in-band aliases from negative frequencies and approximately 55 dB for out-of-band aliases. The pass-band flatness is ± 0.1 dB.

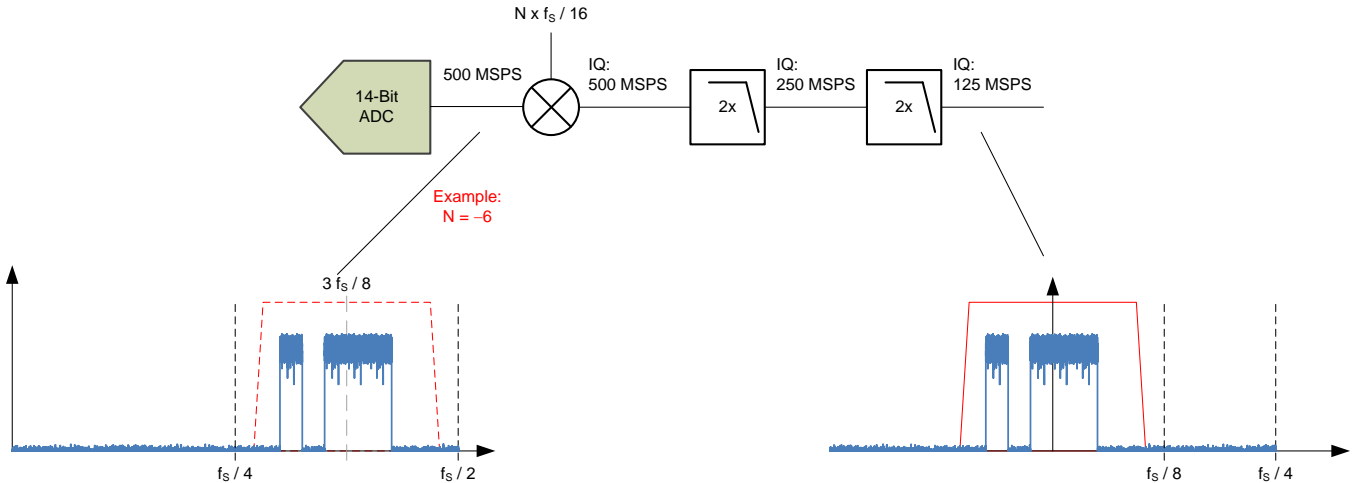

Figure 65. Mixing and Filtering in Mode 6

Table 7. Filter Specification Details, Mode 6

CORNERS	LOW PASS
-0.1 dB	$0.102 \times f_s$
-0.5 dB	$0.105 \times f_s$
-1 dB	$0.108 \times f_s$
-3 dB	$0.113 \times f_s$

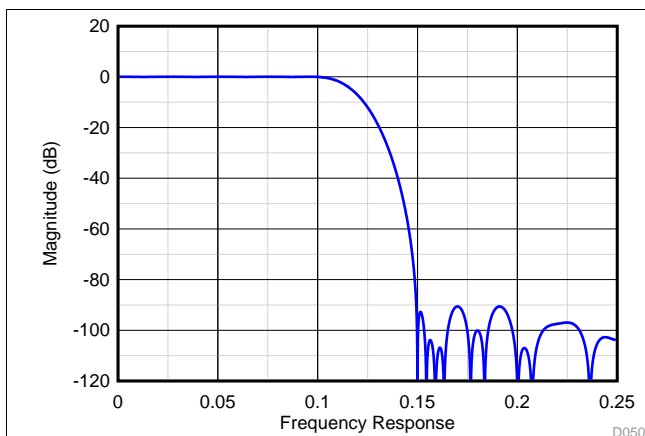

Figure 66. Frequency Response for Decimate-by-2, Low-Pass Filter (in Mode 6)

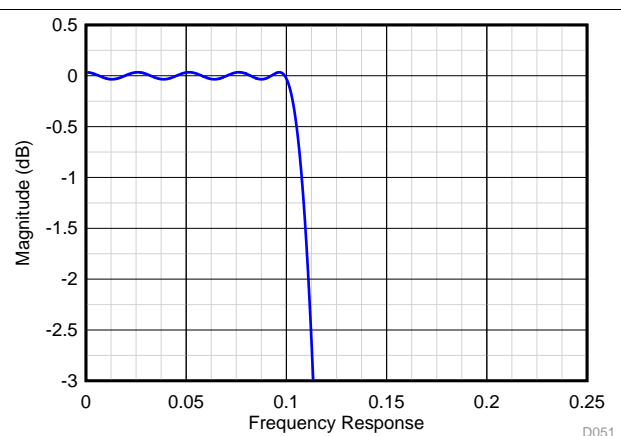

Figure 67. Zoomed View of Frequency Response

7.4.7 Overrange Indication

The ADS54J66 provides a fast overrange indication (FOVR) that can be presented in the digital output data stream via SPI configuration. When the FOVR indication is embedded in the output data stream, it replaces the LSB (normal 0) of the 16 bit going to the 8b/10b encoder as shown in Figure 68.

One threshold is set per channel pair A, B and C, D.

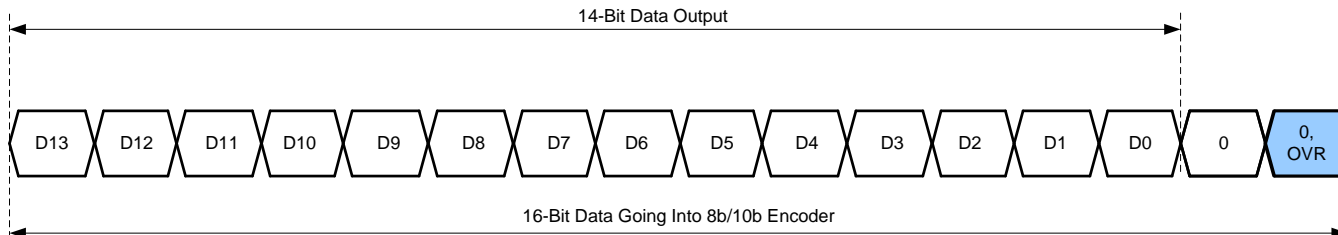

Figure 68. Timing Diagram for FOVR

The fast OVR is triggered if the input voltage exceeds the programmable overrange threshold and it gets presented after just 44 input clock cycles enabling a quicker reaction to an overrange event.

The input voltage level at which the overload is detected is referred to as the threshold. It is programmable using the FOVR THRESHOLD bits.

The input voltage level that fast OVR is triggered is:

$$\text{Full-scale} \times [\text{the decimal value of the FOVR threshold bits}] / 255$$

The default threshold is E3h (227), corresponding to a threshold of –1 dBFS.

In terms of full-scale input, the fast OVR threshold can be calculated as shown in Equation 1:

$$20 \times \log (<\text{FOVR Threshold}> / 255). \tag{1}$$

Table 8 is an example register write to set the FOVR threshold for all four channels.

Table 8. Register Sequence for FOVR Configuration

ADDRESS	DATA	COMMENT
11h	80h	Go to master page
59h	20h	Set the ALWAYS WRITE 1 bit. This bit configures the OVR signal as fast OVR.
11h	FFh	Go to ADC page
5Fh	FFh	Set FOVR threshold for all channels to 255
4004h	68h	Go to main digital page of the JESD bank
4003h	00h	
60ABh	01h	Enable bit D0 overwrite
70ABh	01h	
60ADh	03h	Select FOVR to replace bit D0
70ADh	03h	
6000h	01h	Pulse the IL RESET register bit. Register writes in main digital page take effect when the IL RESET register bit is pulsed.
7000h	01h	
6000h	00h	
7000h	00h	

7.4.8 Power-Down Mode

The ADS54J66 provides a highly-configurable power-down mode. Power-down can be enabled using the PDN pin or SPI register writes.

A power-down mask can be configured that allows a trade-off between wake-up time and power consumption in power-down mode. Two independent power-down masks can be configured: MASK 1 and MASK 2, as shown in [Table 9](#). See the master page registers in [Table 15](#) for further details.

Table 9. Register Address for Power-Down Modes

REGISTER ADDRESS A[7:0] (Hex)	COMMENT	REGISTER DATA							
		7	6	5	4	3	2	1	0
MASTER PAGE (80h)									
20	MASK 1	PDN ADC CHAB				PDN ADC CHCD			
21		PDN BUFFER CHCD	PDN BUFFER CHAB		0	0	0	0	
23	MASK 2	PDN ADC CHAB				PDN ADC CHCD			
24		PDN BUFFER CHCD	PDN BUFFER CHAB		0	0	0	0	
26	CONFIG	GLOBAL PDN	OVERRIDE PDN PIN	PDN MASK SEL	0	0	0	0	
53		0	MASK SYSREF	0	0	0	0	0	
55		0	0	0	PDN MASK	0	0	0	

To save power, the device can be put in complete power down by using the GLOBAL PDN register bit. However, when JESD link must remain up when putting the device in power down, the ADC and analog buffer can be powered down by using the PDN ADC CHx and PDN BUFFER CHx register bits after enabling the PDN MASK register bit. The PDN MASK SEL register bit can be used to select between MASK 1 or MASK 2. [Table 10](#) shows power consumption for different combinations of the GLOBAL PDN, PDN ADC CHx, and PDN BUFF CHx register bits.

Table 10. Power Consumption in Different Power-Down Settings

REGISTER BIT	COMMENT	IAVDD3V (mA)	IAVDD (mA)	IDVDD (mA)	IIOVDD (mA)	TOTAL POWER (W)
Default	After reset, with a full-scale input signal to both channels	0.340	0.365	0.184	0.533	2.675
GBL PDN = 1	The device is in complete power-down state	0.002	0.006	0.012	0.181	0.247
GBL PDN = 0, PDN ADC CHx = 1 (x = AB or CD)	The ADCs of one pair of channels are powered down	0.277	0.225	0.123	0.496	2.063
GBL PDN = 0, PDN BUFF CHx = 1 (x = AB or CD)	The input buffers of one pair of channels are powered down	0.266	0.361	0.187	0.527	2.445
GBL PDN = 0, PDN ADC CHx = 1, PDN BUFF CHx = 1 (x = AB or CD)	The ADCs and input buffers of one pair of channels are powered down	0.200	0.224	0.126	0.492	1.830
GBL PDN = 0, PDN ADC CHx = 1, PDN BUFF CHx = 1 (x = AB and CD)	The ADCs and input buffers of all channels are powered down	0.060	0.080	0.060	0.448	0.960

7.5 Programming

7.5.1 Device Configuration

The ADS54J66 can be configured using a serial programming interface, as described in this section. In addition, the device has one dedicated parallel pin (PDN) for controlling the power-down modes. The ADS54J66 supports a 24-bit (16-bit address, 8-bit data) SPI operation and uses paging (see the *Detailed Register Information* section) to access all register bits. Figure 69 shows timing diagram for serial interface signals. SPI registers are grouped in two banks with each bank containing different pages (see Figure 84).

First 4 MSBs of 16-bit address are special bits carrying information about register bank, page and channel to be programmed. Table 11 lists the purpose of each special bit.

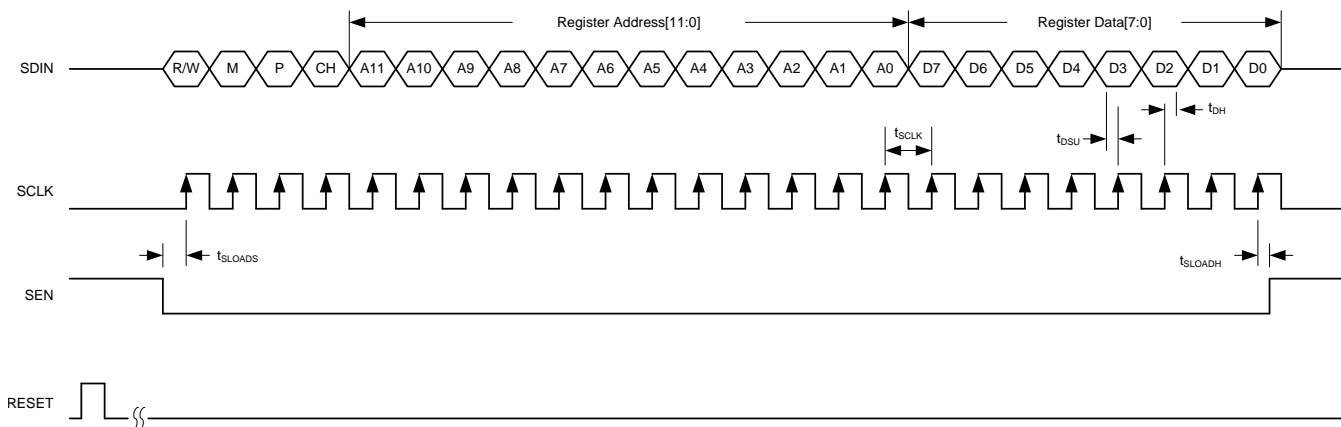

Figure 69. Serial Interface Timing Diagram

Table 11. Programming Details of Serial Interface

SPI BITS	DESCRIPTION	OPTIONS
R/W	Read/write bit	0 = SPI write 1 = SPI read back
M	SPI bank access	0 = Analog SPI bank (master and ADC page) 1 = Digital SPI bank (main digital, analog JESD, and digital JESD pages)
P	JESD page selection bit	0 = Page access 1 = Register access
CH	SPI access for a specific channel of the digital SPI bank	0 = Channel AB 1 = Channel CD By default, both channels are being addressed.
ADDR [11:0]	SPI address bits	—
DATA [7:0]	SPI data bits	—

7.5.1.1 Details of the Serial Interface

The ADC has a set of internal registers that can be accessed by the serial interface formed by the SEN (serial interface enable), SCLK (serial interface clock) and SDIN (serial interface data) pins. Serially shifting bits into the device is enabled when SEN is low. Serial data on SDIN are latched at every SCLK rising edge when SEN is active (low). The interface can function with SCLK frequencies from 5 MHz down to very low speeds (of a few hertz) and also with a non-50% SCLK duty cycle.

Figure 74 shows timing requirements for serial interface signals.

Table 12. Serial Interface Timing Requirements⁽¹⁾

		MIN	MAX	UNIT
f_{SCLK}	SCLK frequency (equal to $1 / t_{SCLK}$)	> dc	20	MHz
t_{SLOADS}	SEN to SCLK setup time	25		ns
t_{SLOADH}	SCLK to SEN hold time	25		ns
t_{DSU}	SDATA setup time	25		ns
t_{DH}	SDATA hold time	25		ns

(1) Typical values are at 25°C. Minimum and maximum values are across the full temperature range of $T_{MIN} = -40^{\circ}C$ to $T_{MAX} = 100^{\circ}C$, $AVDD3V = 3V$, $AVDD = 1.9V$, and $DRVDD = 1.8V$, unless otherwise noted.

7.5.1.2 Serial Register Write: Analog Bank

The analog SPI bank contains of two pages (the master and ADC page). The internal register of the ADS54J66 analog SPI bank can be programmed by:

1. Drive the SEN pin low.
2. Initiate a serial interface cycle specifying the page address of the register whose content must be written.
 - Master page: write address 0011h with 80h.
 - ADC page: write address 0011h with 0Fh.
3. Write the register content as shown in Figure 70. When a page is selected, multiple writes into the same page can be done.

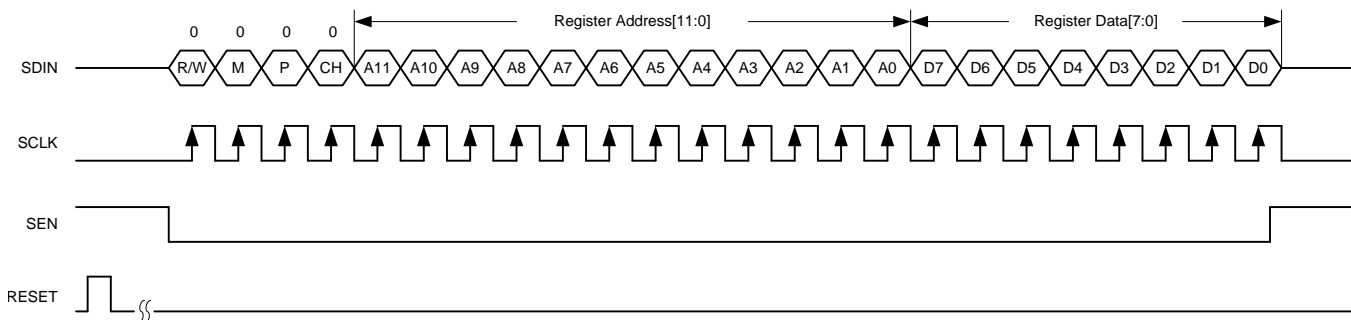

Figure 70. Serial Register Write Timing Diagram

7.5.1.3 Serial Register Readout: Analog Bank

The content from one of the two analog banks can be read out by:

1. Drive the SEN pin low.
2. Select the page address of the register whose content must be read.
 - Master page: write address 0011h with 80h.
 - ADC page: write address 0011h with 0Fh.
3. Set the R/W bit to 1 and write the address to be read back.
4. Read back the register content on the SDOOUT pin, as shown in [Figure 71](#). When a page is selected, multiple read backs from the same page can be done.

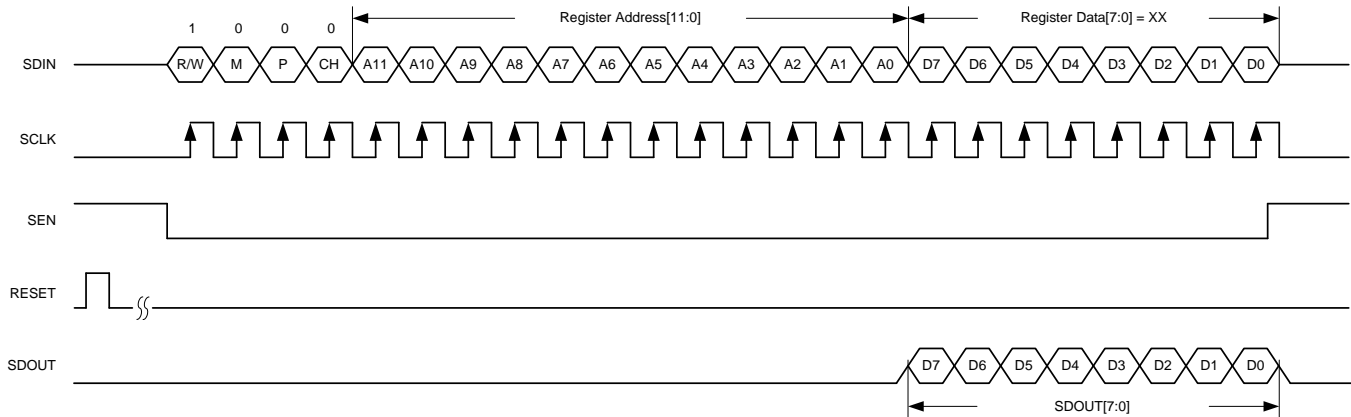

Figure 71. Serial Register Read Timing Diagram

7.5.1.4 JESD Bank SPI Page Selection

The JESD SPI bank contains five pages (main digital, interleaving engine, decimation filter, JESD digital, and JESD analog). The individual pages can be selected following these steps:

1. Drive the SEN pin low.
2. Set the M bit to 1 and specify the page with two register writes (Note: the P bit is set to 0)
 - Write address 4003h with 00h (LSB byte of the page address)
 - Write address 4004h MSB byte of the page address
 - Main digital page: write address = 4004h with 68h (default)
 - Digital JESD page: write address = 4004h with 69h
 - Analog JESD page: write address = 4004h with 6Ah
 - Interleaving engine page: write address = 4004h with 61h
 - Decimation filter page: write address = 4004h with 61h and 4003h with 41h

Figure 72 shows the serial interface signals when pages in the JESD bank are being accessed. Note that the P bit is set to 0.

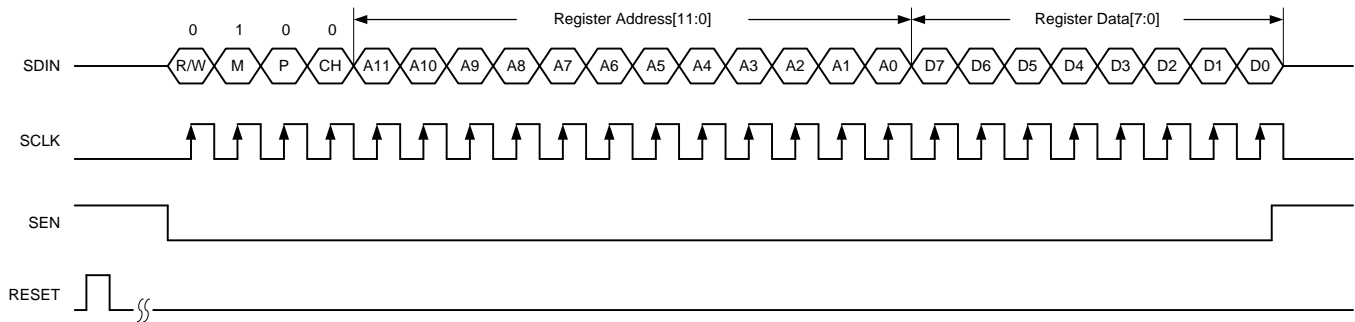

Figure 72. SPI Timing Diagram for Accessing a Page in the JESD Bank

7.5.1.5 Serial Register Write: Digital Bank

The ADS54J66 is a quad-channel device and the JESD204B portion is configured individually for two channels (A, B and C, D) using the CH bit. Note that the P bit must be set to 1 for register writes.

1. Drive the SEN pin low.
2. Select the JESD bank page (Note: M bit = 1, P bit = 0)
 - Write address 4003h with 00h
 - Main digital page: write address = 4004h with 68h (default)
 - Digital JESD page: write address = 4004h with 69h
 - Analog JESD page: write address = 4004h with 6Ah
 - Interleaving Engine page: write address = 4004h with 61h
 - Decimation Filter page: write address = 4004h with 61h and 4003h with 41h
3. Set the M and P bit to 1 and select channels A, B (CH = 0) or C, D (CH = 1) and write the register content. When a page is selected, multiple writes into the same page can be done.

By default, register writes are applied to both channel pairs (broadcast mode). To disable broadcast mode and enable individual channel writes, write address 4005h with 01h (default is 00h).

Figure 73 shows the serial interface signals when a register in the desired page of the JESD bank is programmed (note that the P bit must be set to 1 in this step).

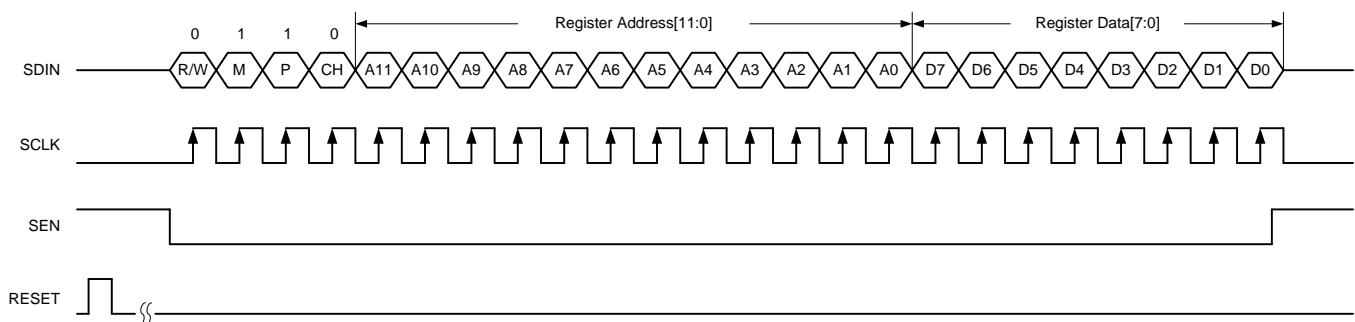

Figure 73. SPI Timing Diagram for Writing a Register in the JESD Bank (After Page is Accessed)

7.5.1.6 Individual Channel Programming

By default, register writes are applied to both channels in a group (for example, the register writes are applied to channels A and B if the CH bit is 0, or the register writes are applied to channels C and D if the CH bit is 1). This form of programming is referred to as *broadcast mode*.

For pages located in the JESD bank, the device gives flexibility to program each channel individually. To enable individual channel writes, write address 4005h with 01h (default is 00h).

7.5.1.7 Serial Register Readout: JESD Bank

SPI read out of content in one of the three digital banks can be accomplished with the following steps:

1. Drive the SEN pin low.
2. Select the digital bank page (Note: M bit = 1, P bit = 0)
 - Write address 4003h with 00h
 - Main digital page: write address = 4004h with 68h
 - Digital JESD page: write address = 4004h with 69h
 - Analog JESD page: write address = 4004h with 6Ah
 - Interleaving engine page: write address = 4004h with 61h
 - Decimation filter page: write address = 4004h with 61h and 4003h with 41h
3. Set the R/W bit, M and P bit to 1 and select channels A, B or C, D and write the address to be read back.
4. Read back register content on the SDOUT pin. When a page is selected, multiple read backs from the same page can be done.

Figure 74 shows the serial interface signals when the contents of a register in the desired page of the JESD bank are being read-back (note that the P bit must be set to 1 in this step).

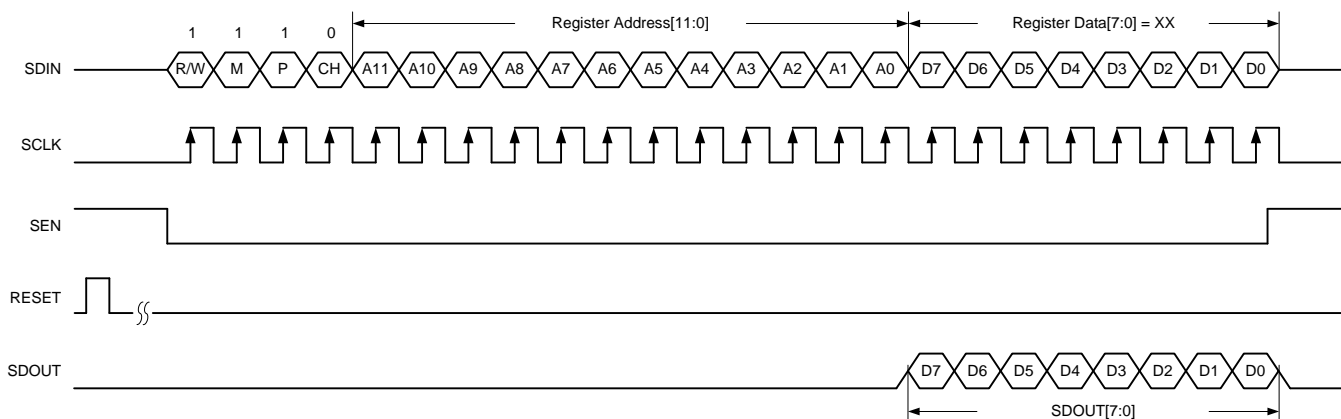

Figure 74. Serial Register Read Timing Diagram

7.5.2 JESD204B Interface

The ADS54J66 supports device subclass 1 with a maximum output data rate of 10 Gbps for each serial transmitter. Figure 75 shows JESD204B block inside ADS54J66.

An external SYSREF signal is used to align all internal clock phases and the local multi frame clock to a specific sampling clock edge. This process allows synchronization of multiple devices in a system and minimizes timing and alignment uncertainty. The ADS54J66 supports single (for all four JESD links) or dual (for channel A, B and C, D) SYNCb inputs and can be configured via SPI as shown in Figure 76.

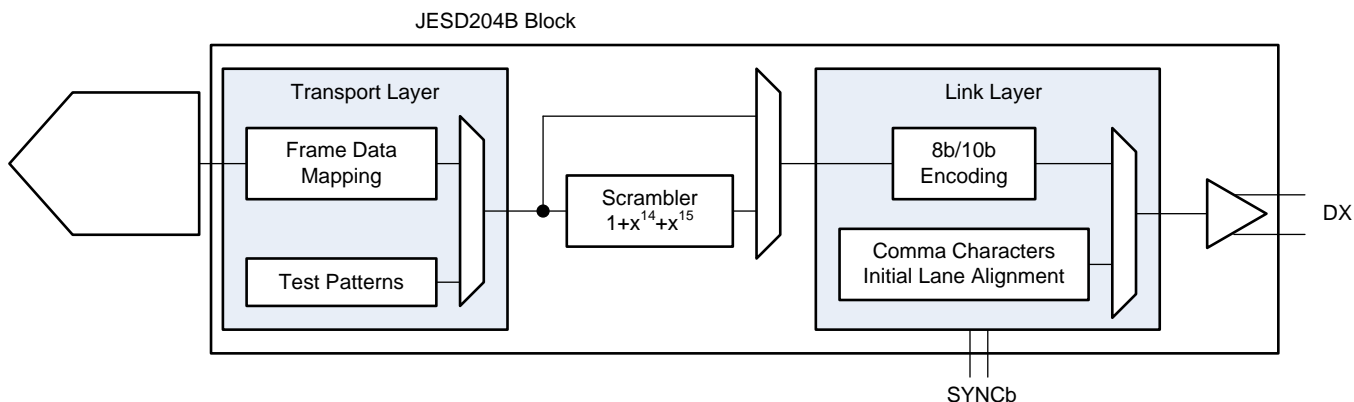

Figure 75. JESD Interface Block Diagram

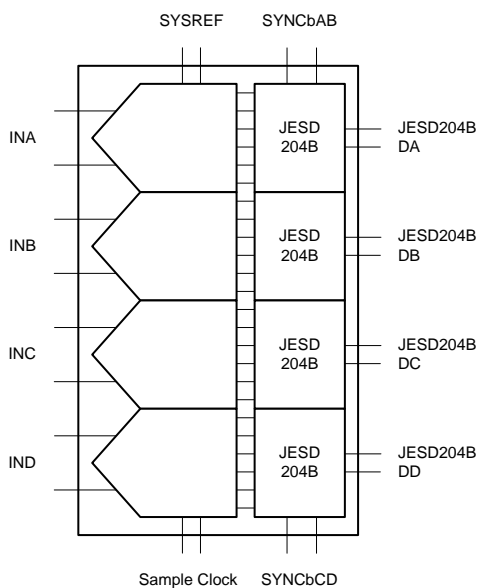

Figure 76. JESD204B Transmitter Block

Depending on the ADC sampling rate, the JESD204B output interface can be operated with one lane per channel. The JESD204B setup and configuration of the frame assembly parameters is handled via SPI interface.

The JESD204B transmitter block consists of the transport layer, the data scrambler and the link layer. The transport layer maps the ADC output data into the selected JESD204B frame data format and manages if the ADC output data or test patterns are being transmitted. The link layer performs the 8b/10b data encoding as well as the synchronization and initial lane alignment using the SYNC input signal. Optionally data from the transport layer can be scrambled.

7.5.2.1 JESD204B Initial Lane Alignment (ILA)

The initial lane alignment process is started by the receiving device by de-asserting the SYNCb signal. Upon detecting a logic low on the SYNC input pins, the ADS54J66 starts transmitting comma (K28.5) characters to establish code group synchronization as shown in Figure 77.

When synchronization is completed the receiving device re-asserts the SYNCb signal and the ADS54J66 starts the initial lane alignment sequence with the next local multi frame clock boundary. The ADS54J66 transmits four multi-frames each containing K frames (K is SPI programmable). Each of the multi-frames contains the frame start and end symbols and the second multi-frame also contains the JESD204 link configuration data.

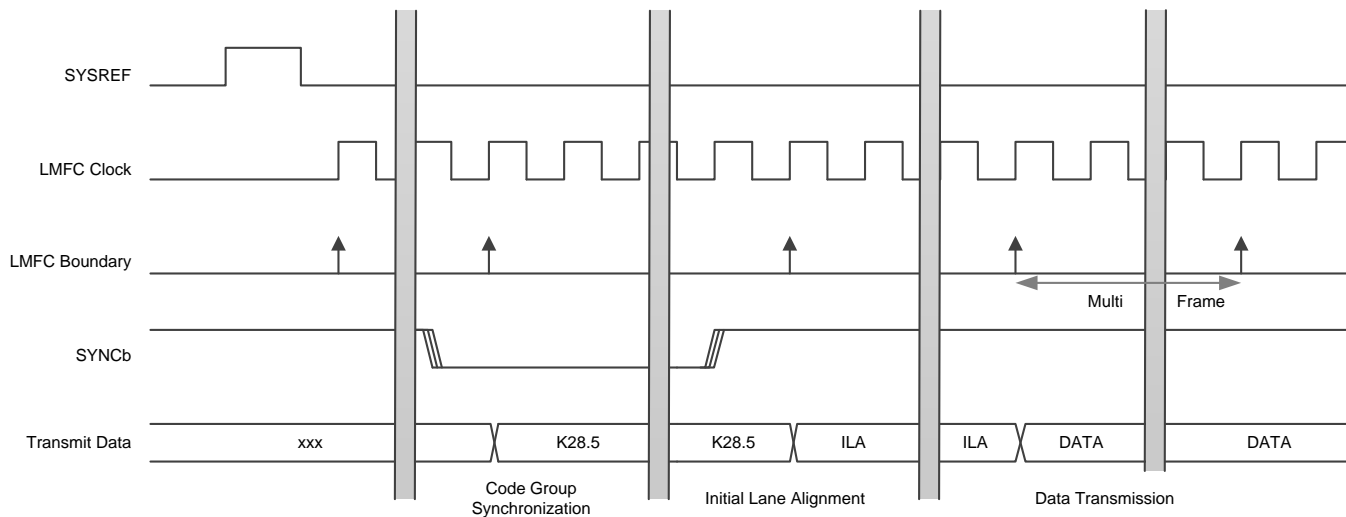

Figure 77. ILA Sequence

7.5.2.2 JESD204B Frame Assembly

The JESD204B standard defines the following parameters:

- L is the number of lanes per link.
- M is the number of converters per device.
- F is the number of octets per frame clock period.
- S is the number of samples per frame.

Table 13 lists the available JESD204B formats and valid ranges for the ADS54J66. The ranges are limited by the Serdes line rate and the maximum ADC sample frequency.

Table 13. Available JESD204B Formats and Valid Ranges for the ADS54J66

L	M	F	S	OPERATING MODE	DIGITAL MODE	OUTPUT FORMAT	JESD MODE ⁽¹⁾	JESD PLL MODE ⁽²⁾	MAX ADC OUTPUT RATE (MSPS)	MAX f _{SERDES} (Gbps)
4	8	4	1	0,5	2x decimation	Complex	40x	40x	250	10.0
4	4	2	1	2,4	2x decimation	Real	20x	20x	250	5.0
2	4	4	1	2,4	2x decimation	Real	40x	40x	250	10.0
4	8	4	1	6	4x decimation	Complex	40x	20x	125	5.0
2	8	8	1	6	4x decimation	Complex	80x	40x	125	10.0
4	4	2	1	7	2x decimation with 0-pad	Real	20x	40x	500	10.0
4	4	2	1	8	No decimation	Real	20x	40x	500	10.0

(1) In register 01h of the JESD digital page.
 (2) In register 16h of the JESD analog page.

The detailed frame assembly is shown in Table 14.

Table 14. Detailed Frame Assembly

	LMFS = 4841				LMFS = 4421				LMFS = 4421 (0-Pad)			
DA	Ai0[15:8]	Ai0[7:0]	AQ0[15:8]	AQ0[7:0]	A0[15:8]	A0[7:0]	A1[15:8]	A1[7:0]	A0[15:8]	A0[7:0]	0000 0000	0000 0000
DB	Bi0[15:8]	Bi0[7:0]	BQ0[15:8]	BQ0[7:0]	B0[15:8]	B0[7:0]	B1[15:8]	B1[7:0]	B0[15:8]	B0[7:0]	0000 0000	0000 0000
DC	CI0[15:8]	CI0[7:0]	CQ0[15:8]	CQ0[7:0]	C0[15:8]	C0[7:0]	C1[15:8]	C1[7:0]	C0[15:8]	C0[7:0]	0000 0000	0000 0000
DD	Di0[15:8]	Di0[7:0]	DQ0[15:8]	DQ0[7:0]	D0[15:8]	D0[7:0]	D1[15:8]	D1[7:0]	D0[15:8]	D0[7:0]	0000 0000	0000 0000

	LMFS = 2441				LMFS = 2881							
DB	A0[15:8]	A0[7:0]	B0[15:8]	B0[7:0]	Ai0[15:8]	Ai0[7:0]	AQ0[15:8]	AQ0[7:0]	Bi0[15:8]	Bi0[7:0]	BQ0[15:8]	BQ0[7:0]
DC	C0[15:8]	C0[7:0]	D0[15:8]	D0[7:0]	CI0[15:8]	CI0[7:0]	CQ0[15:8]	CQ0[7:0]	DI0[15:8]	DI0[7:0]	DQ0[15:8]	DQ0[7:0]

7.5.2.3 JESD Output Switch

The ADS54J66 provides a digital cross point switch in the JESD204B block which allows internal routing of any output of the two ADCs within one channel pair to any of the two JESD204B serial transmitters in order to ease layout constraints. The cross-point switch routing is configured via SPI (address 21h in the JESD digital page, as shown in Figure 78).

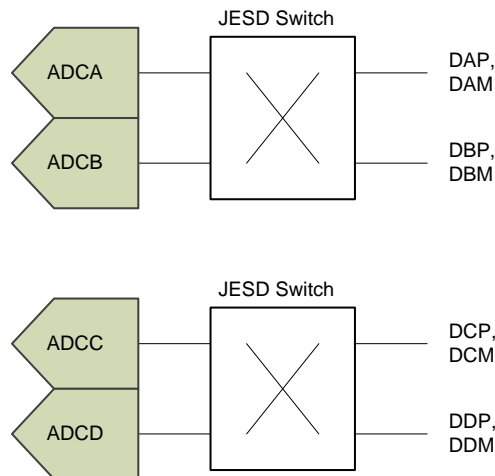

Figure 78. Switching the Output Lanes

7.5.2.3.1 SERDES Transmitter Interface

Each of the 10 Gbps serdes transmitter outputs requires ac coupling between transmitter and receiver. The differential pair must be terminated with $100\ \Omega$ as close to the receiving device as possible to avoid unwanted reflections and signal degradation as shown in Figure 79.

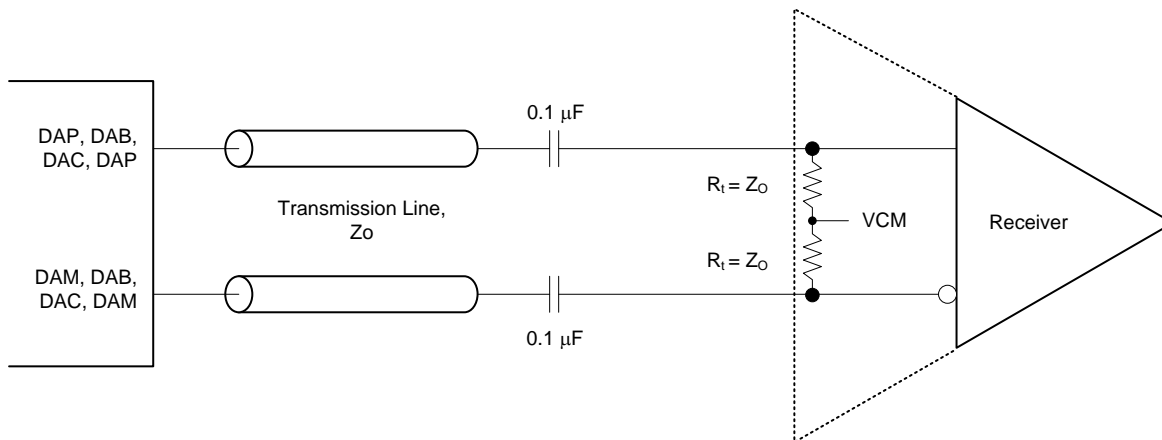

Figure 79. SERDES Transmitter Connection to Receiver

7.5.2.3.2 SYNCb Interface

The ADS54J66 supports single (either SYNCb input controls all four JESD204B links) or dual (one SYNCb input controls two JESD204B lanes (DA, DB and DC, DD) SYNCb control. When using single SYNCb control, connect the unused input to differential logic low (SYNCbxxP = 0 V, SYNCbxxM = IOVDD).

ADS54J66

SBAS745A –NOVEMBER 2015–REVISED DECEMBER 2015

www.ti.com

7.5.2.3.3 Eye Diagram

Figure 80 to Figure 83 show the serial output eye diagrams of the ADS54J66 at 5 Gbps and 10 Gbps with default and increased output voltage swing against the JESD204B mask.



Figure 80. Eye at 5-Gbps Bit Rate with Default Output Swing



Figure 81. Eye at 5-Gbps Bit Rate with Increased Output Swing

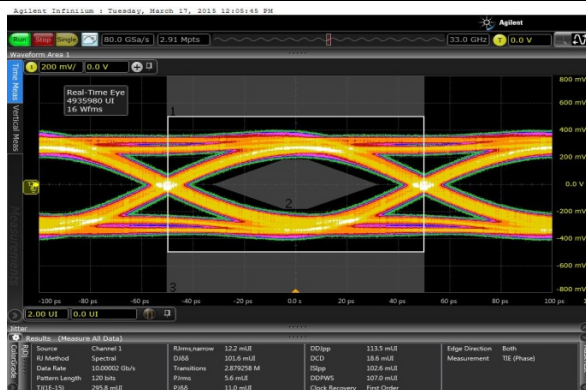

Figure 82. Eye at 10-Gbps Bit Rate with Default Output Swing

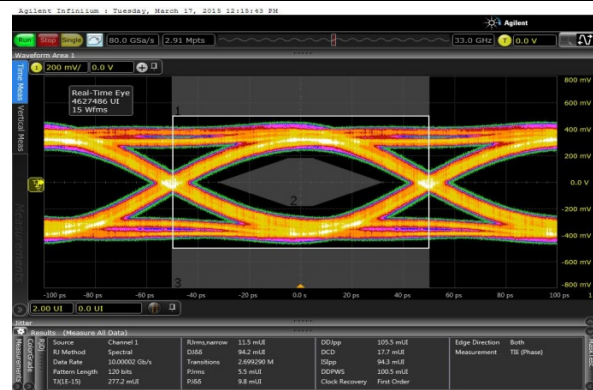

Figure 83. Eye at 10-Gbps Bit Rate with Increased Output Swing

7.6 Register Maps

The conceptual diagram of the serial registers is shown in [Figure 84](#).

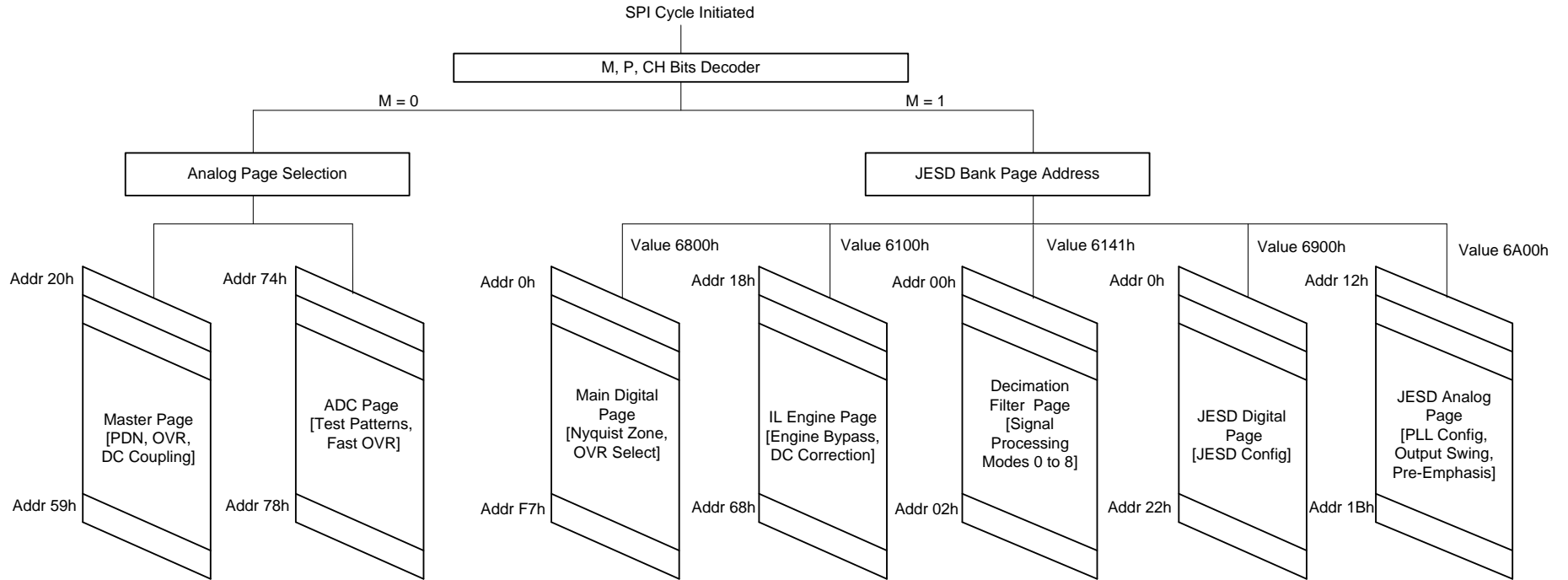

Figure 84. Serial Interface Registers

Register Maps (continued)

7.6.1 Detailed Register Information

The ADS54J66 contains two main SPI banks. The analog SPI bank gives access to the ADC cores and the digital SPI bank controls the serial interface. The analog SPI bank is divided into two pages (master and ADC) and the digital SPI bank is divided into five pages (main digital, interleaving engine, decimation filter, JESD digital, and JESD analog; see [Figure 84](#)). [Table 15](#) gives a summary of all programmable registers in the pages of different banks in the ADS54J66.

Table 15. Register Map

REGISTER ADDRESS A[7:0] (Hex)	REGISTER DATA							
	7	6	5	4	3	2	1	0
GENERAL REGISTERS								
0	RESET	0	0	0	0	0	0	RESET
3	JESD BANK PAGE SEL [7:0]							
4	JESD BANK PAGE SEL [15:8]							
5	0	0	0	0	0	0	0	DIS BROADCAST
11	ANALOG PAGE SELECTION [7:0]							
MASTER PAGE (80h)								
20	PDN ADC CHAB				PDN ADC CHCD			
21	PDN BUFFER CHCD		PDN BUFFER CHAB		0	0	0	0
23	PDN ADC CHAB				PDN ADC CHCD			
24	PDN BUFFER CHCD		PDN BUFFER CHAB		0	0	0	0
26	GLOBAL PDN	VERRIDE PDN PIN	PDN MASK SEL	0	0	0	0	0
3A	0	BUFFER CURR INCREASE	0	0	0	0	0	0
39	ALWAYS WRITE 1		0	0	0	0	0	0
53	CLK DIV	MASK SYSREF	0	0	0	0	0	0
55	0	0	0	PDN MASK	0	0	0	0
56	0	0	0	0	INPUT BUFF CURR EN	0	0	0
59	0	0	ALWAYS WRITE 1	0	0	0	0	0
ADC PAGE (0Fh)								
5F	FOVR THRESH							
60	PULSE BIT CHC	0	0	0	0	0	0	0
61	0	0	0	0	HD3 NYQ2 CHCD	0	0	PULSE BIT CHD
6C	PULSE BIT CHA	0	0	0	0	0	0	0
6D	0	0	0	0	HD3 NYQ2 CHAB	0	0	PULSE BIT CHB
74	TEST PATTERN ON CHANNEL				0	0	0	0
75	CUSTOM PATTERN 1 [13:6]							
76	CUSTOM PATTERN 1 [5:0]						0	0
77	CUSTOM PATTERN 2 [13:6]							
78	CUSTOM PATTERN 2 [5:0]						0	0

Register Maps (continued)

Table 15. Register Map (continued)

REGISTER ADDRESS A[7:0] (Hex)	REGISTER DATA							
	7	6	5	4	3	2	1	0
INTERLEAVING ENGINE PAGE (6100h)								
18	0	0	0	0	0	0	IL BYPASS	
68	0	0	0	0	0	DC CORR DIS		0
DECIMATION FILTER PAGE (6141h)								
0	CHB/C FINE MIX				DDC MODE			
1	0	0	0	0	DDC MODE6 EN1	ALWAYS WRITE 1	CHB/C HPF EN	CHB/C COARSE MIX
2	0	0	CHA/D HPF EN	CHA/D COARSE MIX	CHA/D FINE MIX			
MAIN DIGITAL PAGE (6800h)								
0	0	0	0	0	0	0	0	IL RESET
42	0	0	0	0	0	NYQUIST ZONE		
4E	CTRL NYQUIST ZONE	0	0	0	0	0	0	0
AB	0	0	0	0	0	0	0	OVR EN
AD	0	0	0	0	OVR ON LSB			
F7	0	0	0	0	0	0	0	DIG RESET
JESD DIGITAL PAGE (6900h)								
0	CTRL K	JESD MODE EN	DDC MODE6 EN2	TESTMODE EN	0	LANE ALIGN	FRAME ALIGN	TX LINK DIS
1	SYNC REG	SYNC REG EN	SYNCB SEL AB/CD	0	DDC MODE6 EN3	0	JESD MODE	
2	LINK LAYER TESTMODE			LINK LAYER RPAT	LMFC MASK RESET	0	0	0
3	FORCE LMFC COUNT	LMFC COUNT INIT				RELEASE I/LANE SEQ		
5	SCRAMBLE EN	0	0	0	0	0	0	0
6	0	0	0	FRAMES PER MULTI FRAME (K)				
19	0	0	0	0	LC [27:24]			
1A	LC [23:16]							
1B	LC [15:8]							
1C	LC [7:0]							
1D	0	0	0	0	HC [27:24]			
1E	HC [23:16]							
1F	HC [15:8]							
20	HC [7:0]							
21	OUPUT CHA MUX SEL		OUTPUT CHB MUX SEL		OUTPUT CHC MUX SEL		OUTPUT CHD MUX SEL	
22	0	0	0	0	OUT CHA INV	OUT CHB INV	OUT CHC INV	OUT CHD INV
JESD ANALOG PAGE (6A00h)								
12	SEL EMP LANE A/D						0	0
13	SEL EMP LANE B/C						0	0
16	0	0	0	0	0	0	JESD PLL MODE	
1B	JESD SWING			0	0	0	0	0

7.6.2 Example Register Writes

Global power down:

ADDRESS	DATA	COMMENT
11h	80h	Set master page
00h26	80h	Set global power down

Change decimation mode 0 to mode 4 adjusting both the LMFS configuration (LMFS = 4841 to 4421) as well as serial output data rate (10 Gbps to 5 Gbps):

ADDRESS	DATA	COMMENT
4004h	69h	Select digital JESD page
4003h	00h	
6000h	40h	Enables JESD mode overwrite
6001h	01h	Select digital to 20x mode
4004h	6Ah	Select analog JESD page
6016h	00h	Set serdes PLL to 20x mode
4004h	61h	Select decimation filter page
4003h	41h	
6000h	CCh	Select mode 4 Digital mixer for channel AB set to $-4 (f_s / 4)$
6002h	0Ch	Digital mixer for channel CD set to $-4 (f_s / 4)$

7.6.3 Register Descriptions

7.6.3.1 General Registers

7.6.3.1.1 Register 0h (offset = 0h) [reset = 0h]

Figure 85. Register 0h

7	6	5	4	3	2	1	0
RESET	0	0	0	0	0	0	RESET
R/W-0h	W-0h	W-0h	W-0h	W-0h	W-0h	W-0h	R/W-0h

LEGEND: R/W = Read/Write; W = Write only; -n = value after reset

Table 16. Register 0h Field Description

Bit	Name	Type	Reset	Description
7 ⁽¹⁾	RESET	R/W	0h	0 = Normal operation 1 = Internal software reset, clears back to 0
6-0	0	W	0h	Must write 0.
0 ⁽¹⁾	RESET	R/W	0h	0 = Normal operation 1 = Internal software reset, clears back to 0

(1) Both bits (7, 0) must be set simultaneously to exercise reset.

7.6.3.1.2 Register 3h, 4h (offset = 3h, 4h) [reset = 0h]

Figure 86. Register 3h

7	6	5	4	3	2	1	0
JESD BANK PAGE SEL [7:0]							
R/W-0h							

LEGEND: R/W = Read/Write; -n = value after reset

Figure 87. Register 4h

7	6	5	4	3	2	1	0
JESD BANK PAGE SEL [16:8]							
R/W-0h							

LEGEND: R/W = Read/Write; -n = value after reset

Table 17. Register 3h, 4h Field Description

Bit	Name	Type	Reset	Description
7-0	JESD BANK PAGE SEL	R/W	0h	Program these bits to access the desired page in the JESD bank. 6100h = Interleaving engine page selected 6141h = Decimation filter page selected 6800h = Main digital page selected 6900h = JESD digital page selected 6A00h = JESD analog page selected

7.6.3.1.3 Register 5h (offset = 5h) [reset = 0h]
Figure 88. Register 5h

7	6	5	4	3	2	1	0
0	0	0	0	0	0	0	DIS BROADCAST
W-0h	W-0h	W-0h	W-0h	W-0h	W-0h	W-0h	R/W-0h

LEGEND: R/W = Read/Write; W = Write only; -n = value after reset

Table 18. Register 5h Field Description

Bit	Name	Type	Reset	Description
7-1	0	W	0h	Must write 0.
0	DIS BROADCAST	R/W	0h	0 = Normal operation. Channel A and B are programmed as a pair. Channel C and D are programmed as a pair. 1 = channel A and B can be individually programmed based on the CH bit. Similarly channel C and D can be individually programmed based on the CH bit.

7.6.3.1.4 Register 11h (offset = 11h) [reset = 0h]
Figure 89. Register 11h

7	6	5	4	3	2	1	0
ANALOG PAGE SELECTION [7:0]							
R/W-0h							

LEGEND: R/W = Read/Write; -n = value after reset

Table 19. Register 11h Field Descriptions

Bit	Name	Type	Reset	Description
7-0	ANALOG PAGE SELECTION [7:0]	R/W	0h	Register page (only one page at a time can be addressed). Master page = 80h ADC page = 0Fh The five digital pages (main digital, interleaving engine, analog JESD, digital JESD, and decimation filter) are selected via the M bit. See Table 11 in the <i>Details of the Serial Interface</i> section for more details.

7.6.3.2 Master Page (80h)
7.6.3.2.1 Register 20h (address = 20h) [reset = 0h], Master Page (080h)
Figure 90. Register 20h

7	6	5	4	3	2	1	0
PDN ADC CHAB				PDN ADC CHCD			
R/W-0h				R/W-0h			

LEGEND: R/W = Read/Write; -n = value after reset

Table 20. Registers 20h Field Descriptions

Bit	Field	Type	Reset	Description
7-4	PDN ADC CHAB	R/W	0h	There are two power-down masks that are controlled via the PDN mask register bit in address 55h. The power-down mask 1 or mask 2 are selected via register bit 5 in address 26h. Power-down mask 1: addresses 20h and 21h. Power-down mask 2: addresses 23h and 24h. See the Power-Down Mode section for details.
3-0	PDN ADC CHCD	R/W	0h	

7.6.3.2.2 Register 21h (address = 21h) [reset = 0h], Master Page (080h)
Figure 91. Register 21h

7	6	5	4	3	2	1	0
PDN BUFFER CHCD		PDN BUFFER CHAB		0	0	0	0
R/W-0h		R/W-0h		W-0h	R/W-0h	R/W-0h	W-0h

LEGEND: R/W = Read/Write; W = Write only; -n = value after reset

Table 21. Register 21h Field Descriptions

Bit	Field	Type	Reset	Description
7-6	PDN BUFFER CHCD	R/W	0h	There are two power-down masks that are controlled via the PDN mask register bit in address 55h. The power-down mask 1 or mask 2 are selected via register address 26h, bit 5. Power-down mask 1: addresses 20h and 21h. Power-down mask 2: addresses 23h and 24h. See the Power-Down Mode section for details.
5-4	PDN BUFFER CHAB	R/W	0h	
3-0	0	W	0h	Must write 0.

7.6.3.2.3 Register 23h (address = 23h), Master Page (080h)
Figure 92. Register 23h

7	6	5	4	3	2	1	0
PDN ADC CHAB				PDN ADC CHCD			
R/W-0h				W-0h	R/W-0h	R/W-0h	W-0h

LEGEND: R/W = Read/Write; -n = value after reset

Table 22. Register 23h Field Descriptions

Bit	Field	Type	Reset	Description
7-4	PDN ADC CHAB	R/W	0h	There are two power-down masks that are controlled via the PDN mask register bit in address 55h. The power-down mask 1 or mask 2 are selected via register bit 5 in address 26h. Power-down mask 1: addresses 20h and 21h. Power-down mask 2: addresses 23h and 24h. See the Power-Down Mode section for details.
3-0	PDN ADC CHCD	R/W	0h	

7.6.3.2.4 Register 24h (address = 24h) [reset = 0h], Master Page (080h)
Figure 93. Register 24h

7	6	5	4	3	2	1	0
PDN BUFFER CHCD		PDN BUFFER CHAB		0	0	0	0
R/W-0h		R/W-0h		W-0h	R/W-0h	R/W-0h	R/W-0h

LEGEND: R/W = Read/Write; W = Write only; -n = value after reset

Table 23. Register 24h Field Descriptions

Bit	Field	Type	Reset	Description
7-6	PDN BUFFER CHCD	R/W	0h	There are two power-down masks that are controlled via the PDN mask register bit in address 55h. The power-down mask 1 or mask 2 are selected via register address 26h, bit 5. Power-down mask 1: addresses 20h and 21h. Power-down mask 2: addresses 23h and 24h. See the Power-Down Mode section for details.
5-4	PDN BUFFER CHAB	R/W	0h	
3-0	0	W	0h	Must write 0.

7.6.3.2.5 Register 26h (address = 26h), Master Page (080h)
Figure 94. Register 26h

7	6	5	4	3	2	1	0
GLOBAL PDN	OVERRIDE PDN PIN	PDN MASK SEL	0	0	0	0	0
R/W-0h	R/W-0h	R/W-0h	R/W-0h	R/W-0h	R/W-0h	R/W-0h	R/W-0h

LEGEND: R/W = Read/Write; -n = value after reset

Table 24. Register 26h Field Descriptions

Bit	Field	Type	Reset	Description
7	GLOBAL PDN	R/W	0h	Bit 6 (OVERRIDE PDN PIN) must be set before this bit can be programmed. 0 = Normal operation 1 = Global power-down via the SPI
6	OVERRIDE PDN PIN	R/W	0h	This bit ignores the power-down pin control. 0 = Normal operation 1 = Ignores inputs on the power-down pin
5	PDN MASK SEL	R/W	0h	This bit selects power-down mask 1 or mask 2. 0 = Power-down mask 1 1 = Power-down mask 2
4-0	0	R/W	0h	Must write 0

7.6.3.2.6 Register 3Ah (address = 3Ah) [reset = 0h], Master Page (80h)
Figure 95. Register 3Ah

7	6	5	4	3	2	1	0
0	BUFFER CURR INCREASE	0	0	0	0	0	0
W-0h	R/W-0h	W-0h	W-0h	W-0h	W-0h	W-0h	W-0h

LEGEND: R/W = Read/Write; W = Write only; -n = value after reset

Table 25. Register 3Ah Field Descriptions

Bit	Name	Type	Reset	Description
7	0	W	0h	Must write 0.
6	BUFFER CURR INCREASE	R/W	0h	0 = Normal operation 1 = Increases AVDD3V current by 30 mA., improves HD3, helpful for second Nyquist application. Ensure that the INPUT BUF CUR EN register bit is also set to 1.
5-0	0	W	0h	Must write 0.

7.6.3.2.7 Register 39h (address = 39h) [reset = 0h], Master Page (80h)
Figure 96. Register 39h

7	6	5	4	3	2	1	0
ALWAYS WRITE 1	0	0	0	0	0	0	0
R/W-0h	W-0h	W-0h	W-0h	W-0h	W-0h	W-0h	W-0h

LEGEND: R/W = Read/Write; W = Write only; -n = value after reset

Table 26. Register 39h Field Descriptions

Bit	Name	Type	Reset	Description
7-6	ALWAYS WRITE 1	R/W	0h	Always set these bits to 11.
5-0	0	W	0h	Must write 0.

7.6.3.2.8 Register 53h (address = 53h) [reset = 0h], Master Page (80h)
Figure 97. Register 53h Register

7	6	5	4	3	2	1	0
CLK DIV	MASK SYSREF	0	0	0	0	0	0
R/W-0h	R/W-0h	W-0h	W-0h	W-0h	W-0h	W-0h	W-0h

LEGEND: R/W = Read/Write; -n = value after reset

Table 27. Register 53h Field Descriptions

Bit	Name	Type	Reset	Description
7	CLK DIV	R/W	0h	This bit configures the input clock divider. 0 = Divide-by-4 1 = Divide-by-2 (must be enabled for proper operation of the ADS54J66)
6	MASK SYSREF	R/W	0h	0 = Normal operation 1 = Ignores the SYSREF input
5-0	0	W	0h	Must write 0.

7.6.3.2.9 Register 55h (address = 55h) [reset = 0h], Master Page (80h)
Figure 98. Register 55h

7	6	5	4	3	2	1	0
0	0	0	PDN MASK	0	0	0	0
W-0h	W-0h	W-0h	R/W-0h	W-0h	W-0h	W-0h	W-0h

LEGEND: R/W = Read/Write; W = Write only; -n = value after reset

Table 28. Register 55h Field Descriptions

Bit	Name	Type	Reset	Description
7-5	0	W	0h	Must write 0.
4	PDN MASK	R/W	0h	Power-down via register bit. 0 = Normal operation 1 = Power down enabled powering down internal blocks specified in the selected power-down mask
3-0	0	W	0h	Must write 0.

7.6.3.2.10 Register 56h (address = 56h) [reset = 0h], Master Page (80h)
Figure 99. Register 56h

7	6	5	4	3	2	1	0
0	0	0	0	INPUT BUFF CURR EN	0	0	0
W-0h	W-0h	W-0h	W-0h	R/W-0h	W-0h	W-0h	W-0h

LEGEND: R/W = Read/Write; W = Write only; -n = value after reset

Table 29. Register 56h Field Descriptions

Bit	Name	Type	Reset	Description
7-4	0	W	0h	Must write 0.
3	INPUT BUFF CURR EN	R/W	0h	0 = Normal operation 1 = Increases AVDD3V current by 30 mA., improves HD3, helpful for second Nyquist application. Ensure that the BUFFER CURR INCREASE register bit is also set to 1.
2-0	0	W	0h	Must write 0.

7.6.3.2.11 Register 59h (address = 59h) [reset = 0h], Master Page (80h)
Figure 100. Register 59h

7	6	5	4	3	2	1	0
0	0	ALWAYS WRITE 1	0	0	0	0	0
W-0h	W-0h	R/W-0h	W-0h	W-0h	W-0h	W-0h	W-0h

LEGEND: R/W = Read/Write; W = Write only; -n = value after reset

Table 30. Register 59h Field Descriptions

Bit	Name	Type	Reset	Description
7-6	0	W	0h	Must write 0.
5	ALWAYS WRITE 1	R/W	0h	Always set this bit to 1.
4-0	0	W	0h	Must write 0.

7.6.3.3 ADC Page (0Fh)

7.6.3.3.1 Register 5Fh (address = 5Fh) [reset = 0h], ADC Page (0Fh)

Figure 101. Register 5Fh

7	6	5	4	3	2	1	0
FOVR THRESH							
R/W-0h							

LEGEND: R/W = Read/Write; -n = value after reset

Table 31. Register 5Fh Field Descriptions

Bit	Name	Type	Reset	Description
7-0	FOVR THRESH	R/W	0h	These bits control the location of FAST OVR threshold for all four channels together; see the Overrange Indication section.

7.6.3.3.2 Register 60h (address = 60h) [reset = 0h], ADC Page (0Fh)

Figure 102. Register 60h

7	6	5	4	3	2	1	0
PULSE BIT CHC	0	0	0	0	0	0	0
R/W-0h	W-0h	W-0h	W-0h	W-0h	W-0h	W-0h	W-0h

LEGEND: R/W = Read/Write; W = Write only; -n = value after reset

Table 32. Register 60h Field Descriptions

Bit	Name	Type	Reset	Description
7	PULSE BIT CHC	R/W	0h	Pulse this bit to improve HD3 for 2nd Nyquist frequencies ($f_{IN} > 250$ MHz) for channel C. ⁽¹⁾ Before pulsing this bit, the HD3 NYQ2 CHCD register bit must be set to 1.
6-0	0	W	0h	Must write 0.

(1) Pulsing = set the bit to 1 and then reset to 0.

7.6.3.3.3 Register 61h (address = 61h) [reset = 0h], ADC Page (0Fh)

Figure 103. Register 61h

7	6	5	4	3	2	1	0
0	0	0	0	HD3 NYQ2 CHCD	0	0	PULSE BIT CHD
W-0h	W-0h	W-0h	W-0h	R/W-0h	W-0h	W-0h	R/W-0h

LEGEND: R/W = Read/Write; W = Write only; -n = value after reset

Table 33. Register 61h Field Descriptions

Bit	Name	Type	Reset	Description
7-4	0	W	0h	Must write 0.
3	HD3 NYQ2 CHCD	R/W	0h	Set this bit to improve HD3 for 2nd Nyquist frequencies ($f_{IN} > 250$ MHz) for channel C and D. When this bit is set, the PULSE BIT CHx register bits must be pulsed to obtain the improvement in corresponding channels.
2-1	0	W	0h	Must write 0.
0	PULSE BIT CHD	R/W	0h	Pulse this bit to improve HD3 for 2nd Nyquist frequencies ($f_{IN} > 250$ MHz) for channel D. ⁽¹⁾ Before pulsing this bit, the HD3 NYQ2 CHCD register bit must be set to 1.

(1) Pulsing = set the bit to 1 and then reset to 0.

7.6.3.3.4 Register 6Ch (address = 6Ch) [reset = 0h], ADC Page (0Fh)
Figure 104. Register 6Ch

7	6	5	4	3	2	1	0
PULSE BIT CHA	0	0	0	0	0	0	0
R/W-0h	W-0h	W-0h	W-0h	W-0h	W-0h	W-0h	W-0h

LEGEND: R/W = Read/Write; W = Write only; -n = value after reset

Table 34. Register 6Ch Field Descriptions

Bit	Name	Type	Reset	Description
7	PULSE BIT CHA	R/W	0h	Pulse this bit to improve HD3 for 2nd Nyquist frequencies ($f_{IN} > 250$ MHz) for channel A. ⁽¹⁾ Before pulsing this bit, the HD3 NYQ2 CHCAB register bit must be set to 1.
6-0	0	W	0h	Must write 0.

(1) Pulsing = set the bit to 1 and then reset to 0.

7.6.3.3.5 Register 6Dh (address = 6Dh) [reset = 0h], ADC Page (0Fh)
Figure 105. Register 6Dh

7	6	5	4	3	2	1	0
0	0	0	0	HD3 NYQ2 CHAB	0	0	PULSE BIT CHB
W-0h	W-0h	W-0h	W-0h	R/W-0h	W-0h	W-0h	R/W-0h

LEGEND: R/W = Read/Write; W = Write only; -n = value after reset

Table 35. Register 6Dh Field Descriptions

Bit	Name	Type	Reset	Description
7-4	0	W	0h	Must write 0.
3	HD3 NYQ2 CHAB	R/W	0h	Set this bit to improve HD3 for 2nd Nyquist frequencies ($f_{IN} > 250$ MHz) for channel A and B. When this bit is set, the PULSE BIT CHx register bits must be pulsed to obtain the improvement in corresponding channels.
2-1	0	W	0h	Must write 0.
0	PULSE BIT CHB	R/W	0h	Pulse this bit to improve HD3 for 2nd Nyquist frequencies ($f_{IN} > 250$ MHz) for channel B. ⁽¹⁾ Before pulsing this bit, the HD3 NYQ2 CHAB register bit must be set to 1.

(1) Pulsing = set the bit to 1 and then reset to 0.

7.6.3.3.6 Register 74h (address = 74h) [reset = 0h], ADC Page (0Fh)
Figure 106. Register 74h

7	6	5	4	3	2	1	0
TEST PATTERN ON CHANNEL				0	0	0	0
R/W-0h				W-0h	W-0h	W-0h	W-0h

LEGEND: R/W = Read/Write; -n = value after reset

Table 36. Register 74h Field Descriptions

Bit	Field	Type	Reset	Description
7-4	TEST PATTERN ON CHANNEL	R/W	0h	Test pattern output on channel A and B 0000 = Normal operation using ADC output data 0001 = Outputs all 0s 0010 = Outputs all 1s 0011 = Outputs toggle pattern: Output data are an alternating sequence of 101010101010 and 010101010101 0100 = Output digital ramp: output data increment by one LSB every clock cycle from code 0 to 16384 0110 = Single pattern: output data are custom pattern 1 (75h and 76h) 0111 = Double pattern: output data alternate between custom pattern 1 and custom pattern 2 1000 = Deskew pattern: output data are 2AAAh 1001 = SYNC pattern: output data are 3FFFh See the ADC Test Pattern section for more details.
3-0	0	W	0h	Must write 0.

7.6.3.3.7 Register 75h (address = 75h) [reset = 0h], ADC Page (0Fh)
Figure 107. Register 75h

7	6	5	4	3	2	1	0
CUSTOM PATTERN 1[13:6]							
R/W-0h							

LEGEND: R/W = Read/Write; -n = value after reset

Table 37. Register 75h Field Descriptions

Bit	Name	Type	Reset	Description
7-0	CUSTOM PATTERN	R/W	0h	These bits set the custom pattern (13-6) for all channels; see the ADC Test Pattern section for more details.

7.6.3.3.8 Register 76h (address = 76h) [reset = 0h], ADC Page (0Fh)
Figure 108. Register 76h

7	6	5	4	3	2	1	0
CUSTOM PATTERN 1[5:0]						0	0
R/W-0h						W-0h	W-0h

LEGEND: R/W = Read/Write; W = Write only; -n = value after reset

Table 38. Register 76h Field Descriptions

Bit	Name	Type	Reset	Description
7-2	CUSTOM PATTERN	R/W	0h	These bits set the custom pattern (5-0) for all channels; see the ADC Test Pattern section for more details.
1-0	0	W	0h	Must write 0.

7.6.3.3.9 Register 77h (address = 77h) [reset = 0h], ADC Page (0Fh)
Figure 109. Register 77h

7	6	5	4	3	2	1	0
CUSTOM PATTERN 2[13:6]							
R/W-0h							

LEGEND: R/W = Read/Write; -n = value after reset

Table 39. Register 77h Field Descriptions

Bit	Name	Type	Reset	Description
7-0	CUSTOM PATTERN	R/W	0h	These bits set the custom pattern (13-6) for all channels; see the ADC Test Pattern section for more details.

7.6.3.3.10 Register 78h (address = 78h) [reset = 0h], ADC Page (0Fh)
Figure 110. Register 78h

7	6	5	4	3	2	1	0
CUSTOM PATTERN 2[5:0]						0	0
R/W-0h						W-0h	W-0h

LEGEND: R/W = Read/Write; W = Write only; -n = value after reset

Table 40. Register 78h Field Descriptions

Bit	Name	Type	Reset	Description
7-2	CUSTOM PATTERN	R/W	0h	These bits set the custom pattern (5-0) for all channels; see the ADC Test Pattern section for more details.
1-0	0	W	0h	Must write 0.

7.6.3.4 Interleaving Engine Page (6100h)

7.6.3.4.1 Register 18h (address = 18h) [reset = 0h], Interleaving Engine Page (6100h)

Figure 111. Register 18h

7	6	5	4	3	2	1	0
0	0	0	0	0	0	IL BYPASS	
W-0h	W-0h	W-0h	W-0h	W-0h	W-0h	R/W-0h	

LEGEND: R/W = Read/Write; W = Write only; -n = value after reset

Table 41. Register 18h Field Descriptions

Bit	Name	Type	Reset	Description
7-2	0	W	0h	Must write 0.
1-0	IL BYPASS	R/W	0h	These bits allow bypassing of the interleaving correction, which is to be used when ADC test patterns are enabled. 00 = Interleaving correction enabled 11 = Interleaving correction bypassed

7.6.3.4.2 Register 68h (address = 68h) [reset = 0h], Interleaving Engine Page (6100h)

Figure 112. Register 68h

7	6	5	4	3	2	1	0
0	0	0	0	0	DC CORR DIS		0
W-0h	W-0h	W-0h	W-0h	W-0h	R/W-0h		W-0h

LEGEND: R/W = Read/Write; W = Write only; -n = value after reset

Table 42. Register 68h Field Descriptions

Bit	Name	Type	Reset	Description
7-3	0	W	0h	Must write 0.
2-1	DC CORR DIS	R/W	0h	These bits enable the dc offset correction loop. 00 = DC offset correction enabled 11 = DC offset correction disabled Others = Do not use
0	0	W	0h	Must write 0.

7.6.3.5 Decimation Filter Page (6141h) Registers

7.6.3.5.1 Register 0h (address = 0h) [reset = 0h], Decimation Filter Page (6141h)

Figure 113. Register 0h

7	6	5	4	3	2	1	0
CHB/C FINE MIX				DDC MODE			
R/W-0h				R/W-0h			

LEGEND: R/W = Read/Write; -n = value after reset

Table 43. 0h Field Descriptions

Bit	Field	Type	Reset	Description
7-4	CHB/C FINE MIX	R/W	0h	These bits select fine mixing frequency for the $N \times f_S / 16$ mixer, where N is a twos complement number varying from -8 to 7. 0000 = N is 0 0001 = N is 1 0010 = N is 2 ... 0111 = N is 7 1000 = N is -8 ... 1111 = N is -1
3-0	DDC MODE	R/W	0h	These bits select DDC mode for all channels; see Table 44 for bit settings.

Table 44. DDC MODE Bit Settings

SETTING	MODE	DESCRIPTION
000	0	$f_S / 4$ mixing with decimation-by-2, complex output
001	–	N/A
010	2	Decimation-by-2, high or low pass filter, real output
011	–	N/A
100	4	Decimation-by-2, $N \times f_S / 16$ mixer, real output
101	5	Decimation-by-2, $N \times f_S / 16$ mixer, complex output
110	6	Decimation-by-4, $N \times f_S / 16$ mixer, complex output. Ensure that the DDC MODE 6 EN[3:1] register bits are also set to 111.
111	7	Decimation-by-2, $N \times f_S / 16$ mixer, insert 0, real output
1000	8	No decimation, no mixing, straight 500-MSPS data output
Others	–	Do not use

7.6.3.5.2 Register 1h (address = 1h) [reset = 0h], Decimation Filter Page (6141h)
Figure 114. Register 1h

7	6	5	4	3	2	1	0
0	0	0	0	DDC MODE6 EN1	ALWAYS WRITE 1	CHB/C HPF EN	CHB/C COARSE MIX
W-0h	W-0h	W-0h	W-0h	R/W-0h	R/W-0h	R/W-0h	R/W-0h

LEGEND: R/W = Read/Write; W = Write only; -n = value after reset

Table 45. Register 1h Field Descriptions

Bit	Name	Type	Reset	Description
7-4	0	W	0h	Must write 0.
3	DDC MODE6 EN1	R/W	0h	Set this bit along with the DDC MODE6 EN2 and DDC MODE6 EN3 register bits for proper operation of mode 6. 0 = Default 1 = Use for proper operation of DDC mode 6
2	ALWAYS WRITE 1	R/W	0h	Always write this bit to 1.
1	CHB/C HPF EN	R/W	0h	This bit enables the high-pass filter for DDC mode 2 for channel B and C. 0 = Low-pass filter enabled 1 = High-pass filter enabled
0	CHB/C COARSE MIX	R/W	0h	This bit selects the $f_S / 4$ mixer phase for DDC mode 0 for channel B and C. 0 = Mix with $f_S / 4$ 1 = Mix with $-f_S / 4$

7.6.3.5.3 Register 2h (address = 2h) [reset = 0h], Decimation Filter Page (6141h)
Figure 115. Register 2h

7	6	5	4	3	2	1	0
0	0	CHA/D HPF EN	CHA/D COARSE MIX	CHA/D FINE MIX			
W-0h	W-0h	R/W-0h	R/W-0h	R/W-0h			

LEGEND: R/W = Read/Write; W = Write only; -n = value after reset

Table 46. 2h Field Descriptions

Bit	Name	Type	Reset	Description
7-6	0	W	0h	Must write 0.
5	CHA/D HPF EN	R/W	0h	This bit enables the high-pass filter for DDC mode 2 for channel A and D. 0 = Low-pass filter enabled 1 = High-pass filter enabled
4	CHA/D COARSE MIX	R/W	0h	This bit selects the $f_S / 4$ mixer phase for DDC mode 0 for channel A and D. 0 = Mix with $f_S / 4$ 1 = Mix with $-f_S / 4$
3-0	CHA/D FINE MIX	R/W	0h	These bits select the fine mixing frequency for the $N \times f_S / 16$ mixer, where N is a two's complement number varying from -8 to 7. 0000 = N is 0 0001 = N is 1 0010 = N is 2 ... 0111 = N is 7 1000 = N is -8 ... 1111 = N is -1

7.6.3.6 Main Digital Page (6800h) Registers

7.6.3.6.1 Register 0h (address = 0h) [reset = 0h], Main Digital Page (6800h)

Figure 116. Register 0h

7	6	5	4	3	2	1	0
0	0	0	0	0	0	0	IL RESET
W-0h	W-0h	W-0h	W-0h	W-0h	W-0h	W-0h	R/W-0h

LEGEND: R/W = Read/Write; W = Write only; -n = value after reset

Table 47. Register 0h Field Descriptions

Bit	Name	Type	Reset	Description
7-1	0	W	0h	Must write 0.
0	IL RESET	R/W	0h	This bit resets the interleaving engine. This bit is not a self-clearing bit and must be pulsed ⁽¹⁾ . Any register bit in the main digital page (6800h) takes effect only after this bit is pulsed. Also, note that pulsing this bit clears registers in the interleaving page (6100h). 0 = Normal operation 0 → 1 → 0 = Interleaving engine reset

(1) Pulsing = set the bit to 1 and then reset to 0.

7.6.3.6.2 Register 42h (address = 42h) [reset = 0h], Main Digital Page (6800h)

Figure 117. Register 42h

7	6	5	4	3	2	1	0
0	0	0	0	0	NYQUIST ZONE		
W-0h	W-0h	W-0h	W-0h	W-0h	R/W-0h		

LEGEND: R/W = Read/Write; W = Write only; -n = value after reset

Table 48. Register 42h Field Descriptions

Bit	Name	Type	Reset	Description
7-3	0	W	0h	Must write 0.
2-0	NYQUIST ZONE	R/W	0h	These bits provide Nyquist zone information to the interleaving engine. Ensure that the CTRL NYQUIST register bit is set to 1. 000 = 1 st Nyquist zone (input frequencies between 0 to $f_s / 2$) 001 = 2 nd Nyquist zone (input frequencies between $f_s / 2$ to f_s) 010 = 3 rd Nyquist zone (input frequencies between f_s to $3 f_s / 2$) ... 111 = 8 th Nyquist zone (input frequencies between $7 f_s / 2$ to $4 f_s$)

7.6.3.6.3 Register 4Eh (address = 4Eh) [reset = 0h], Main Digital Page (6800h)

Figure 118. Register 4Eh

7	6	5	4	3	2	1	0
CTRL NYQUIST	0	0	0	0	0	0	0
R/W-0h	W-0h	W-0h	W-0h	W-0h	W-0h	W-0h	W-0h

LEGEND: R/W = Read/Write; W = Write only; -n = value after reset

Table 49. Register 4Eh Field Descriptions

Bit	Name	Type	Reset	Description
7	CTRL NYQUIST	R/W	0h	Enables Nyquist zone control using register bits NYQUIST ZONE. 0 = Selection disabled 1 = Selection enabled
6-0	0	W	0h	Must write 0.

7.6.3.6.4 Register ABh (address = ABh) [reset = 0h], Main Digital Page (6800h)
Figure 119. Register ABh

7	6	5	4	3	2	1	0
0	0	0	0	0	0	0	OVR EN
W-0h	W-0h	W-0h	W-0h	W-0h	W-0h	W-0h	R/W-0h

LEGEND: R/W = Read/Write; W = Write only; -n = value after reset

Table 50. Register ABh Field Descriptions

Bit	Field	Type	Reset	Description
7-1	0	W	0h	Must write 0.
0	OVR EN	R/W	0h	Set this bit to enable the OVR ON LSB register bit. 0 = Normal operation 1 = OVR ON LSB enabled

7.6.3.6.5 Register ADh (address = ADh) [reset = 0h], Main Digital Page (6800h)
Figure 120. Register ADh

7	6	5	4	3	2	1	0
0	0	0	0	OVR ON LSB			
W-0h	W-0h	W-0h	W-0h	R/W-0h			

LEGEND: R/W = Read/Write; W = Write only; -n = value after reset

Table 51. Register ADh Field Descriptions

Bit	Field	Type	Reset	Description
7-4	0	W	0h	Must write 0.
3-0	OVR EN	R/W	0h	Set this bit to bring OVR on two LSBs of the 16-bit output. Ensure that the OVR EN register bit is set to 1. 0000 = Bits 0 and 1 of the 16-bit data are noise bits 0011 = OVR comes on bit 0 of the 16-bit data 1100 = OVR comes on bit 1 of the 16-bit data 1111 = OVR comes on both bits 0 and 1 of the 16-bit data

7.6.3.6.6 Register F7h (address = F7h) [reset = 0h], Main Digital Page (68h)
Figure 121. Register F7h

7	6	5	4	3	2	1	0
0	0	0	0	0	0	0	DIG RESET
W-0h	W-0h	W-0h	W-0h	W-0h	W-0h	W-0h	R/W-0h

LEGEND: R/W = Read/Write; W = Write only; -n = value after reset

Table 52. Register F7h Field Descriptions

Bit	Field	Type	Reset	Description
7-1	0	W	0h	Must write 0.
0	DIG RESET	R/W	0h	Self-clearing reset for the digital block. Does not include the interleaving correction. 0 = Normal operation 1 = Digital reset

7.6.3.7 JESD Digital Page (6900h) Registers

7.6.3.7.1 Register 0h (address = 0h) [reset = 0h], JESD Digital Page (6900h)

Figure 122. Register 0h

7	6	5	4	3	2	1	0
CTRL K	JESD MODE EN	DDC MODE6 EN2	TESTMODE EN	0	LANE ALIGN	FRAME ALIGN	TX LINK DIS
R/W-0h	R/W-0h	R/W-0h	R/W-0h	W-0h	R/W-0h	R/W-0h	R/W-0h

LEGEND: R/W = Read/Write; W = Write only; -n = value after reset

Table 53. Register 0h Field Descriptions

Bit	Name	Type	Reset	Description
7	CTRL K	R/W	0h	Enable bit for a number of frames per multi frame. 0 = Default is five frames per multi frame 1 = Frames per multi frame can be set in register 06h
6	JESD MODE EN	R/W	0h	Allows changing the JESD MODE setting in register 01h (bits 1-0) 0 = Disabled 1 = Enables changing the JESD MODE setting
5	DDC MODE6 EN2	R/W	0h	Set this bit along with the DDC MODE6 EN1 and DDC MODE6 EN3 register bits for proper operation of mode 6. 0 = Default 1 = Use for proper operation of DDC mode 6
4	TESTMODE EN	R/W	0h	This bit generates the long transport layer test pattern mode, as per section 5.1.6.3 of the JESD204B specification. 0 = Test mode disabled 1 = Test mode enabled
3	0	W	0h	Must write 0.
2	LANE ALIGN	R/W	0h	This bit inserts the lane alignment character (K28.3) for the receiver to align to lane boundary, as per section 5.3.3.5 of the JESD204B specification. 0 = Normal operation 1 = Inserts lane alignment characters
1	FRAME ALIGN	R/W	0h	This bit inserts the lane alignment character (K28.7) for the receiver to align to lane boundary, as per section 5.3.3.5 of the JESD204B specification. 0 = Normal operation 1 = Inserts frame alignment characters
0	TX LINK DIS	R/W	0h	This bit disables sending the initial link alignment (ILA) sequence when SYNC is de-asserted. 0 = Normal operation 1 = ILA disabled

7.6.3.7.2 Register 1h (address = 1h) [reset = 0h], JESD Digital Page (6900h)
Figure 123. Register 1h

7	6	5	4	3	2	1	0
SYNC REG	SYNC REG EN	SYNCB SEL AB/CD	0	DDC MODE6 EN3	0	JESD MODE	
R/W-0h	R/W-0h	R/W-0h	W-0h	R/W-0h	W-0h	R/W-0h	

LEGEND: R/W = Read/Write; W = Write only; -n = value after reset

Table 54. Register 1h Field Descriptions

Bit	Name	Type	Reset	Description
7	SYNC REG	R/W	0h	SYNC register (bit 6 must be enabled). 0 = Normal operation 1 = ADC output data are replaced with K28.5 characters
6	SYNC REG EN	R/W	0h	Enables bit for SYNC operation. 0 = Normal operation 1 = ADC output data overwrite enabled
5	SYNCB SEL AB/CD	R/W	0h	This bit selects which SYNCb input controls the JESD interface; must be configured for ch AB and ch CD. 0 = SYNCbAB 1 = SYNCbCD
4	0	W	0h	Must write 0.
3	DDC MODE6 EN3	R/W	0h	Set this bit along with the DDC MODE6 EN1 and DDC MODE6 EN2 register bits for proper operation of mode 6. 0 = Default 1 = Use for proper operation of DDC mode 6
2	0	W	0h	Must write 0.
1-0	JESD MODE	R/W	0h	These bits select the number of serial JESD output lanes per ADC. The JESD MODE EN (00h) and JESD PLL MODE register (JESD ANALOG page, register 16h) must also be set accordingly. 01 = 20x mode 10 = 40x mode 11 = 80x mode All others = Not used

7.6.3.7.3 Register 2h (address = 2h) [reset = 0h], JESD Digital Page (6900h)

Figure 124. Register 2h

7	6	5	4	3	2	1	0
LINK LAYER TESTMODE			LINK LAYER RPAT	LMFC MASK RESET	0	0	0
R/W-0h			R/W-0h	R/W-0h	W-0h	W-0h	W-0h

LEGEND: R/W = Read/Write; W = Write only; -n = value after reset

Table 55. Register 2h Field Descriptions

Bit	Name	Type	Reset	Description
7-5	LINK LAYER TESTMODE	R/W	0h	These bits generate a pattern according to clause 5.3.3.8.2 of the JESD204B document. 000 = Normal ADC data 001 = D21.5 (high-frequency jitter pattern) 010 = K28.5 (mixed-frequency jitter pattern) 011 = Repeat initial lane alignment (generates a K28.5 character and continuously repeats lane alignment sequences) 100 = 12-octet RPAT jitter pattern
4	LINK LAYER RPAT	R/W	0h	This bit changes the running disparity in the modified RPAT pattern test mode (only when the link layer test mode = 100). 0 = Normal operation 1 = Changes disparity
3	LMFC MASK RESET	R/W	0h	0 = Default 1 = Resets the LMFC mask
2-0	0	W	0h	Must write 0.

7.6.3.7.4 Register 3h (address = 3h) [reset = 0h], JESD Digital Page (6900h)

Figure 125. Register 3h

7	6	5	4	3	2	1	0
FORCE LMFC COUNT		LMFC COUNT INIT				RELEASE ILANE SEQ	
R/W-0h		R/W-0h				R/W-0h	

LEGEND: R/W = Read/Write; -n = value after reset

Table 56. Register 3h Field Descriptions

Bit	Name	Type	Reset	Description
7	FORCE LMFC COUNT	R/W	0h	This bit forces the LMFC count. 0 = Normal operation 1 = Enables using a different starting value for the LMFC counter
6-2	LMFC COUNT INIT	R/W	0h	SYSREF coming to the digital block resets the LMFC count to 0 and K28.5 stops coming when the LMFC count reaches 31. The initial value that the LMFC count resets to can be set using LMFC COUNT INIT. In this manner, Rx can be synchronized early because it receives the LANE ALIGNMENT SEQUENCE early. The FORCE LMFC COUNT register bit must be enabled.
1-0	RELEASE ILANE SEQ	R/W	0h	These bits delay the generation of lane alignment sequence by 0, 1, 2, or 3 multi frames after code group synchronization. 00 = 0 01 = 1 10 = 2 11 = 3

7.6.3.7.5 Register 5h (address = 5h) [reset = 0h], JESD Digital Page (6900h)
Figure 126. Register 5h

7	6	5	4	3	2	1	0
SCRAMBLE EN	0	0	0	0	0	0	0
R/W-0h	W-0h	W-0h	W-0h	W-0h	W-0h	W-0h	W-0h

LEGEND: R/W = Read/Write; W = Write only; -n = value after reset

Table 57. Register 5h Field Descriptions

Bit	Name	Type	Reset	Description
7	SCRAMBLE EN	R/W	0h	Scramble enable bit in the JESD204B interface. 0 = Scrambling disabled 1 = Scrambling enabled
6-0	0	W	0h	Must write 0.

7.6.3.7.6 Register 6h (address = 6h) [reset = 0h], JESD Digital Page (6900h)
Figure 127. Register 6h

7	6	5	4	3	2	1	0
0	0	0	FRAMES PER MULTI FRAME (K)				
W-0h	W-0h	W-0h	R/W-0h				

LEGEND: R/W = Read/Write; W = Write only; -n = value after reset

Table 58. Register 6h Field Descriptions

Bit	Name	Type	Reset	Description
7-5	0	W	0h	Must write 0.
4-0	FRAMES PER MULTI FRAME (K)	R/W	0h	These bits set the number of multi frames. Actual K is the value in hex + 1 (that is, 0Fh is K = 16).

7.6.3.7.7 Register 19h (address = 19h) [reset = 0h], JESD Digital Page (6900h)
Figure 128. Register 19h

7	6	5	4	3	2	1	0
0	0	0	0	LC[27:24]			
W-0h	W-0h	W-0h	W-0h	R/W-0h			

LEGEND: R/W = Read/Write; W = Write only; -n = value after reset

Table 59. Register 19h Field Descriptions

Bit	Name	Type	Reset	Description
7-4	0	W	0h	Must write 0.
3-0	LC[27:24]	R/W	0h	These bits set the low resolution counter value. When programming LC[27:0], first program LC[7:0], then LC[15:8], then LC[23:16], and then LC[27:24] in the same order.

7.6.3.7.8 Register 1Ah (address = 1Ah) [reset = 0h], JESD Digital Page (6900h)
Figure 129. Register 1Ah

7	6	5	4	3	2	1	0
LC[23:16]							
R/W-0h							

LEGEND: R/W = Read/Write; -n = value after reset

Table 60. 1Ah Field Descriptions

Bit	Name	Type	Reset	Description
7-0	LC[23:16]	R/W	0h	These bits set the low resolution counter value. When programming LC[27:0], first program LC[7:0], then LC[15:8], then LC[23:16], and then LC[27:24] in the same order.

7.6.3.7.9 Register 1Bh (address = 1Bh) [reset = 0h], JESD Digital Page (6900h)
Figure 130. Register 1Bh

7	6	5	4	3	2	1	0
LC[15:8]							
R/W-0h							

LEGEND: R/W = Read/Write; -n = value after reset

Table 61. Register 1Bh Field Descriptions

Bit	Name	Type	Reset	Description
7-0	LC[15:8]	R/W	0h	These bits set the low resolution counter value. When programming LC[27:0], first program LC[7:0], then LC[15:8], then LC[23:16], and then LC[27:24] in the same order.

7.6.3.7.10 Register 1Ch (address = 1Ch) [reset = 0h], JESD Digital Page (6900h)
Figure 131. Register 1Ch

7	6	5	4	3	2	1	0
LC[7:0]							
R/W-0h							

LEGEND: R/W = Read/Write; -n = value after reset

Table 62. Register 1Ch Field Descriptions

Bit	Name	Type	Reset	Description
7-0	LC[7:0]	R/W	0h	These bits set the low resolution counter value. When programming LC[27:0], first program LC[7:0], then LC[15:8], then LC[23:16], and then LC[27:24] in the same order.

7.6.3.7.11 Register 1Dh (address = 1Dh) [reset = 0h], JESD Digital Page (6900h)
Figure 132. Register 1Dh

7	6	5	4	3	2	1	0
0	0	0	0	HC[27:24]			
W-0h	W-0h	W-0h	W-0h	R/W-0h			

LEGEND: R/W = Read/Write; W = Write only; -n = value after reset

Table 63. Register 1Dh Field Descriptions

Bit	Name	Type	Reset	Description
7-4	0	W	0h	Must write 0.
3-0	HC [xx:xx]	R/W	0h	These bits set the high resolution counter value. When programming HC[27:0], first program HC[7:0], then HC[15:8], then HC[23:16], and then HC[27:24] in the same order.

7.6.3.7.12 Register 1Eh (address = 1Eh) [reset = 0h], JESD Digital Page (6900h)
Figure 133. Register 1Eh

7	6	5	4	3	2	1	0
HC[23:16]							
R/W-0h							

LEGEND: R/W = Read/Write; -n = value after reset

Table 64. Register 1Eh Field Descriptions

Bit	Name	Type	Reset	Description
7-0	HC[23:16]	R/W	0h	These bits set the high resolution counter value. When programming HC[27:0], first program HC[7:0], then HC[15:8], then HC[23:16], and then HC[27:24] in the same order.

7.6.3.7.13 Register 1Fh (address = 1Fh) [reset = 0h], JESD Digital Page (6900h)
Figure 134. Register 1Fh

7	6	5	4	3	2	1	0
HC[15:8]							
R/W-0h							

LEGEND: R/W = Read/Write; -n = value after reset

Table 65. Register 1Fh Field Descriptions

Bit	Name	Type	Reset	Description
7-0	HC[15:8]	R/W	0h	These bits set the high resolution counter value. When programming HC[27:0], first program HC[7:0], then HC[15:8], then HC[23:16], and then HC[27:24] in the same order.

7.6.3.7.14 Register 20h (address = 20h) [reset = 0h], JESD Digital Page (6900h)
Figure 135. Register 20h

7	6	5	4	3	2	1	0
HC[7:0]							
R/W-0h							

LEGEND: R/W = Read/Write; -n = value after reset

Table 66. Register 20h Field Descriptions

Bit	Name	Type	Reset	Description
7-0	HC[7:0]	R/W	0h	These bits set the high resolution counter value. When programming HC[27:0], first program HC[7:0], then HC[15:8], then HC[23:16], and then HC[27:24] in the same order.

7.6.3.7.15 Register 21h (address = 21h) [reset = 0h], JESD Digital Page (6900h)
Figure 136. Register 21h

7	6	5	4	3	2	1	0
OUTPUT CHA MUX SEL		OUTPUT CHB MUX SEL		OUTPUT CHC MUX SEL		OUTPUT CHD MUX SEL	
R/W-0h		R/W-0h		R/W-0h		R/W-0h	

LEGEND: R/W = Read/Write; -n = value after reset

Table 67. 21h Field Descriptions

Bit	Name	Type	Reset	Description
7-6	OUTPUT CHA MUX SEL	R/W	0h	SERDES lane swap with ch B. 00 = Ch A is output on lane DA 10 = Ch A is output on lane DB 01, 11 = Do not use
5-4	OUTPUT CHB MUX SEL	R/W	0h	SERDES lane swap with ch A. 00 = Ch B is output on lane DB 10 = Ch B is output on lane DA 01, 11 = Do not use
3-2	OUTPUT CHC MUX SEL	R/W	0h	SERDES lane swap with ch D. 00 = Ch C is output on lane DC 10 = Ch C is output on lane DD 01, 11 = Do not use
1-0	OUTPUT CHD MUX SEL	R/W	0h	SERDES lane swap with ch C. 00 = Ch D is output on lane DD 10 = Ch D is output on lane DC 01, 11 = Do not use

7.6.3.7.16 Register 22h (address = 22h) [reset = 0h], JESD Digital Page (6900h)
Figure 137. Register 22h

7	6	5	4	3	2	1	0
0	0	0	0	OUT CHA INV	OUT CHB INV	OUT CHC INV	OUT CHD INV
W-0h	W-0h	W-0h	W-0h	R/W-0h	R/W-0h	R/W-0h	R/W-0h

LEGEND: R/W = Read/Write; W = Write only; -n = value after reset

Table 68. 22h Field Descriptions

Bit	Name	Type	Reset	Description
7-4	0	W	0h	Must write 0.
3	OUT CHA INV	R/W	0h	Polarity inversion of JESD output of ch A. 0 = Normal operation 1 = Output polarity inverted
2	OUT CHB INV	R/W	0h	Polarity inversion of JESD output of ch B. 0 = Normal operation 1 = Output polarity inverted
1	OUT CHC INV	R/W	0h	Polarity inversion of JESD output of ch C. 0 = Normal operation 1 = Output polarity inverted
0	OUT CHD INV	R/W	0h	Polarity inversion of JESD output of ch D. 0 = Normal operation 1 = Output polarity inverted

7.6.3.8 JESD Analog Page (6A00h) Register
7.6.3.8.1 Register 12h, 13h (address 12h, 13h) [reset = 0h], JESD Analog Page (6Ah)
Figure 138. Register 12h

7	6	5	4	3	2	1	0
SEL EMP LANE DA/DD						0	0
R/W-0h						W-0h	W-0h

LEGEND: R/W = Read/Write; W = Write only; -n = value after reset

Figure 139. Register 13h

7	6	5	4	3	2	1	0
SEL EMP LANE DB/DC						0	0
R/W-0h						W-0h	W-0h

LEGEND: R/W = Read/Write; W = Write only; -n = value after reset

Table 69. 12h, 13h Field Descriptions

Bit	Name	Type	Reset	Description
7-2	SEL EMP LANE DA/DD SEL EMP LANE DB/DC	R/W	0h	Selects the amount of de-emphasis for the JESD output transmitter. The de-emphasis value in dB is measured as the ratio between the peak value after the signal transition to the settled value of the voltage in one bit period. 0 = 0 dB 1 = -1 dB 3 = -2 dB 7 = -4.1 dB 15 = -6.2 dB 31 = -8.2 dB 63 = -11.5 dB
1-0	0	W	0h	Must write 0.

7.6.3.8.2 16h (address = 16h) [reset = 0h], JESD Analog Page (6A00h)
Figure 140. Register 16h

7	6	5	4	3	2	1	0
0	0	0	0	0	0	JESD PLL MODE	
W-0h	W-0h	W-0h	W-0h	W-0h	W-0h	R/W-0h	

LEGEND: R/W = Read/Write; W = Write only; -n = value after reset

Table 70. 16h Field Descriptions

Bit	Name	Type	Reset	Description
7-1	0	W	0h	Must write 0.
0	JESD PLL MODE	R/W	0h	This bit selects the JESD PLL multiplication factor. 0 = 20x mode 1 = 40x mode

7.6.3.8.3 Register 1Bh (address = 1Bh) [reset = 0h], JESD Analog Page (6Ah)
Figure 141. Register 1Bh

7	6	5	4	3	2	1	0
JESD SWING			0	0	0	0	0
R/W-0h			W-0h	W-0h	W-0h	W-0h	W-0h

LEGEND: R/W = Read/Write; W = Write only; -n = value after reset

Table 71. 1Bh Field Descriptions

Bit	Name	Type	Reset	Description
7-5	JESD SWING	R/W	0h	This bit programs the SERDES output swing. 0 = 860 mV _{PP} 1 = 810 mV _{PP} 2 = 770 mV _{PP} 3 = 745 mV _{PP} 4 = 960 mV _{PP} 5 = 930 mV _{PP} 6 = 905 mV _{PP} 7 = 880 mV _{PP}
4-3	0	W	0h	Must write 0.

8 Application and Implementation

NOTE

Information in the following applications sections is not part of the TI component specification, and TI does not warrant its accuracy or completeness. TI's customers are responsible for determining suitability of components for their purposes. Customers should validate and test their design implementation to confirm system functionality.

8.1 Application Information

8.1.1 Start-Up Sequence

The following steps are recommended as the power-up sequence with the ADS54J66 in DDC mode 8 (no decimation) with LMFS = 4421 (shown in [Table 72](#)).

Table 72. Recommended Power-Up Sequence

STEP	DESCRIPTION	REGISTER ADDRESS	REGISTER DATA	COMMENT
1	Supply all supply voltages. There is no required power supply sequence for the 1.15-V supply, 1.9-V supply, and 3-V supply, and they can be supplied in any order.	—	—	—
2	Pulse a hardware reset (low to high to low) on pin 48. Alternatively, the device can be reset with an analog reset and a digital reset.	—	—	—
		0000h 4004h 4003h 4002h 4001h 60F7h 60F7h 70F7h 70F7h	81h 68h 00h 00h 00h 01h 00h 01h 00h	—
3	Set the input clock divider.	0011h 0053h 0039h 0059h	80h 80h C0h 20h	Select the master page in the analog bank. Set the clock divider to divide-by-2. Set the ALWAYS WRITE 1 bit for all channels. Set the ALWAYS WRITE 1 bit for all channels.
4	Reset the interleaving correction engine in register 6800h of the main digital page of the JESD bank. (Register access is already set to page 6800h in step 2.)	6000h 6000h 7000h 7000h	01h 00h 01h 00h	Resets the interleaving engine for channel A, B (because the device is in broadcast mode). Resets the interleaving engine for channel C, D (because the device is in broadcast mode).
5	Set DDC mode 8 for all channels (no decimation, 14-bit, 500-MSPS data output).	4004h 4003h 6000h 7000h 6001h 7001h	61h 41h 08h 08h 04h 04h	Select the decimation filter page of the JESD bank. Select DDC mode 8 for channel A, B. Select DDC mode 8 for channel C, D. Set the ALWAYS WRITE 1 bit for channel A, B. Set the ALWAYS WRITE 1 bit for channel C, D.
6	Default registers for the analog page of the JESD bank.	4003h 4004h 6016h 7016h	00h 6Ah 02h 02h	Select the analog page in the JESD bank. PLL mode 40x for channel A, B. PLL mode 40x for channel C, D.

Application Information (continued)

Table 72. Recommended Power-Up Sequence (continued)

STEP	DESCRIPTION	REGISTER ADDRESS	REGISTER DATA	COMMENT
7	Default registers for the digital page of the JESD bank.	4003h 4004h 6000h 6001h 7000h 7001h 6000h 6006h 7000h 7006h	00h 69h 20h 01h 20h 01h 80h 0Fh 80h 0Fh	Select the digital page in the JESD bank. Enable JESD MODE control for channel A, B. Set JESD MODE to 20x mode for LMFS = 4421. Enable JESD MODE control for channel C, D. Set JESD MODE to 20x mode for LMFS = 4421. Set CTRL K for channel A, B. Set K to 16. Set CTRL K for channel C, D. Set K to 16.
8	Enable a single SYNCb input (on the SYNCbAB pin).	4005h 7001h	01h 20h	Disable broadcast mode. Use SYNCbABP, SYNCbABM to issue a SYNC request for all four channels.
9	Pulse SYNCbAB (pins 55 and 56) from high to low.	—	—	K28.5 characters are transmitted by all four channels (CGS phase).
10	Pulse SYNCbAB (pins 55 and 56) from low to high.	—	—	The ILA sequence begins and lasts for four multiframe. The device transmits ADC data after the ILA sequence ends.

8.1.2 Hardware Reset

8.1.2.1 Register Initialization

After power-up, the internal registers can be initialized to their default values through a hardware reset by applying a high pulse on the RESET pin (of durations greater than 10 ns), as shown in Figure 142. Alternatively, the serial interface registers can be cleared a set of register writes as described in the *Start-Up Sequence* section. Table 73 lists the timing requirements for the pulse signal on the RESET pin.

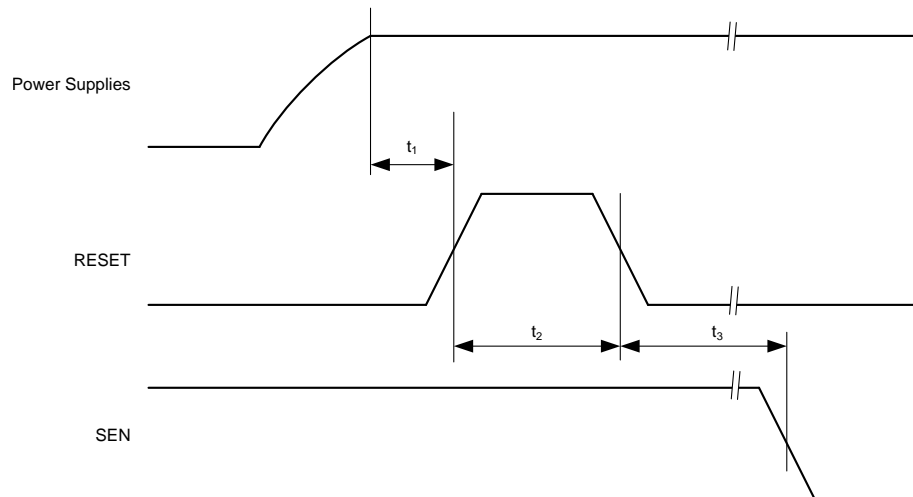

Figure 142. Hardware Reset Timing Diagram

Table 73. Timing Requirements for Hardware Reset

		MIN	TYP	MAX	UNIT
t ₁	Power-on delay from power-up to active high RESET pulse	1			ms
t ₂	Reset pulse duration : active high RESET pulse duration	10			ns
t ₃	Register write delay from RESET disable to SEN active	100			ns

8.1.3 SNR and Clock Jitter

The signal-to-noise ratio of the ADC is limited by three different factors (as shown in Equation 2): the quantization noise is typically not noticeable in pipeline converters and is 84 dB for a 14-bit ADC. The thermal noise limits the SNR at low input frequencies and the clock jitter sets the SNR for higher input frequencies.

$$SNR_{ADC}[dBc] = -20\log \sqrt{\left(10^{-\frac{SNR_{Quantization\ Noise}}{20}}\right)^2 + \left(10^{-\frac{SNR_{Thermal\ Noise}}{20}}\right)^2 + \left(10^{-\frac{SNR_{Jitter}}{20}}\right)^2} \tag{2}$$

The SNR limitation resulting from sample clock jitter can be calculated by Equation 3:

$$SNR_{jitter}[dBc] = -20\log(2\pi \times f_{in} \times T_{jitter}) \tag{3}$$

The total clock jitter (T_{jitter}) has two components: the internal aperture jitter (120 fs for the ADS54J66) that is set by the noise of the clock input buffer and the external clock jitter. T_{jitter} can be calculated by Equation 4:

$$T_{jitter} = \sqrt{(T_{jitter, Ext_Clock_Input})^2 + (T_{Aperture_ADC})^2} \tag{4}$$

External clock jitter can be minimized by using high-quality clock sources and jitter cleaners as well as band-pass filters at the clock input; a faster clock slew rate also improves the ADC aperture jitter.

The ADS54J66 has a thermal noise of approximately 72 dBFS and an internal aperture jitter of 120 fs.

8.1.4 ADC Test Pattern

The ADS54J66 provides several different options to output test patterns instead of the actual output data of the ADC in order to simplify bring up of the JESD204B digital interface link. The output data path is shown in Figure 143.

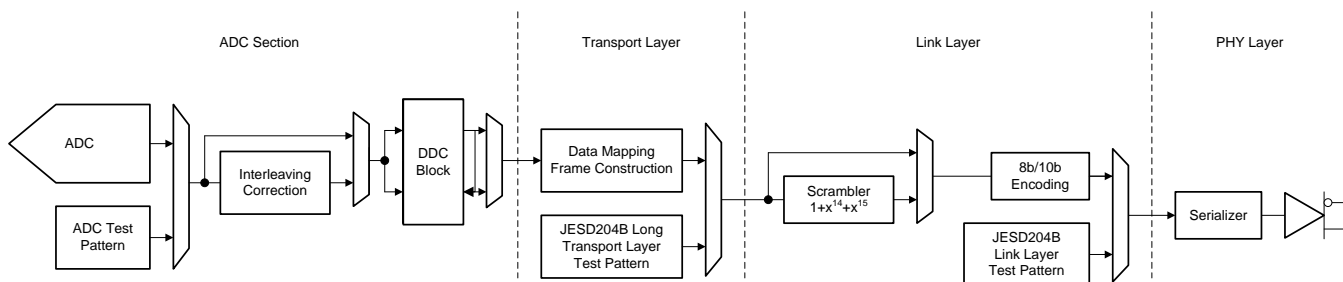

Figure 143. ADC Test Pattern

8.1.4.1 ADC Section

The ADC test pattern replaces the actual output data of the ADC. The following test patterns are available in register 74h. In order to properly obtain the test pattern output, the interleaving correction must be disabled (6100h, address 18h) and DDC mode-8 must be selected (un-decimated output).

In un-decimated output (DDC mode-8), the device supports LMFS = 4421 only. Available ADC test patterns are summarized in [Table 74](#).

Table 74. ADC Test Pattern Settings

BIT	NAME	DEFAULT	DESCRIPTION
7-4	TEST PATTERN	0000	These bits provide the test pattern output on channels A and B. 0000 = Normal operation using ADC output data 0001 = Outputs all 0s 0010 = Outputs all 1s 0011 = Outputs toggle pattern: output data are an alternating sequence of 101010101010 and 010101010101 0100 = Output digital ramp: output data increment by one LSB every clock cycle from code 0 to 16384 0110 = Single pattern: output data are custom pattern 1 (75h and 76h) 0111 = Double pattern: output data alternate between custom pattern 1 and custom pattern 2 1000 = Deskew pattern: output data are 2AAAh 1001 = SYNC pattern: output data are 3FFFh

8.1.4.2 Transport Layer Pattern

The transport layer maps the ADC output data into 8-bit octets and constructs the JESD204B frames using the LMFS parameters. Tail bits or 0s are added when needed. Alternatively, the JESD204B long transport layer test pattern can be substituted as shown in [Table 75](#).

Table 75. Transport Layer Test Mode

BIT	NAME	DEFAULT	DESCRIPTION
4	TESTMODE EN	0	This bit generates the long transport layer test pattern mode according to clause 5.1.6.3 of the JESD204B specification. 0 = Test mode disabled 1 = Test mode enabled

8.1.4.3 Link Layer Pattern

The link layer contains the scrambler and the 8b/10b encoding of any data passed on from the transport layer. Additionally, the link layer also handles the initial lane alignment sequence that can be manually restarted. The link layer test patterns are intended for testing the quality of the link (jitter testing and so forth). The test patterns do not pass through the 8b/10b encoder and contain the options shown in [Table 76](#).

Table 76. Link Layer Test Mode

BIT	NAME	DEFAULT	DESCRIPTION
7-5	LINK LAYER TESTMODE	000	These bits generate the pattern according to clause 5.3.3.8.2 of the JESD204B document. 000 = Normal ADC data 001 = D21.5 (high-frequency jitter pattern) 010 = K28.5 (mixed-frequency jitter pattern) 011 = Repeat initial lane alignment (generates a K28.5 character and repeats lane alignment sequences continuously) 100 = 12-octet RPAT jitter pattern

Furthermore, a 2¹⁵ PRBS can be enabled by setting up a custom test pattern (AAAA) in the ADC section and running that through the 8b/10b encoder with scrambling enabled.

8.2 Typical Application

The ADS54J66 is designed for wideband receiver applications demanding excellent dynamic range over a large input frequency range. A typical schematic for an ac-coupled dual receiver (dual FPGA with dual SYNC) is shown in Figure 144.

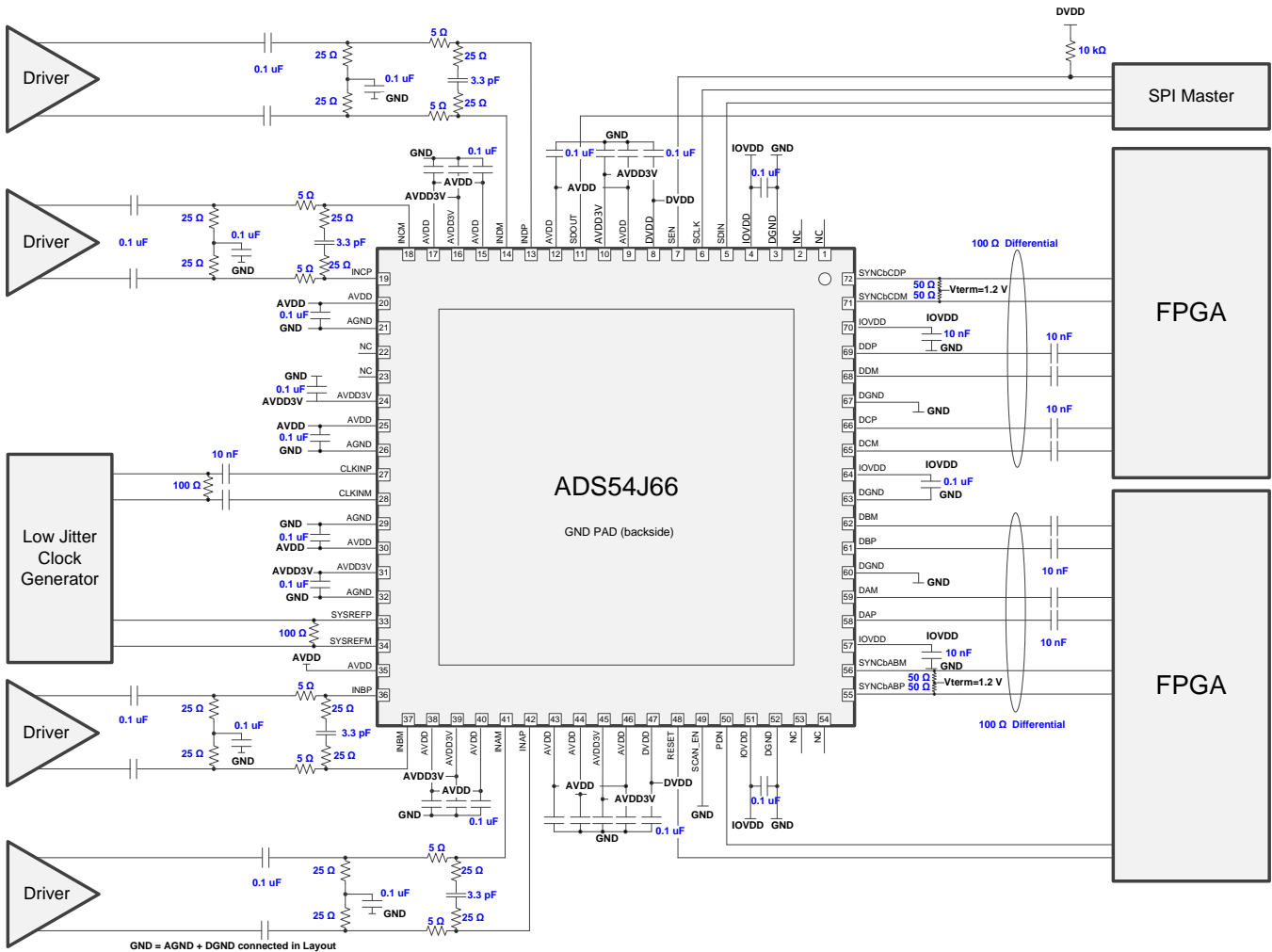

NOTE: GND = AGND and DGND are connected in the PCB layout.

Figure 144. Application Diagram for the ADS54J66

8.2.1 Design Requirements

By using the simple drive circuit of Figure 144 (when the amplifier drives the ADC) or Figure 51 (when transformers drive the ADC), uniform performance can be obtained over a wide frequency range. The buffers present at the analog inputs of the device help isolate the external drive source from the switching currents of the sampling circuit.

8.2.2 Detailed Design Procedure

For optimum performance, the analog inputs must be driven differentially. This architecture improves the common-mode noise immunity and even-order harmonic rejection. A small resistor (5Ω to 10Ω) in series with each input pin is recommended to damp out ringing caused by package parasitics, as shown in Figure 144.

Typical Application (continued)

8.2.3 Application Curves

Figure 145 and Figure 146 show the typical performance at 190 MHz and 230 MHz, respectively.

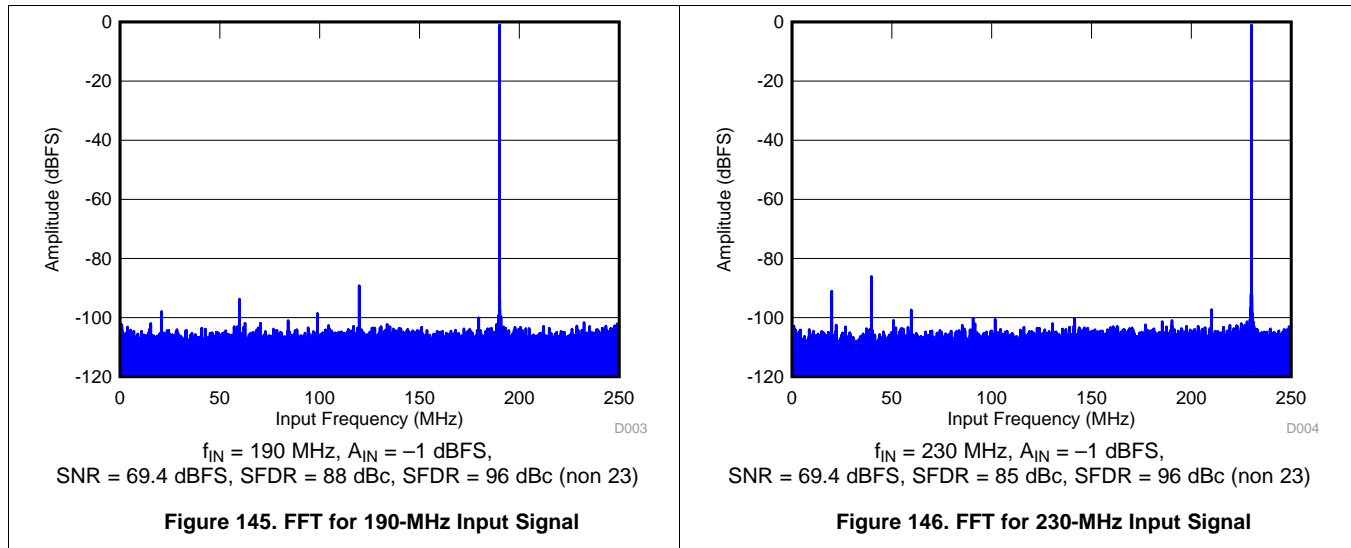

9 Power Supply Recommendations

The device requires a 1.9-V nominal supply for DVDD, a 1.9-V nominal supply for AVDD, and a 3-V nominal supply for AVDD3V. There is no specific sequence for power-supply requirements during device power-up. AVDD, DVDD, and AVDD3V can power-up in any order.

10 Layout

10.1 Layout Guidelines

The device evaluation module (EVM) layout can be used as a reference layout to obtain the best performance. A layout diagram of the EVM top layer is provided in [Figure 147](#). A complete layout of the EVM is available at the [ADS54J66 EVM folder](#). Some important points to remember during board layout are:

- Analog inputs are located on opposite sides of the device pinout to ensure minimum crosstalk on the package level. To minimize crosstalk onboard, the analog inputs must exit the pinout in opposite directions, as shown in the reference layout of [Figure 147](#) as much as possible.
- In the device pinout, the sampling clock is located on a side perpendicular to the analog inputs in order to minimize coupling between them. This configuration is also maintained on the reference layout of [Figure 147](#) as much as possible.
- Keep digital outputs away from the analog inputs. When these digital outputs exit the pinout, the digital output traces must not be kept parallel to the analog input traces because this configuration can result in coupling from the digital outputs to the analog inputs and degrade performance. All digital output traces to the receiver [such as a field-programmable gate array (FPGA) or an application-specific integrated circuit (ASIC)] must be matched in length to avoid skew among outputs.
- At each power-supply pin (AVDD, DVDD, or AVDDD3V), keep a 0.1- μ F decoupling capacitor close to the device. A separate decoupling capacitor group consisting of a parallel combination of 10- μ F, 1- μ F, and 0.1- μ F capacitors can be kept close to the supply source.

10.2 Layout Example

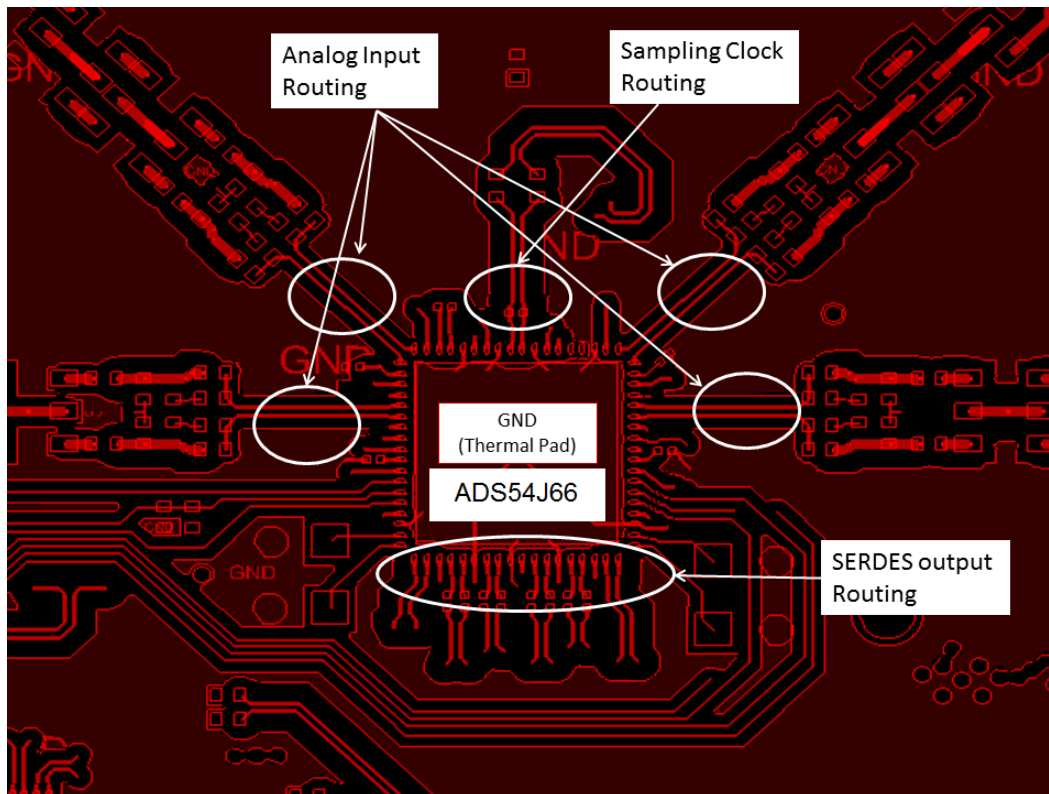

Figure 147. ADS54J66EVM Layout

11 Device and Documentation Support

11.1 Community Resources

The following links connect to TI community resources. Linked contents are provided "AS IS" by the respective contributors. They do not constitute TI specifications and do not necessarily reflect TI's views; see TI's [Terms of Use](#).

TI E2E™ Online Community *TI's Engineer-to-Engineer (E2E) Community*. Created to foster collaboration among engineers. At e2e.ti.com, you can ask questions, share knowledge, explore ideas and help solve problems with fellow engineers.

Design Support *TI's Design Support* Quickly find helpful E2E forums along with design support tools and contact information for technical support.

11.2 Trademarks

E2E is a trademark of Texas Instruments.
All other trademarks are the property of their respective owners.

11.3 Electrostatic Discharge Caution



These devices have limited built-in ESD protection. The leads should be shorted together or the device placed in conductive foam during storage or handling to prevent electrostatic damage to the MOS gates.

11.4 Glossary

[SLYZ022](#) — *TI Glossary*.

This glossary lists and explains terms, acronyms, and definitions.

12 Mechanical, Packaging, and Orderable Information

The following pages include mechanical, packaging, and orderable information. This information is the most current data available for the designated devices. This data is subject to change without notice and revision of this document. For browser-based versions of this data sheet, refer to the left-hand navigation.

PACKAGING INFORMATION

Orderable Device	Status (1)	Package Type	Package Drawing	Pins	Package Qty	Eco Plan (2)	Lead/Ball Finish (6)	MSL Peak Temp (3)	Op Temp (°C)	Device Marking (4/5)	Samples
ADS54J66IRMP	ACTIVE	VQFN	RMP	72	168	Green (RoHS & no Sb/Br)	NIPDAU	Level-3-260C-168 HR	-40 to 85	AZ54J66	Samples
ADS54J66IRMPT	ACTIVE	VQFN	RMP	72	250	Green (RoHS & no Sb/Br)	NIPDAU	Level-3-260C-168 HR	-40 to 85	AZ54J66	Samples

(1) The marketing status values are defined as follows:

ACTIVE: Product device recommended for new designs.

LIFEBUY: TI has announced that the device will be discontinued, and a lifetime-buy period is in effect.

NRND: Not recommended for new designs. Device is in production to support existing customers, but TI does not recommend using this part in a new design.

PREVIEW: Device has been announced but is not in production. Samples may or may not be available.

OBSOLETE: TI has discontinued the production of the device.

(2) **RoHS:** TI defines "RoHS" to mean semiconductor products that are compliant with the current EU RoHS requirements for all 10 RoHS substances, including the requirement that RoHS substance do not exceed 0.1% by weight in homogeneous materials. Where designed to be soldered at high temperatures, "RoHS" products are suitable for use in specified lead-free processes. TI may reference these types of products as "Pb-Free".

RoHS Exempt: TI defines "RoHS Exempt" to mean products that contain lead but are compliant with EU RoHS pursuant to a specific EU RoHS exemption.

Green: TI defines "Green" to mean the content of Chlorine (Cl) and Bromine (Br) based flame retardants meet JS709B low halogen requirements of <=1000ppm threshold. Antimony trioxide based flame retardants must also meet the <=1000ppm threshold requirement.

(3) MSL, Peak Temp. - The Moisture Sensitivity Level rating according to the JEDEC industry standard classifications, and peak solder temperature.

(4) There may be additional marking, which relates to the logo, the lot trace code information, or the environmental category on the device.

(5) Multiple Device Markings will be inside parentheses. Only one Device Marking contained in parentheses and separated by a "~" will appear on a device. If a line is indented then it is a continuation of the previous line and the two combined represent the entire Device Marking for that device.

(6) Lead/Ball Finish - Orderable Devices may have multiple material finish options. Finish options are separated by a vertical ruled line. Lead/Ball Finish values may wrap to two lines if the finish value exceeds the maximum column width.

Important Information and Disclaimer:The information provided on this page represents TI's knowledge and belief as of the date that it is provided. TI bases its knowledge and belief on information provided by third parties, and makes no representation or warranty as to the accuracy of such information. Efforts are underway to better integrate information from third parties. TI has taken and continues to take reasonable steps to provide representative and accurate information but may not have conducted destructive testing or chemical analysis on incoming materials and chemicals. TI and TI suppliers consider certain information to be proprietary, and thus CAS numbers and other limited information may not be available for release.

In no event shall TI's liability arising out of such information exceed the total purchase price of the TI part(s) at issue in this document sold by TI to Customer on an annual basis.

EXAMPLE BOARD LAYOUT

RMP0072A

VQFN - 0.9 mm max height

VQFN

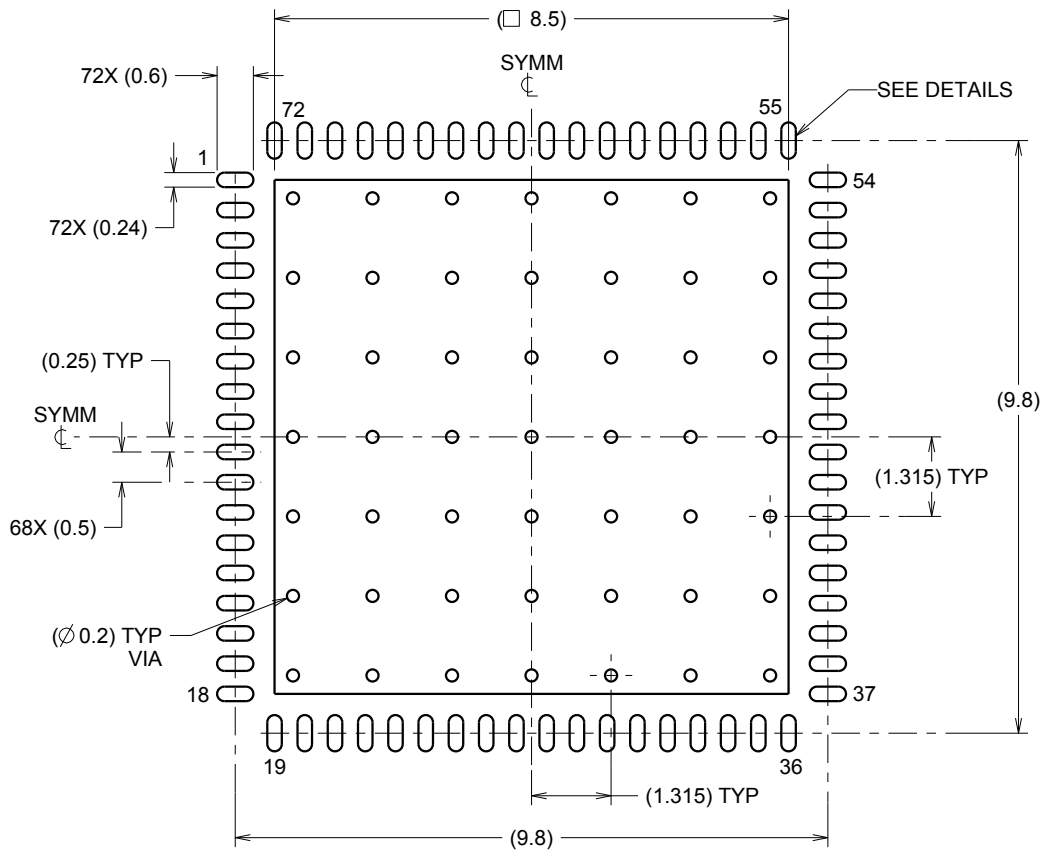

LAND PATTERN EXAMPLE
SCALE:8X

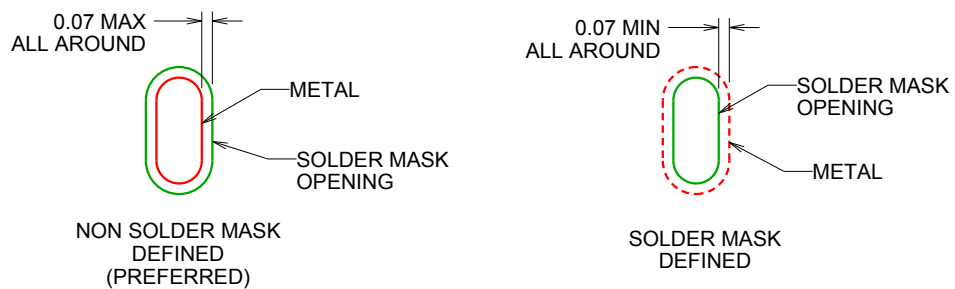

SOLDER MASK DETAILS

4221047/B 02/2014

NOTES: (continued)

- This package is designed to be soldered to a thermal pad on the board. For more information, see QFN/SON PCB application report in literature No. SLUA271 (www.ti.com/lit/slua271).

EXAMPLE STENCIL DESIGN

RMP0072A

VQFN - 0.9 mm max height

VQFN

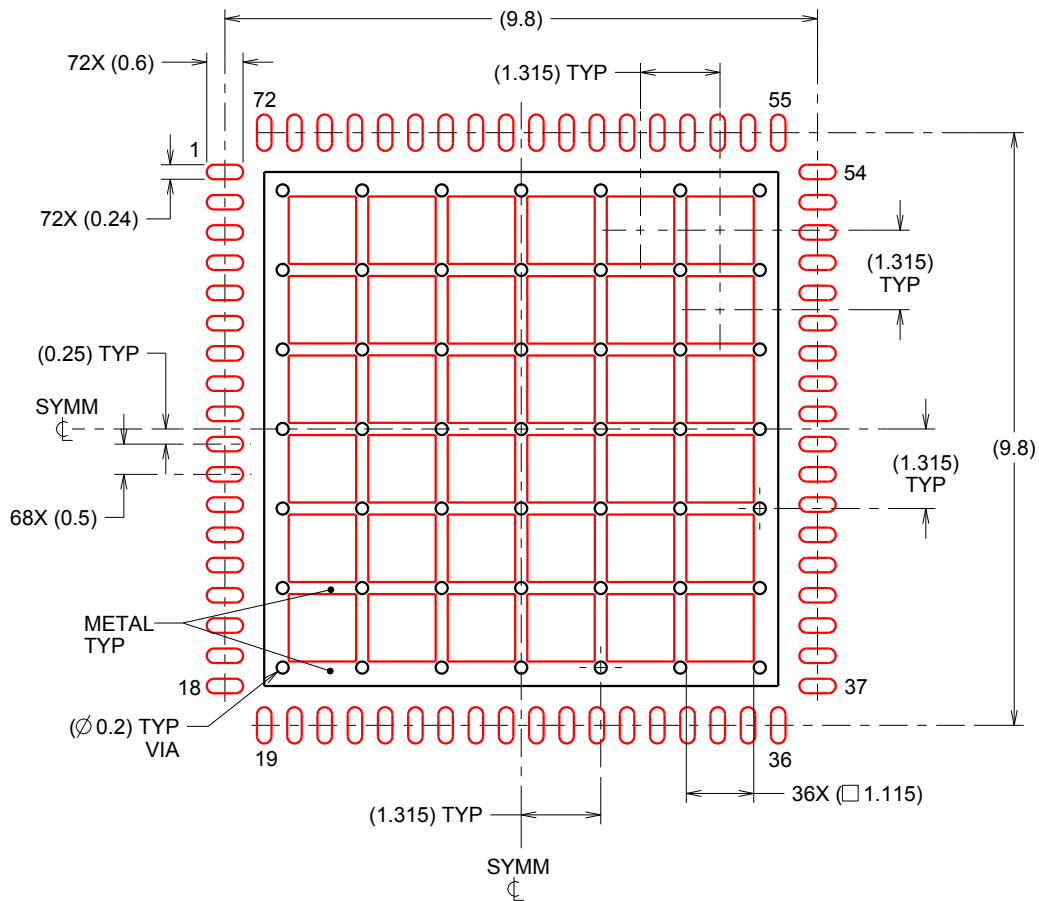

SOLDER PASTE EXAMPLE
 BASED ON 0.125 mm THICK STENCIL

EXPOSED PAD
 62% PRINTED SOLDER COVERAGE BY AREA
 SCALE:8X

4221047/B 02/2014

NOTES: (continued)

5. Laser cutting apertures with trapezoidal walls and rounded corners may offer better paste release. IPC-7525 may have alternate design recommendations.

IMPORTANT NOTICE AND DISCLAIMER

TI PROVIDES TECHNICAL AND RELIABILITY DATA (INCLUDING DATASHEETS), DESIGN RESOURCES (INCLUDING REFERENCE DESIGNS), APPLICATION OR OTHER DESIGN ADVICE, WEB TOOLS, SAFETY INFORMATION, AND OTHER RESOURCES "AS IS" AND WITH ALL FAULTS, AND DISCLAIMS ALL WARRANTIES, EXPRESS AND IMPLIED, INCLUDING WITHOUT LIMITATION ANY IMPLIED WARRANTIES OF MERCHANTABILITY, FITNESS FOR A PARTICULAR PURPOSE OR NON-INFRINGEMENT OF THIRD PARTY INTELLECTUAL PROPERTY RIGHTS.

These resources are intended for skilled developers designing with TI products. You are solely responsible for (1) selecting the appropriate TI products for your application, (2) designing, validating and testing your application, and (3) ensuring your application meets applicable standards, and any other safety, security, or other requirements. These resources are subject to change without notice. TI grants you permission to use these resources only for development of an application that uses the TI products described in the resource. Other reproduction and display of these resources is prohibited. No license is granted to any other TI intellectual property right or to any third party intellectual property right. TI disclaims responsibility for, and you will fully indemnify TI and its representatives against, any claims, damages, costs, losses, and liabilities arising out of your use of these resources.

TI's products are provided subject to TI's Terms of Sale (www.ti.com/legal/termsofsale.html) or other applicable terms available either on ti.com or provided in conjunction with such TI products. TI's provision of these resources does not expand or otherwise alter TI's applicable warranties or warranty disclaimers for TI products.

Mailing Address: Texas Instruments, Post Office Box 655303, Dallas, Texas 75265
Copyright © 2020, Texas Instruments Incorporated