

CDC2509C

3.3-V PHASE-LOCK LOOP CLOCK DRIVER

SCAS620A – DECEMBER 1998 – REVISED DECEMBER 2004

- Use **CDCVF2509A** as a Replacement for this Device
- Designed to Meet PC SDRAM Registered DIMM Design Support Document Rev. 1.2
- Spread Spectrum Clock Compatible
- Operating Frequency 25 MHz to 125 MHz
- Static tPhase Error Distribution at 66MHz to 100 MHz is ± 150 ps
- Drop-In Replacement for TI CDC2509A With Enhanced Performance
- Jitter (cyc – cyc) at 66 MHz to 100 MHz is |100 ps|
- Available in Plastic 24-Pin TSSOP
- Phase-Lock Loop Clock Distribution for Synchronous DRAM Applications
- Distributes One Clock Input to One Bank of Five and One Bank of Four Outputs
- Separate Output Enable for Each Output Bank
- External Feedback (FBIN) Terminal Is Used to Synchronize the Outputs to the Clock Input
- On-Chip Series Damping Resistors
- No External RC Network Required
- Operates at 3.3 V

**PW PACKAGE
(TOP VIEW)**



description

The CDC2509C is a high-performance, low-skew, low-jitter, phase-lock loop (PLL) clock driver. It uses a PLL to precisely align, in both frequency and phase, the feedback (FBOUT) output to the clock (CLK) input signal. It is specifically designed for use with synchronous DRAMs. The CDC2509C operates at 3.3 V V_{CC}. It also provides integrated series-damping resistors that make it ideal for driving point-to-point loads.

One bank of five outputs and one bank of four outputs provide nine low-skew, low-jitter copies of CLK. Output signal duty cycles are adjusted to 50%, independent of the duty cycle at CLK. Each bank of outputs is enabled or disabled separately via the control (1G and 2G) inputs. When the G inputs are high, the outputs switch in phase and frequency with CLK; when the G inputs are low, the outputs are disabled to the logic-low state.

Unlike many products containing PLLs, the CDC2509C does not require external RC networks. The loop filter for the PLL is included on-chip, minimizing component count, board space, and cost.

Because it is based on PLL circuitry, the CDC2509C requires a stabilization time to achieve phase lock of the feedback signal to the reference signal. This stabilization time is required, following power up and application of a fixed-frequency, fixed-phase signal at CLK, and following any changes to the PLL reference or feedback signals. The PLL can be bypassed for test purposes by strapping AV_{CC} to ground.

The CDC2509C is characterized for operation from 0°C to 85°C.



Please be aware that an important notice concerning availability, standard warranty, and use in critical applications of Texas Instruments semiconductor products and disclaimers thereto appears at the end of this data sheet.

PRODUCTION DATA information is current as of publication date. Products conform to specifications per the terms of Texas Instruments standard warranty. Production processing does not necessarily include testing of all parameters.



POST OFFICE BOX 655303 • DALLAS, TEXAS 75265

Copyright © 1998 – 2004, Texas Instruments Incorporated

CDC2509C

3.3-V PHASE-LOCK LOOP CLOCK DRIVER

SCAS620A – DECEMBER 1998 – REVISED DECEMBER 2004

description (continued)

For application information refer to application reports *High Speed Distribution Design Techniques for CDC509/516/2509/2510/2516* (literature number SLMA003) and *Using CDC2509A/2510A PLL with Spread Spectrum Clocking (SSC)* (literature number SCAA039).

FUNCTION TABLE

INPUTS			OUTPUTS		
1G	2G	CLK	1Y (0:4)	2Y (0:3)	FBOUT
X	X	L	L	L	L
L	L	H	L	L	H
L	H	H	L	H	H
H	L	H	H	L	H
H	H	H	H	H	H

functional block diagram

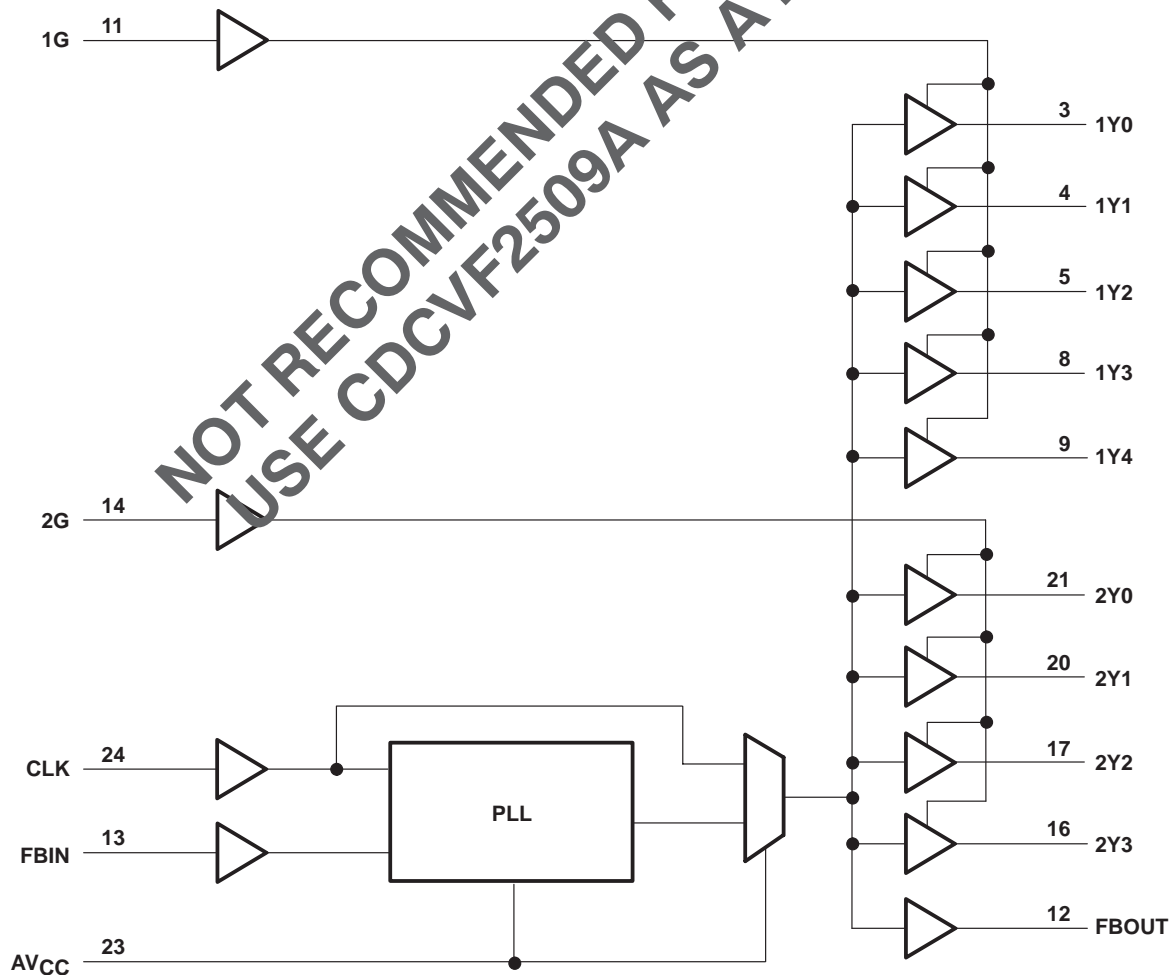

AVAILABLE OPTIONS



CDC2509C

3.3-V PHASE-LOCK LOOP CLOCK DRIVER

SCAS620A – DECEMBER 1998 – REVISED DECEMBER 2004

T_A	PACKAGE
	SMALL OUTLINE (PW)
0°C to 85°C	CDC2509CPWR

Terminal Functions

TERMINAL		TYPE	DESCRIPTION
NAME	NO.		
CLK	24	I	Clock input. CLK provides the clock signal to be distributed by the CDC2509C clock driver. CLK is used to provide the reference signal to the integrated PLL that generates the clock output signals. CLK must have a fixed frequency and fixed phase for the PLL to obtain phase lock. Once the circuit is powered up and a valid CLK signal is applied, a stabilization time is required for the PLL to phase lock the feedback signal to its reference signal.
FBIN	13	I	Feedback input. FBIN provides the feedback signal to the internal PLL. FBIN must be hard-wired to FBOUT to complete the PLL. The integrated PLL synchronizes CLK and FBIN so that there is nominally zero phase error between CLK and FBIN.
1G	11	I	Output bank enable. 1G is the output enable for outputs 1Y(0:4). When 1G is low, outputs 1Y(0:4) are disabled to a logic-low state. When 1G is high, all outputs 1Y(0:4) are enabled and switch at the same frequency as CLK.
2G	14	I	Output bank enable. 2G is the output enable for outputs 2Y(0:3). When 2G is low, outputs 2Y(0:3) are disabled to a logic-low state. When 2G is high, all outputs 2Y(0:3) are enabled and switch at the same frequency as CLK.
FBOUT	12	O	Feedback output. FBOUT is dedicated for external feedback. It switches at the same frequency as CLK. When externally wired to FBIN, FBOUT completes the feedback loop of the PLL. FBOUT has an integrated 25- Ω series-damping resistor.
1Y (0:4)	3, 4, 5, 8, 9	O	Clock outputs. These outputs provide low-skew copies of CLK. Output bank 1Y(0:4) is enabled via the 1G input. These outputs can be disabled to a logic-low state by deasserting the 1G control input. Each output has an integrated 25- Ω series-damping resistor.
2Y (0:3)	21, 20, 17, 16	O	Clock outputs. These outputs provide low-skew copies of CLK. Output bank 2Y(0:3) is enabled via the 2G input. These outputs can be disabled to a logic-low state by deasserting the 2G control input. Each output has an integrated 25- Ω series-damping resistor.
AV _{CC}	23	Power	Analog power supply. AV _{CC} provides the power reference for the analog circuitry. In addition, AV _{CC} can be used to bypass the PLL for test purposes. When AV _{CC} is strapped to ground, PLL is bypassed and CLK is buffered directly to the device outputs.
AGND	1	Ground	Analog ground. AGND provides the ground reference for the analog circuitry.
V _{CC}	2, 10, 15, 22	Power	Power supply
GND	6, 7, 18, 19	Ground	Ground



CDC2509C

3.3-V PHASE-LOCK LOOP CLOCK DRIVER

SCAS620A – DECEMBER 1998 – REVISED DECEMBER 2004

absolute maximum ratings over operating free-air temperature range (unless otherwise noted)†

Supply voltage range, AV_{CC} (see Note 1)	$AV_{CC} < V_{CC} + 0.7$ V
Supply voltage range, V_{CC}	-0.5 V to 4.6 V
Input voltage range, V_I (see Note 2)	-0.5 V to 6.5 V
Voltage range applied to any output in the high or low state, V_O (see Notes 2 and 3)	-0.5 V to $V_{CC} + 0.5$ V
Input clamp current, I_{IK} ($V_I < 0$)	-50 mA
Output clamp current, I_{OK} ($V_O < 0$ or $V_O > V_{CC}$)	±50 mA
Continuous output current, I_O ($V_O = 0$ to V_{CC})	±50 mA
Continuous current through each V_{CC} or GND	±100 mA
Maximum power dissipation at $T_A = 55^\circ\text{C}$ (in still air) (see Note 4)	0.7 W
Storage temperature range, T_{stg}	-65°C to 150°C

† Stresses beyond those listed under “absolute maximum ratings” may cause permanent damage to the device. These are stress ratings only, and functional operation of the device at these or any other conditions beyond those indicated under “recommended operating conditions” is not implied. Exposure to absolute-maximum-rated conditions for extended periods may affect device reliability.

NOTES: 1. AV_{CC} **must not** exceed V_{CC} .

2. The input and output negative-voltage ratings may be exceeded if the input and output clamp-current ratings are observed.

3. This value is limited to 4.6 V maximum.

4. The maximum package power dissipation is calculated using a junction temperature of 150°C and a board trace length of 750 mils. For more information, refer to the *Package Thermal Considerations* application note in the *ABT Advanced BiCMOS Technology Data Book*, literature number SCBD002.

recommended operating conditions (see Note 5)

	MIN	MAX	UNIT
V_{CC}, AV_{CC} Supply voltage	3	3.6	V
V_{IH} High-level input voltage	2		V
V_{IL} Low-level input voltage		0.8	V
V_I Input voltage	0	V_{CC}	V
I_{OH} High-level output current		-12	mA
I_{OL} Low-level output current		12	mA
T_A Operating free-air temperature	0	85	°C

NOTE 5: Unused inputs must be held high or low to prevent them from floating.

timing requirements over recommended ranges of supply voltage and operating free-air temperature

	MIN	MAX	UNIT
f_{clk} Clock frequency	25	125	MHz
Input clock duty cycle	40%	60%	
Stabilization time†		1	ms

† Time required for the integrated PLL circuit to obtain phase lock of its feedback signal to its reference signal. For phase lock to be obtained, a fixed-frequency, fixed-phase reference signal must be present at CLK. Until phase lock is obtained, the specifications for propagation delay, skew, and jitter parameters given in the switching characteristics table are not applicable. This parameter does not apply for input modulation under SSC application.



CDC2509C

3.3-V PHASE-LOCK LOOP CLOCK DRIVER

SCAS620A – DECEMBER 1998 – REVISED DECEMBER 2004

electrical characteristics over recommended operating free-air temperature range (unless otherwise noted)

PARAMETER		TEST CONDITIONS	V _{CC} , AV _{CC}	MIN	TYP [‡]	MAX	UNIT
V _{IK}	Input clamp voltage	I _I = -18 mA	3 V			-1.2	V
V _{OH}	High-level output voltage	I _{OH} = -100 μA	MIN to MAX	V _{CC} -0.2			V
		I _{OH} = -12 mA	3 V		2.1		
		I _{OH} = -6 mA	3 V		2.4		
V _{OL}	Low-level output voltage	I _{OL} = 100 μA	MIN to MAX			0.2	V
		I _{OL} = 12 mA	3 V			0.8	
		I _{OL} = 6 mA	3 V			0.55	
I _{OH}	High-level output current	V _O = 1 V	3.135 V			-32	mA
		V _O = 1.65 V	3.3 V			-36	
		V _O = 3.135 V	3.465 V			-12	
I _{OL}	Low-level output current	V _O = 1.95 V	3.135 V	34			mA
		V _O = 1.65 V	3.3 V		40		
		V _O = 0.4 V	3.465 V			14	
I _I	Input current	V _I = V _{CC} or GND	3.6 V			±5	μA
I _{CC} [§]	Supply current	V _I = V _{CC} or GND, V _O = 0, Outputs: low or high	3.6 V			10	μA
ΔI _{CC}	Change in supply current	One input at V _{CC} - 0.6 V, Other inputs = V _{CC} or GND	3.3 V to 3.6 V			500	μA
C _i	Input capacitance	V _I = V _{CC} or GND	3.3 V			4	pF
C _o	Output capacitance	V _O = V _{CC} or GND	3.3 V			6	pF

[‡] For conditions shown as MIN or MAX, use the appropriate value specified under recommended operating conditions.

[§] For I_{CC} of AV_{CC}, and I_{CC} vs Frequency (see Figures 11 and 12).

switching characteristics over recommended ranges of supply voltage and operating free-air temperature, C_L = 30 pF (see Note 6 and Figures 1 and 2)[‡]

PARAMETER	FROM (INPUT)/CONDITION	TO (OUTPUT)	V _{CC} , AV _{CC} = 3.3 V ± 0.165 V			UNIT
			MIN	TYP	MAX	
Phase error time – static (normalized) (See Figures 3 – 5)	CLKIN↑ = 66 MHz to 100 MHz	FBIN↑	-150		150	ps
t _{sk(o)} Output skew time [§]	Any Y or FBOUT	Any Y or FBOUT			200	ps
Phase error time – jitter (see Note 7)	Clkin = 66 MHz to 100 MHz	Any Y or FBOUT	-50		50	ps
Jitter _(cycle-cycle) (See Figures 9 and 10)		Any Y or FBOUT			100	
Duty cycle	F(clkin > 60 MHz)	Any Y or FBOUT	45%		55%	
t _r Rise time (See Notes 8 and 9)	V _O = 1.2 V to 1.8 V, IBIS simulation	Any Y or FBOUT	2.5		1	V/ns
t _f Fall time (See Notes 8 and 9)	V _O = 1.2 V to 1.8 V, IBIS simulation	Any Y or FBOUT	2.5		1	V/ns

[‡] These parameters are not production tested.

[§] The t_{sk(o)} specification is only valid for equal loading of all outputs.

NOTES: 6. The specifications for parameters in this table are applicable only after any appropriate stabilization time has elapsed.

7. Calculated per PC DRAM SPEC (t_{phase error, static – jitter_(cycle-to-cycle)}).

8. This is equivalent to 0.8 ns/2.5 ns and 0.8 ns/2.7 ns into standard 500 Ω/ 30 pF load for output swing of 0.4 V to 2 V.

9. 64 MB DIMM configuration according to PC SDRAM Registered DIMM Design Support Document, Figure 20 and Table 13.

Intel is a trademark of Intel Corporation.

PC SDRAM Register DIMM Design Support Document is published by Intel Corporation.



CDC2509C
3.3-V PHASE-LOCK LOOP CLOCK DRIVER

SCAS620A – DECEMBER 1998 – REVISED DECEMBER 2004

PARAMETER MEASUREMENT INFORMATION

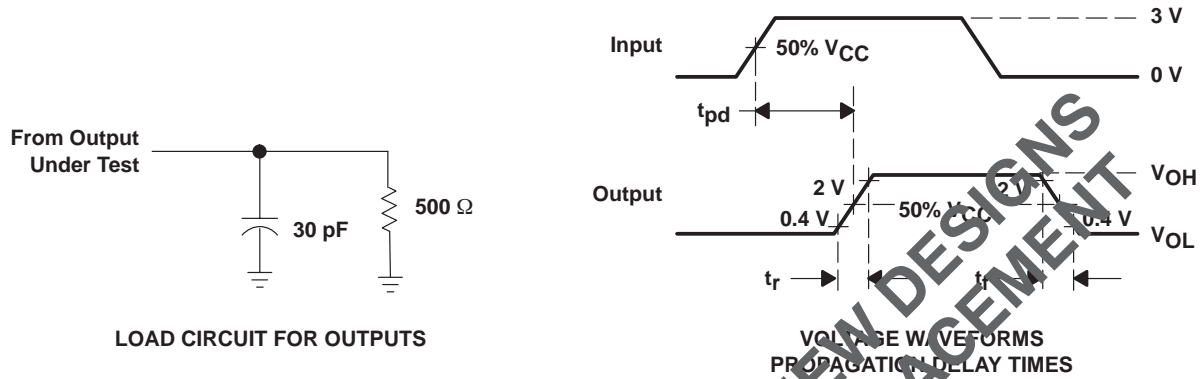

- NOTES: A. C_L includes probe and jig capacitance.
 B. All input pulses are supplied by generators having the following characteristics: PRR ≤ 100 MHz, Z_O = 50 Ω, t_r ≤ 1.2 ns, t_f ≤ 1.2 ns.
 C. The outputs are measured one at a time with one transition per measurement.

Figure 1. Load Circuit and Voltage Waveforms

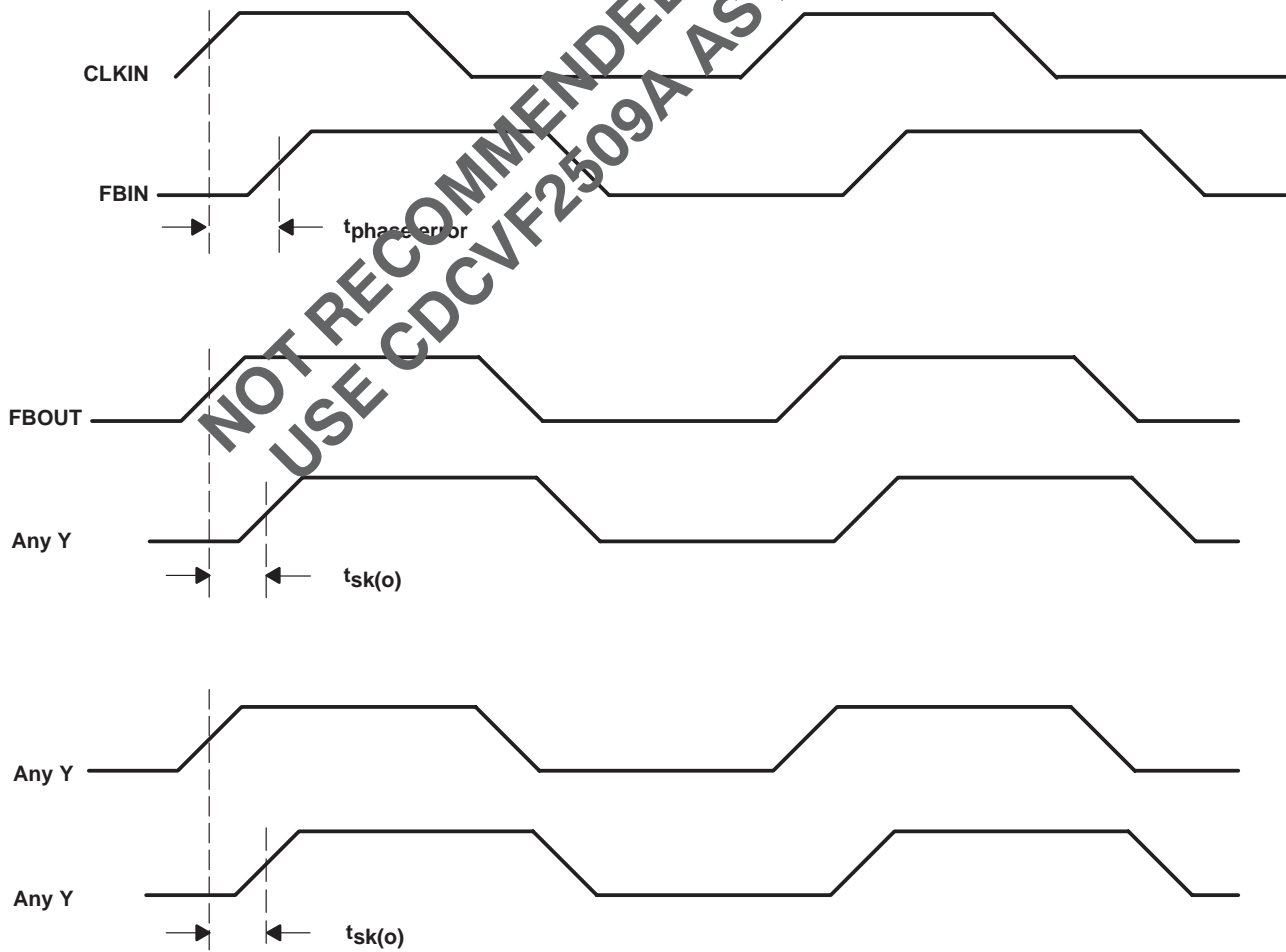

Figure 2. Phase Error and Skew Calculations

TYPICAL CHARACTERISTICS

CDC2509C
PHASE ADJUSTMENT SLOPE AND PHASE ERROR
vs
LOAD CAPACITANCE

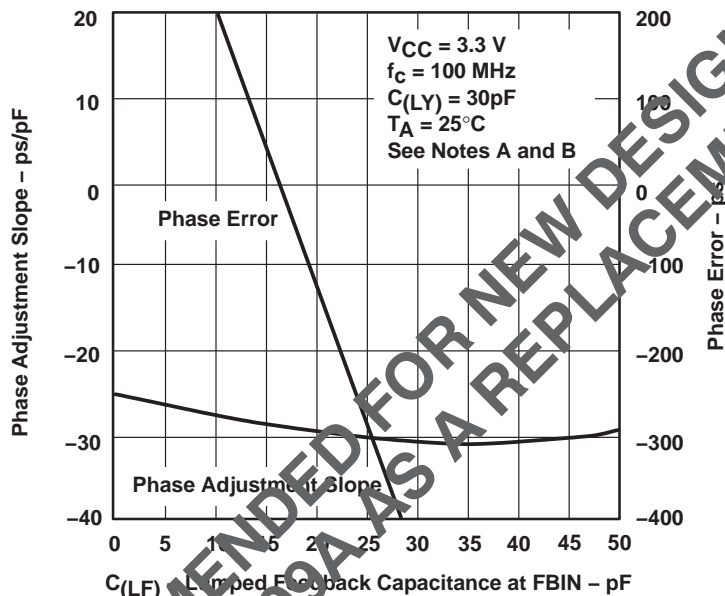

Figure 3
CDC2509A
PHASE ADJUSTMENT SLOPE AND PHASE ERROR
vs
LOAD CAPACITANCE

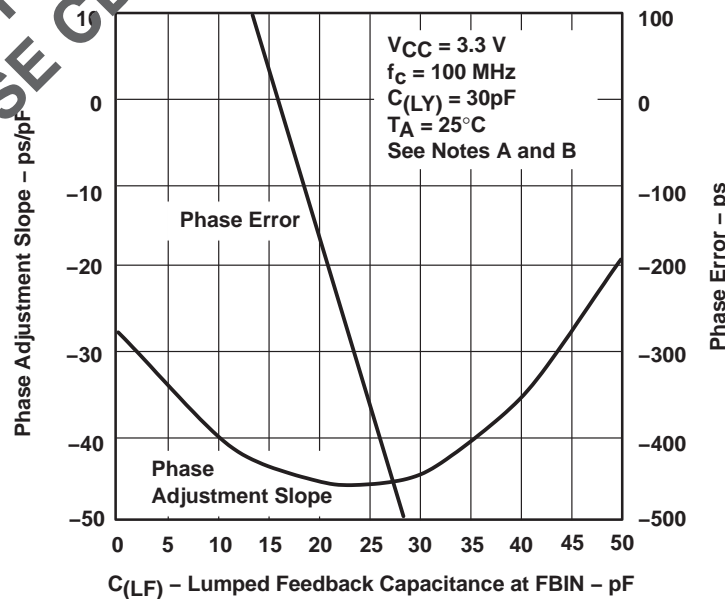

Figure 4

NOTES: A. Trace feedback length FBOUT to FBIN = 5 mm, $Z_0 = 50\ \Omega$ Phase error measured from CLK to Y
 B. CLF = Lumped feedback capacitance at FBIN

CDC2509C

3.3-V PHASE-LOCK LOOP CLOCK DRIVER

SCAS620A – DECEMBER 1998 – REVISED DECEMBER 2004

TYPICAL CHARACTERISTICS

**PHASE ERROR
vs
CLOCK FREQUENCY**

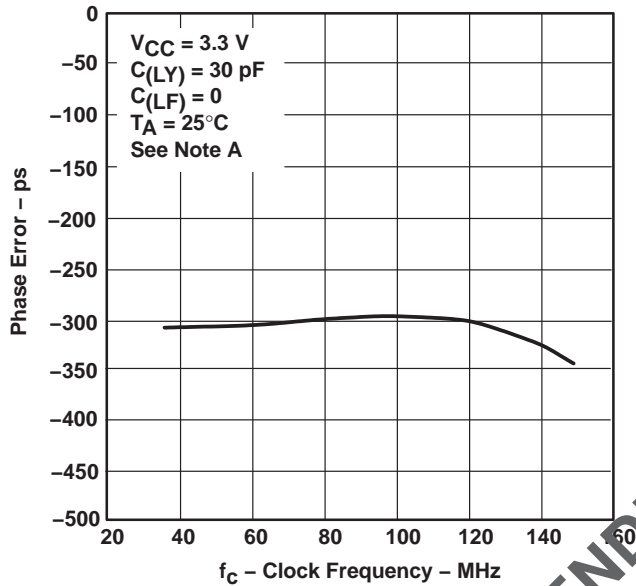

Figure 5

**PHASE ERROR
vs
SUPPLY VOLTAGE**

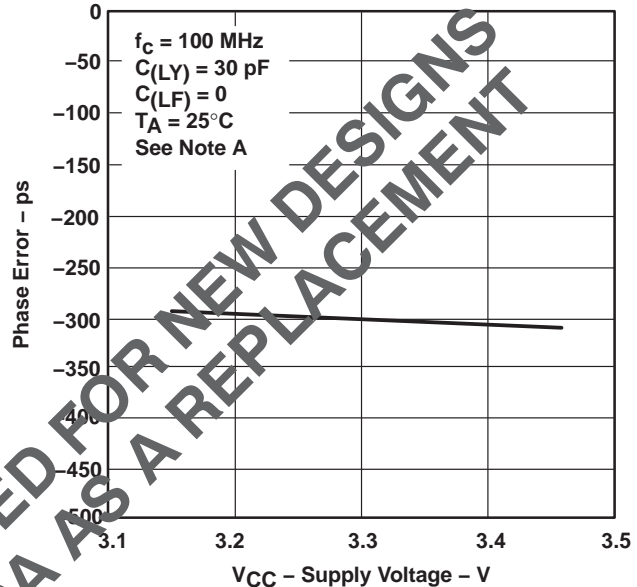

Figure 6

**CDC2509C
STATIC PHASE ERROR
vs
CLOCK FREQUENCY**

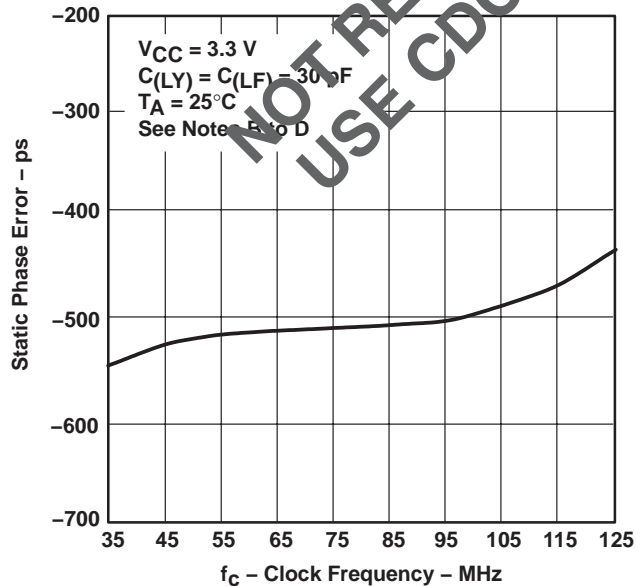

Figure 7

**CDC2509A
STATIC PHASE ERROR
vs
CLOCK FREQUENCY**

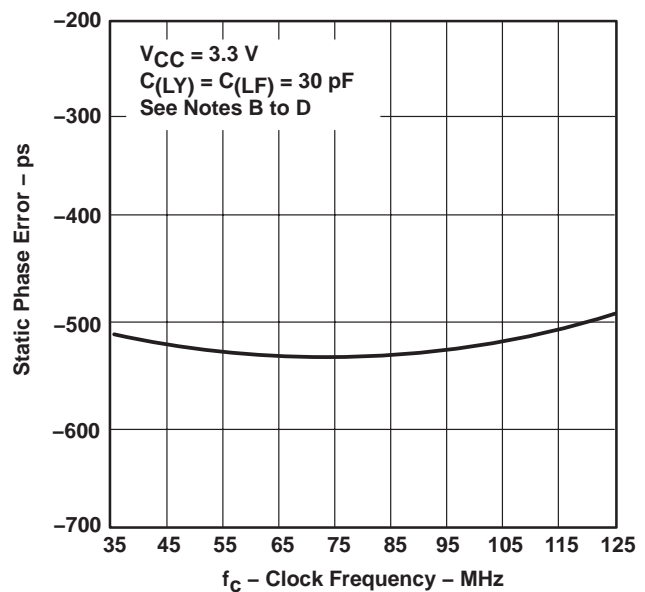
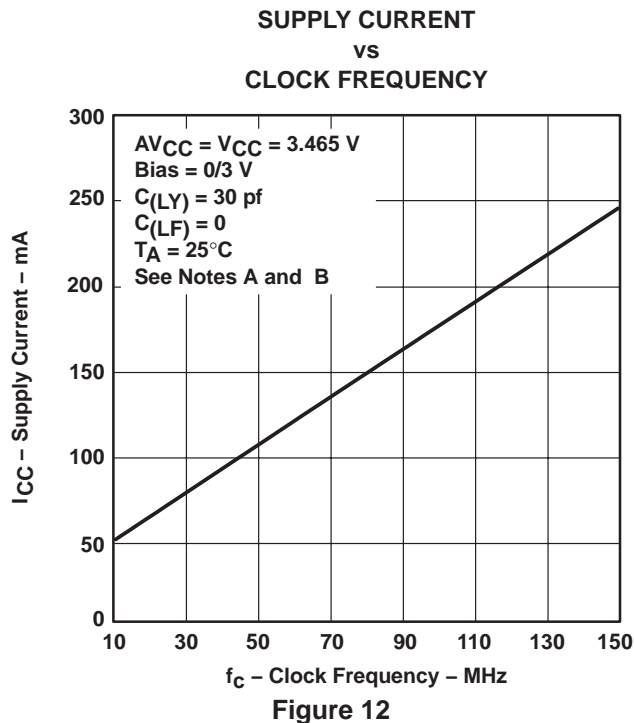
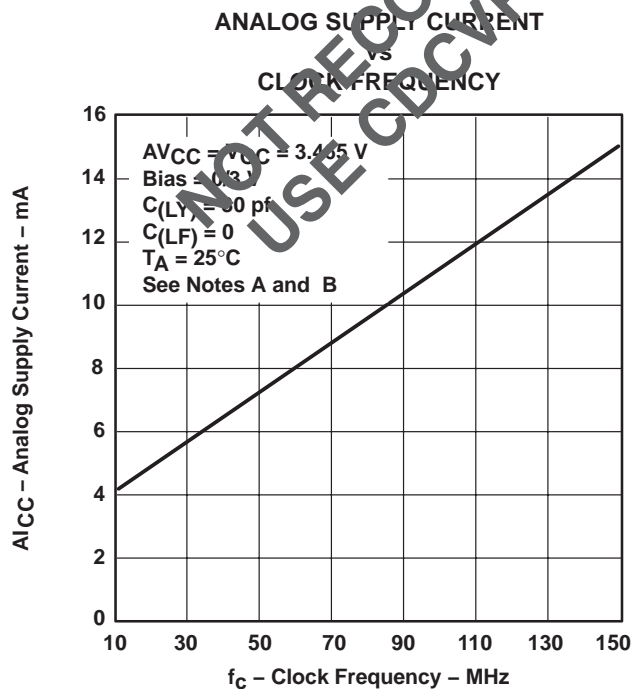
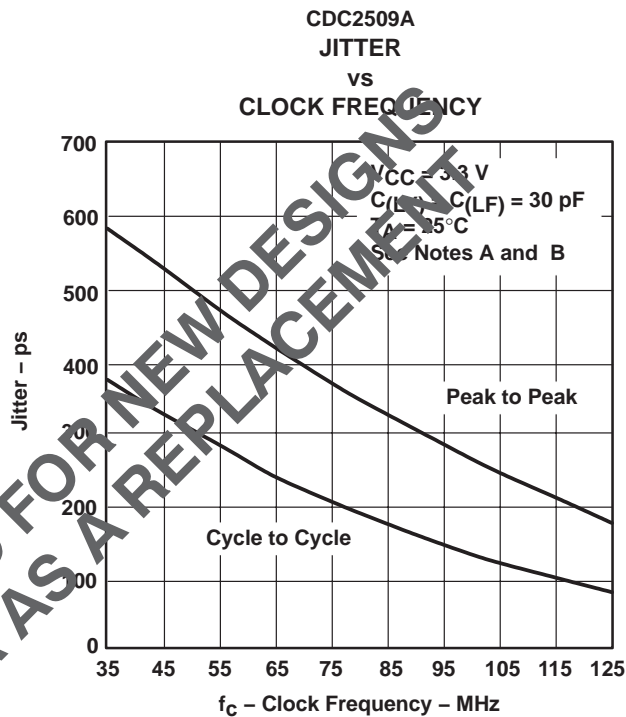
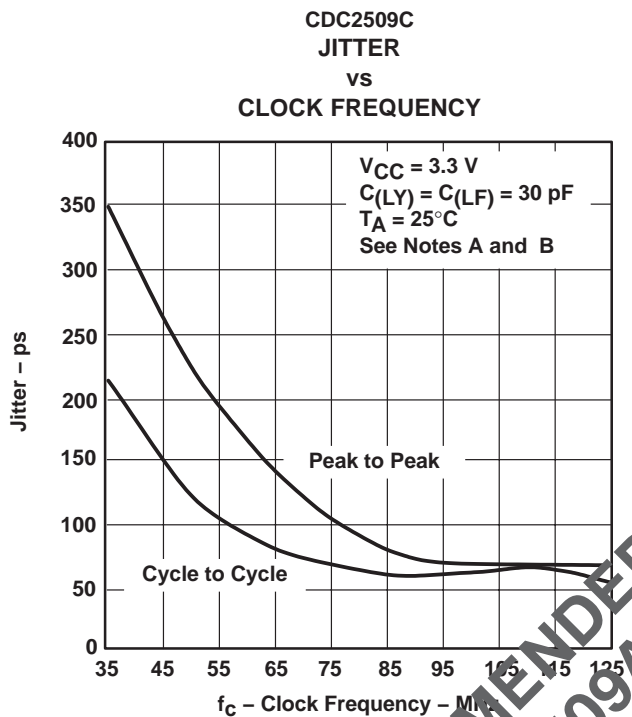

Figure 8

- NOTES: A. Trace feedback length FBOUT to FBIN = 5 mm, $Z_0 = 50\ \Omega$
 B. Phase error measured from CLK to FBIN
 C. CLY = Lumped capacitive load at Y
 D. CLF = Lumped feedback capacitance at FBIN

TYPICAL CHARACTERISTICS



NOTES: A. $C_{(LY)}$ = Lumped capacitive load at Y
B. $C_{(LF)}$ = Lumped feedback capacitance at FBIN

CDC2509C
3.3-V PHASE-LOCK LOOP CLOCK DRIVER

SCAS620A – DECEMBER 1998 – REVISED DECEMBER 2004

TYPICAL CHARACTERISTICS

**TI SILICON-BASED
 PLL PULLDOWN IBIS I/V**

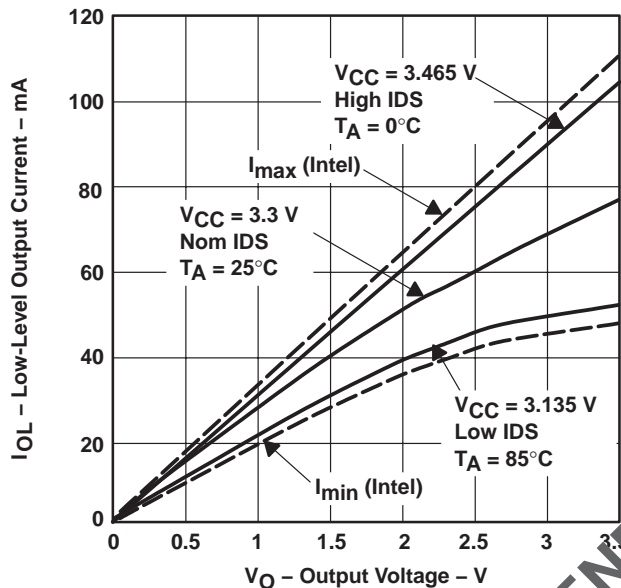

Figure 13

**TI SILICON-BASED
 PLL PULLUP IBIS I/V**

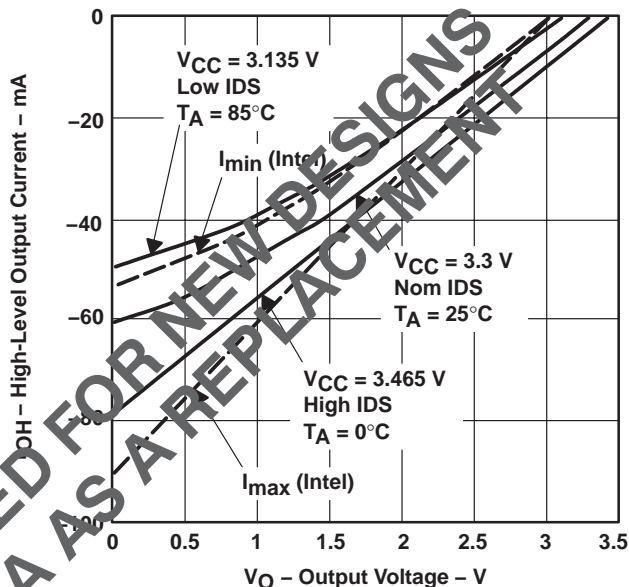

Figure 14

NOT RECOMMENDED FOR NEW DESIGNS
 USE CDCVF2509A AS A REPLACEMENT



PACKAGING INFORMATION

Orderable Device	Status (1)	Package Type	Package Drawing	Pins	Package Qty	Eco Plan (2)	Lead/Ball Finish (6)	MSL Peak Temp (3)	Op Temp (°C)	Device Marking (4/5)	Samples
CDC2509CPW	NRND	TSSOP	PW	24	60	Green (RoHS & no Sb/Br)	NIPDAU	Level-1-260C-UNLIM		CK2509C	
CDC2509CPWG4	NRND	TSSOP	PW	24	60	Green (RoHS & no Sb/Br)	NIPDAU	Level-1-260C-UNLIM		CK2509C	
CDC2509CPWR	NRND	TSSOP	PW	24	2000	Green (RoHS & no Sb/Br)	NIPDAU	Level-1-260C-UNLIM		CK2509C	
CDC2509CPWRG4	NRND	TSSOP	PW	24	2000	Green (RoHS & no Sb/Br)	NIPDAU	Level-1-260C-UNLIM		CK2509C	

(1) The marketing status values are defined as follows:

ACTIVE: Product device recommended for new designs.

LIFEBUY: TI has announced that the device will be discontinued, and a lifetime-buy period is in effect.

NRND: Not recommended for new designs. Device is in production to support existing customers, but TI does not recommend using this part in a new design.

PREVIEW: Device has been announced but is not in production. Samples may or may not be available.

OBSOLETE: TI has discontinued the production of the device.

(2) **RoHS:** TI defines "RoHS" to mean semiconductor products that are compliant with the current EU RoHS requirements for all 10 RoHS substances, including the requirement that RoHS substance do not exceed 0.1% by weight in homogeneous materials. Where designed to be soldered at high temperatures, "RoHS" products are suitable for use in specified lead-free processes. TI may reference these types of products as "Pb-Free".

RoHS Exempt: TI defines "RoHS Exempt" to mean products that contain lead but are compliant with EU RoHS pursuant to a specific EU RoHS exemption.

Green: TI defines "Green" to mean the content of Chlorine (Cl) and Bromine (Br) based flame retardants meet JS709B low halogen requirements of ≤ 1000 ppm threshold. Antimony trioxide based flame retardants must also meet the ≤ 1000 ppm threshold requirement.

(3) MSL, Peak Temp. - The Moisture Sensitivity Level rating according to the JEDEC industry standard classifications, and peak solder temperature.

(4) There may be additional marking, which relates to the logo, the lot trace code information, or the environmental category on the device.

(5) Multiple Device Markings will be inside parentheses. Only one Device Marking contained in parentheses and separated by a "-" will appear on a device. If a line is indented then it is a continuation of the previous line and the two combined represent the entire Device Marking for that device.

(6) Lead/Ball Finish - Orderable Devices may have multiple material finish options. Finish options are separated by a vertical ruled line. Lead/Ball Finish values may wrap to two lines if the finish value exceeds the maximum column width.

Important Information and Disclaimer: The information provided on this page represents TI's knowledge and belief as of the date that it is provided. TI bases its knowledge and belief on information provided by third parties, and makes no representation or warranty as to the accuracy of such information. Efforts are underway to better integrate information from third parties. TI has taken and

continues to take reasonable steps to provide representative and accurate information but may not have conducted destructive testing or chemical analysis on incoming materials and chemicals. TI and TI suppliers consider certain information to be proprietary, and thus CAS numbers and other limited information may not be available for release.

In no event shall TI's liability arising out of such information exceed the total purchase price of the TI part(s) at issue in this document sold by TI to Customer on an annual basis.

TAPE AND REEL INFORMATION



QUADRANT ASSIGNMENTS FOR PIN 1 ORIENTATION IN TAPE



*All dimensions are nominal

Device	Package Type	Package Drawing	Pins	SPQ	Reel Diameter (mm)	Reel Width W1 (mm)	A0 (mm)	B0 (mm)	K0 (mm)	P1 (mm)	W (mm)	Pin1 Quadrant
CDC2509CPWR	TSSOP	PW	24	2000	330.0	16.4	6.95	8.3	1.6	8.0	16.0	Q1

TAPE AND REEL BOX DIMENSIONS

*All dimensions are nominal

Device	Package Type	Package Drawing	Pins	SPQ	Length (mm)	Width (mm)	Height (mm)
CDC2509CPWR	TSSOP	PW	24	2000	367.0	367.0	38.0

PW0024A



PACKAGE OUTLINE
TSSOP - 1.2 mm max height

SMALL OUTLINE PACKAGE



4220208/A 02/2017

NOTES:

1. All linear dimensions are in millimeters. Any dimensions in parenthesis are for reference only. Dimensioning and tolerancing per ASME Y14.5M.
2. This drawing is subject to change without notice.
3. This dimension does not include mold flash, protrusions, or gate burrs. Mold flash, protrusions, or gate burrs shall not exceed 0.15 mm per side.
4. This dimension does not include interlead flash. Interlead flash shall not exceed 0.25 mm per side.
5. Reference JEDEC registration MO-153.

EXAMPLE BOARD LAYOUT

PW0024A

TSSOP - 1.2 mm max height

SMALL OUTLINE PACKAGE

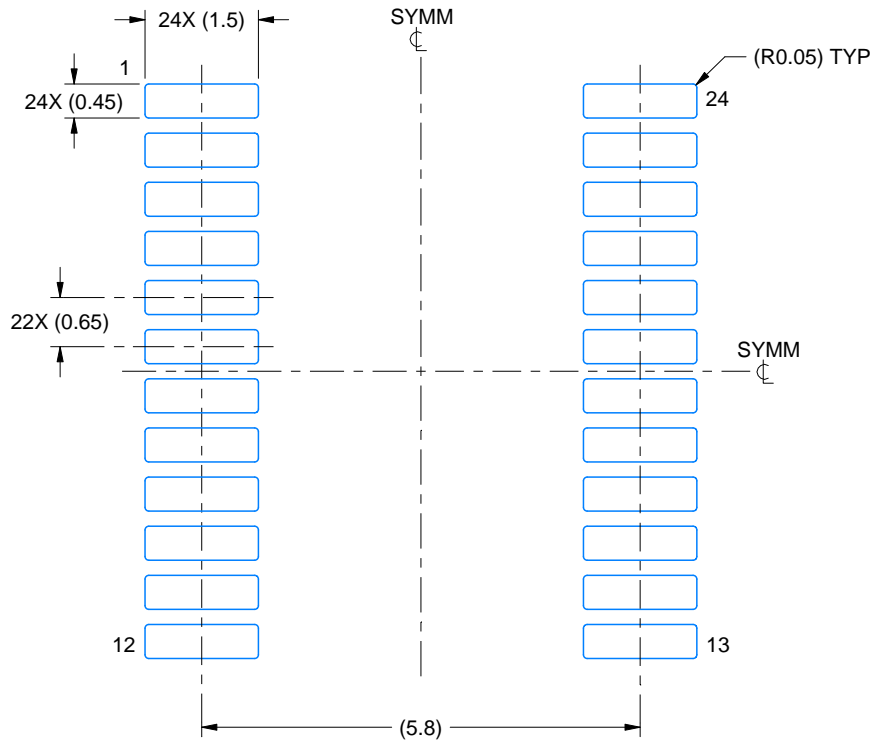

LAND PATTERN EXAMPLE
EXPOSED METAL SHOWN
SCALE: 10X



SOLDER MASK DETAILS

4220208/A 02/2017

NOTES: (continued)

6. Publication IPC-7351 may have alternate designs.
7. Solder mask tolerances between and around signal pads can vary based on board fabrication site.

EXAMPLE STENCIL DESIGN

PW0024A

TSSOP - 1.2 mm max height

SMALL OUTLINE PACKAGE



NOTES: (continued)

8. Laser cutting apertures with trapezoidal walls and rounded corners may offer better paste release. IPC-7525 may have alternate design recommendations.
9. Board assembly site may have different recommendations for stencil design.

IMPORTANT NOTICE AND DISCLAIMER

TI PROVIDES TECHNICAL AND RELIABILITY DATA (INCLUDING DATASHEETS), DESIGN RESOURCES (INCLUDING REFERENCE DESIGNS), APPLICATION OR OTHER DESIGN ADVICE, WEB TOOLS, SAFETY INFORMATION, AND OTHER RESOURCES "AS IS" AND WITH ALL FAULTS, AND DISCLAIMS ALL WARRANTIES, EXPRESS AND IMPLIED, INCLUDING WITHOUT LIMITATION ANY IMPLIED WARRANTIES OF MERCHANTABILITY, FITNESS FOR A PARTICULAR PURPOSE OR NON-INFRINGEMENT OF THIRD PARTY INTELLECTUAL PROPERTY RIGHTS.

These resources are intended for skilled developers designing with TI products. You are solely responsible for (1) selecting the appropriate TI products for your application, (2) designing, validating and testing your application, and (3) ensuring your application meets applicable standards, and any other safety, security, or other requirements. These resources are subject to change without notice. TI grants you permission to use these resources only for development of an application that uses the TI products described in the resource. Other reproduction and display of these resources is prohibited. No license is granted to any other TI intellectual property right or to any third party intellectual property right. TI disclaims responsibility for, and you will fully indemnify TI and its representatives against, any claims, damages, costs, losses, and liabilities arising out of your use of these resources.

TI's products are provided subject to TI's Terms of Sale (www.ti.com/legal/termsofsale.html) or other applicable terms available either on ti.com or provided in conjunction with such TI products. TI's provision of these resources does not expand or otherwise alter TI's applicable warranties or warranty disclaimers for TI products.

Mailing Address: Texas Instruments, Post Office Box 655303, Dallas, Texas 75265
Copyright © 2020, Texas Instruments Incorporated