

SSC Clock Generator/Buffer

FEATURES

- Part of a Family of Easy to use Clock Generator Devices With Optional SSC
- SSC Capable Clock Generator / Buffer
- SSC Controllable via 3 External Pins
 - $\pm 0\%$ to $\pm 1.5\%$ Center Spread
- 1 External Control Pin for SSC ON / OFF Selection
- 40 MHz to 108 MHz Single-Ended LVCMOS Input
- Single 3.3V Device Power Supply
- Wide Temperature Range – 40°C to 85°C
- Low Space Consumption by 8 Pin TSSOP Package

APPLICATIONS

- Consumer and Industrial Applications Requiring EMI Reduction through Spread Spectrum Clocking

PACKAGE

IN	1	8	VDD
SSC_SEL 0	2	7	SSC_SEL 2
SSC_SEL 1	3	6	OUT
GND	4	5	SSC_ON

BLOCK DIAGRAM

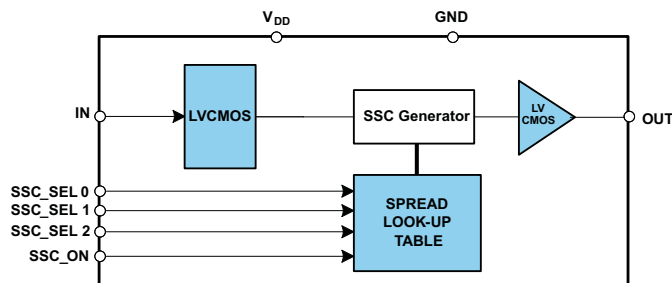

DESCRIPTION

The CDCS501 is a spread spectrum capable, LVCMOS Input Clock Buffer for EMI reduction.

The device is designed to counter common EMI problems in modern electronic designs.

It accepts a 3.3V LVCMOS signal at the input and spread this signal by a small amount, centered around the input frequency. The amount of spread can be selected via 3 control pins. The Functional Table contains detailed information on the amount of spread. A 4th control pin can be used to activate or deactivate the Spread Spectrum Clock Generator.

Selecting SSC_ON = off will turn the Spread Spectrum Clock Generator off only. The device will still pass the LVCMOS signal that's presented at its input through to its output. This pin is low active.

The wide operating frequency range covers most commonly used midrange Audio and Video frequencies. The CDCS501 operates in 3.3V environment.

It is characterized for operation from –40°C to 85°C, and available in an 8-pin TSSOP package.



Please be aware that an important notice concerning availability, standard warranty, and use in critical applications of Texas Instruments semiconductor products and disclaimers thereto appears at the end of this data sheet.



These devices have limited built-in ESD protection. The leads should be shorted together or the device placed in conductive foam during storage or handling to prevent electrostatic damage to the MOS gates.

FUNCTION TABLE

SSC_ON	SSC_SEL 0	SSC_SEL 1	SSC_SEL 2	SPREAD AMOUNT
1	x	x	X	0.00%
0	0	0	0	1.00%
0	0	0	1	1.50%
0	0	1	0	1.00%
0	0	1	1	1.50%
0	1	0	0	0.50%
0	1	0	1	0.75%
0	1	1	0	0.00%
0	1	1	1	0.50%

DEVICE INFORMATION

PACKAGE

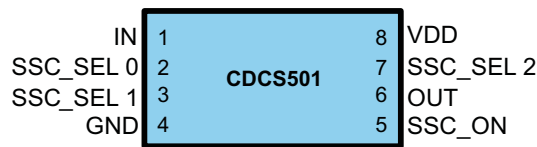

PIN FUNCTIONS

PIN			
NAME	NO.	Type	Description
IN	1	I	LVC MOS Clock Input
OUT	6	O	LVC MOS Clock Output
SSC_SEL 0, 1, 2	2, 3, 7	I	Spread Selection Pins, internal Pull-up
SSC_ON	5	I	SSC on/off Pin, active low; internal Pull-down
VDD	8	Power	3.3V Power Supply
GND	4	Ground	Ground

PACKAGE THERMAL RESISTANCE FOR TSSOP (PW) PACKAGE⁽¹⁾

CDCS501PW 8-PIN TSSOP			THERMAL AIRFLOW (CFM)				UNIT
			0	150	250	500	
R _{θJA}	High K		149	142	138	132	°C / W
	Low K		230	185	170	150	
R _{θJc}	High K	65					°C / W
	Low K	69					

(1) The package thermal impedance is calculated in accordance with JESD 51 and JEDEC2S2P (high-k board).

ABSOLUTE MAXIMUM RATINGS⁽¹⁾

over operating free-air temperature range (unless otherwise noted)

		VALUE	UNIT
V _{DD}	Supply voltage range	–0.5 to 4.6	V
V _{IN}	Input voltage range	–0.5 to 4.6	V
V _{out}	Output voltage range	–0.5 to 4.6	V
I _{IN}	Input current (V _I < 0, V _I > V _{DD})	20	mA
I _{out}	Continuous output current	50	mA
T _{ST}	Storage temperature range	–65 to 150	°C
T _J	Maximum junction temperature	125	°C

- (1) Stresses beyond those listed under *absolute maximum ratings* may cause permanent damage to the device. These are stress ratings only and functional operation of the device at these or any other conditions beyond those indicated under *recommended operating conditions* is not implied. Exposure to absolute-maximum-rated conditions for extended periods may affect device reliability.

RECOMMENDED OPERATING CONDITIONS

		MIN	NOM	MAX	UNIT
V _{DD}	Supply voltage	3.0		3.6	V
f _{IN}	Input Frequency	40		108	MHz
V _{IL}	Low level input voltage LVCMOS			0.3 V _{DD}	V
V _{IH}	High level input voltage LVCMOS	0.7 V _{DD}			V
V _I	Input Voltage threshold LVCMOS		0.5 V _{DD}		V
C _L	Output Load Test LVCMOS			15	pF
I _{OH} /I _{OL}	Output Current			12	mA
T _A	Operating free-air temperature	–40		85	°C

DEVICE CHARACTERISTICS

over recommended operating free-air temperature range (unless otherwise noted)

PARAMETER		TEST CONDITIONS	MIN	TYP	MAX	UNIT
I_{DD}	Device supply current	$f_{IN} = 80 \text{ MHz}$		26		mA
f_{OUT}	Output frequency		40		108	MHz
I_{IH}	LVC MOS input current	$V_I = V_{DD}; V_{DD} = 3.6V$			10	μA
I_{IL}	LVC MOS input current	$V_I = 0 \text{ V}; V_{DD} = 3.6V$			-10	μA
V_{OH}	LVC MOS high-level output voltage	$I_{OH} = -0.1mA$	2.9			V
		$I_{OH} = -8mA$	2.4			
		$I_{OH} = -12mA$	2.2			
V_{OL}	LVC MOS low-level output voltage	$I_{OL} = 0.1mA$			0.1	V
		$I_{OL} = 8mA$			0.5	
		$I_{OL} = 12mA$			0.8	
$t_{JIT(C-C)}$	Cycle to cycle jitter cycles	$f_{out} = 80 \text{ MHz}; SSC = 1\%, 10000 \text{ cycles}$		110		ps
t_r/t_f	Rise and fall time	20%–80%		0.75		ns
O_{dc}	Output duty cycle		45%		55%	
f_{MOD}	Modulation frequency			30		kHz

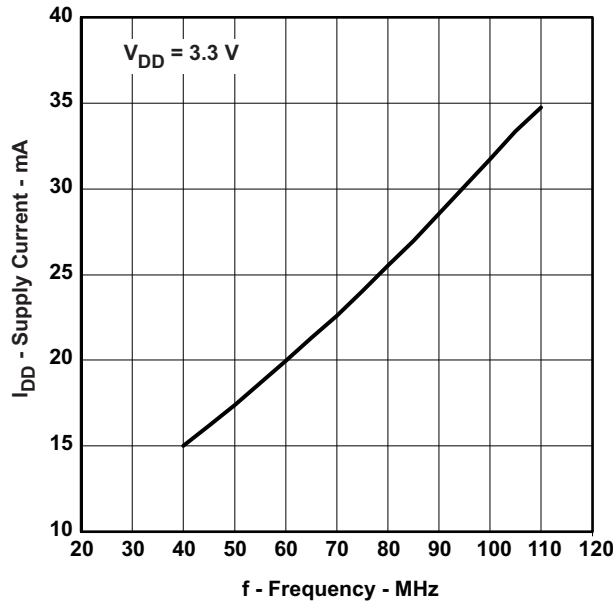

Figure 1. I_{DD} vs. Input Frequency, $V_{DD} = 3.3V$

APPLICATION INFORMATION

SSC MODULATION

The exact implementation of the SSC modulation plays a vital role for the EMI reduction. The CDCS501 uses a triangular modulation scheme implemented in a way that the modulation frequency depends on the VCO frequency of the internal PLL and the spread amount is independent from the VCO frequency.

The modulation frequency can be calculated by using the below formula.

$$f_{\text{mod}} = f_{\text{IN}} / 2480$$

PARAMETER MEASUREMENT INFORMATION

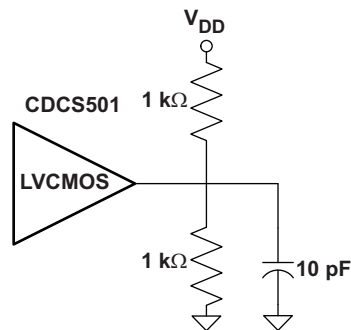

Figure 2. Test Load

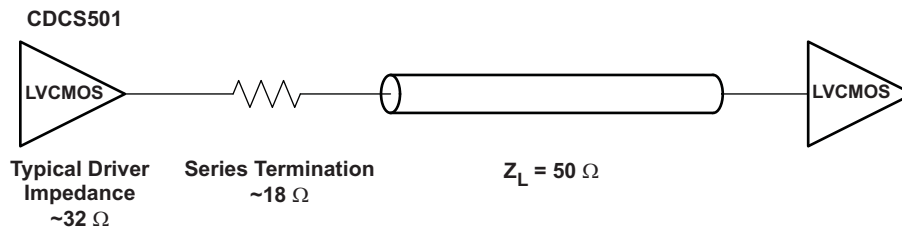

Figure 3. Test Load for 50-Ω Board Environment

PACKAGING INFORMATION

Orderable Device	Status (1)	Package Type	Package Drawing	Pins	Package Qty	Eco Plan (2)	Lead/Ball Finish (6)	MSL Peak Temp (3)	Op Temp (°C)	Device Marking (4/5)	Samples
CDCS501PW	ACTIVE	TSSOP	PW	8	150	Green (RoHS & no Sb/Br)	NIPDAU	Level-1-260C-UNLIM	-40 to 85	CS501	Samples
CDCS501PWR	ACTIVE	TSSOP	PW	8	2000	Green (RoHS & no Sb/Br)	NIPDAU	Level-1-260C-UNLIM	-40 to 85	CS501	Samples

(1) The marketing status values are defined as follows:

ACTIVE: Product device recommended for new designs.

LIFEBUY: TI has announced that the device will be discontinued, and a lifetime-buy period is in effect.

NRND: Not recommended for new designs. Device is in production to support existing customers, but TI does not recommend using this part in a new design.

PREVIEW: Device has been announced but is not in production. Samples may or may not be available.

OBSOLETE: TI has discontinued the production of the device.

(2) **RoHS:** TI defines "RoHS" to mean semiconductor products that are compliant with the current EU RoHS requirements for all 10 RoHS substances, including the requirement that RoHS substance do not exceed 0.1% by weight in homogeneous materials. Where designed to be soldered at high temperatures, "RoHS" products are suitable for use in specified lead-free processes. TI may reference these types of products as "Pb-Free".

RoHS Exempt: TI defines "RoHS Exempt" to mean products that contain lead but are compliant with EU RoHS pursuant to a specific EU RoHS exemption.

Green: TI defines "Green" to mean the content of Chlorine (Cl) and Bromine (Br) based flame retardants meet JS709B low halogen requirements of <=1000ppm threshold. Antimony trioxide based flame retardants must also meet the <=1000ppm threshold requirement.

(3) MSL, Peak Temp. - The Moisture Sensitivity Level rating according to the JEDEC industry standard classifications, and peak solder temperature.

(4) There may be additional marking, which relates to the logo, the lot trace code information, or the environmental category on the device.

(5) Multiple Device Markings will be inside parentheses. Only one Device Marking contained in parentheses and separated by a "~" will appear on a device. If a line is indented then it is a continuation of the previous line and the two combined represent the entire Device Marking for that device.

(6) Lead/Ball Finish - Orderable Devices may have multiple material finish options. Finish options are separated by a vertical ruled line. Lead/Ball Finish values may wrap to two lines if the finish value exceeds the maximum column width.

Important Information and Disclaimer:The information provided on this page represents TI's knowledge and belief as of the date that it is provided. TI bases its knowledge and belief on information provided by third parties, and makes no representation or warranty as to the accuracy of such information. Efforts are underway to better integrate information from third parties. TI has taken and continues to take reasonable steps to provide representative and accurate information but may not have conducted destructive testing or chemical analysis on incoming materials and chemicals. TI and TI suppliers consider certain information to be proprietary, and thus CAS numbers and other limited information may not be available for release.

In no event shall TI's liability arising out of such information exceed the total purchase price of the TI part(s) at issue in this document sold by TI to Customer on an annual basis.

TAPE AND REEL INFORMATION



QUADRANT ASSIGNMENTS FOR PIN 1 ORIENTATION IN TAPE



*All dimensions are nominal

Device	Package Type	Package Drawing	Pins	SPQ	Reel Diameter (mm)	Reel Width W1 (mm)	A0 (mm)	B0 (mm)	K0 (mm)	P1 (mm)	W (mm)	Pin1 Quadrant
CDCS501PWR	TSSOP	PW	8	2000	330.0	12.4	7.0	3.6	1.6	8.0	12.0	Q1

TAPE AND REEL BOX DIMENSIONS



*All dimensions are nominal

Device	Package Type	Package Drawing	Pins	SPQ	Length (mm)	Width (mm)	Height (mm)
CDCS501PWR	TSSOP	PW	8	2000	367.0	367.0	35.0

PW0008A



PACKAGE OUTLINE

TSSOP - 1.2 mm max height

SMALL OUTLINE PACKAGE

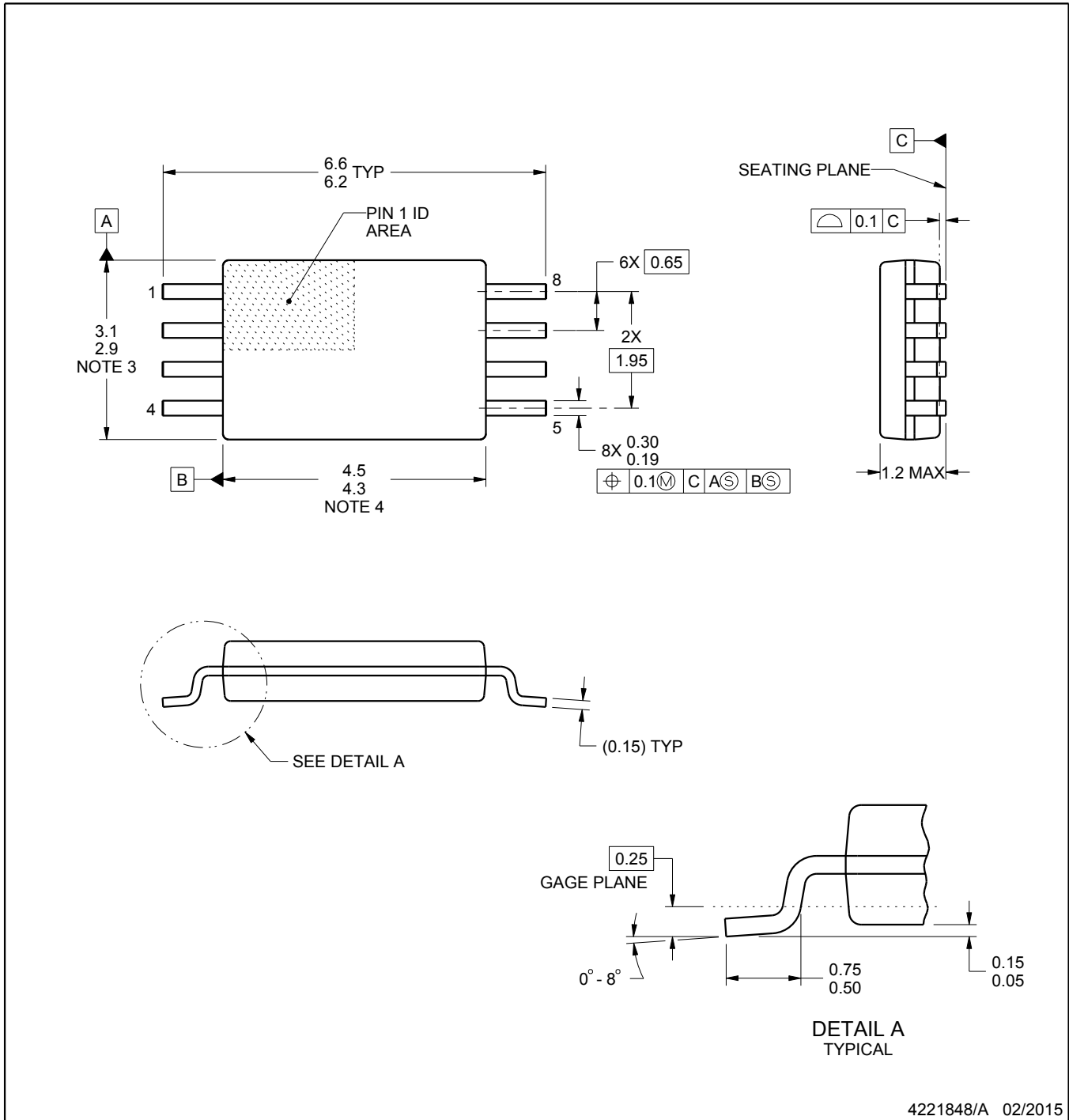

4221848/A 02/2015

NOTES:

1. All linear dimensions are in millimeters. Any dimensions in parenthesis are for reference only. Dimensioning and tolerancing per ASME Y14.5M.
2. This drawing is subject to change without notice.
3. This dimension does not include mold flash, protrusions, or gate burrs. Mold flash, protrusions, or gate burrs shall not exceed 0.15 mm per side.
4. This dimension does not include interlead flash. Interlead flash shall not exceed 0.25 mm per side.
5. Reference JEDEC registration MO-153, variation AA.

EXAMPLE BOARD LAYOUT

PW0008A

TSSOP - 1.2 mm max height

SMALL OUTLINE PACKAGE

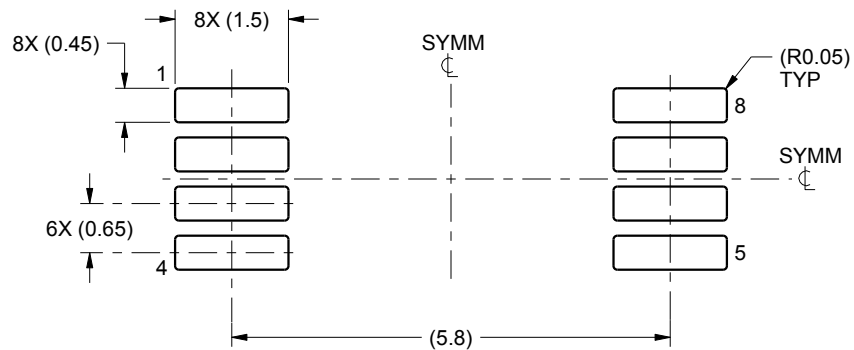

LAND PATTERN EXAMPLE
SCALE:10X

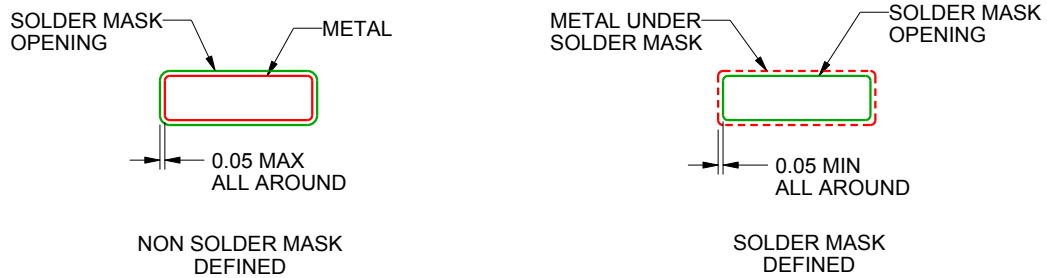

SOLDER MASK DETAILS
NOT TO SCALE

4221848/A 02/2015

NOTES: (continued)

- 6. Publication IPC-7351 may have alternate designs.
- 7. Solder mask tolerances between and around signal pads can vary based on board fabrication site.

EXAMPLE STENCIL DESIGN

PW0008A

TSSOP - 1.2 mm max height

SMALL OUTLINE PACKAGE

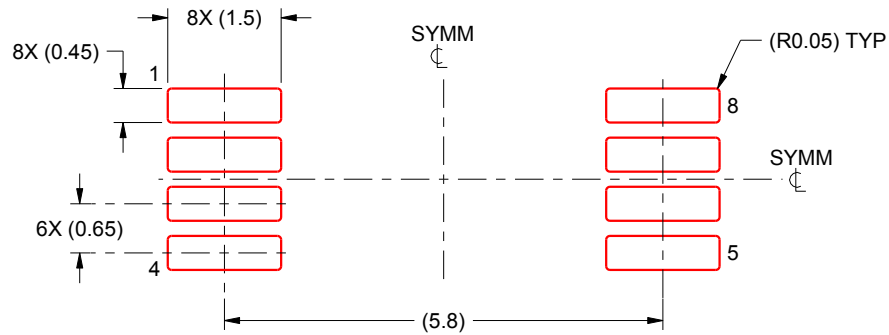

SOLDER PASTE EXAMPLE
BASED ON 0.125 mm THICK STENCIL
SCALE:10X

4221848/A 02/2015

NOTES: (continued)

8. Laser cutting apertures with trapezoidal walls and rounded corners may offer better paste release. IPC-7525 may have alternate design recommendations.
9. Board assembly site may have different recommendations for stencil design.

IMPORTANT NOTICE AND DISCLAIMER

TI PROVIDES TECHNICAL AND RELIABILITY DATA (INCLUDING DATASHEETS), DESIGN RESOURCES (INCLUDING REFERENCE DESIGNS), APPLICATION OR OTHER DESIGN ADVICE, WEB TOOLS, SAFETY INFORMATION, AND OTHER RESOURCES "AS IS" AND WITH ALL FAULTS, AND DISCLAIMS ALL WARRANTIES, EXPRESS AND IMPLIED, INCLUDING WITHOUT LIMITATION ANY IMPLIED WARRANTIES OF MERCHANTABILITY, FITNESS FOR A PARTICULAR PURPOSE OR NON-INFRINGEMENT OF THIRD PARTY INTELLECTUAL PROPERTY RIGHTS.

These resources are intended for skilled developers designing with TI products. You are solely responsible for (1) selecting the appropriate TI products for your application, (2) designing, validating and testing your application, and (3) ensuring your application meets applicable standards, and any other safety, security, or other requirements. These resources are subject to change without notice. TI grants you permission to use these resources only for development of an application that uses the TI products described in the resource. Other reproduction and display of these resources is prohibited. No license is granted to any other TI intellectual property right or to any third party intellectual property right. TI disclaims responsibility for, and you will fully indemnify TI and its representatives against, any claims, damages, costs, losses, and liabilities arising out of your use of these resources.

TI's products are provided subject to TI's Terms of Sale (www.ti.com/legal/termsofsale.html) or other applicable terms available either on ti.com or provided in conjunction with such TI products. TI's provision of these resources does not expand or otherwise alter TI's applicable warranties or warranty disclaimers for TI products.

Mailing Address: Texas Instruments, Post Office Box 655303, Dallas, Texas 75265
Copyright © 2020, Texas Instruments Incorporated