

DS26C31MQML CMOS Quad TRI-STATE Differential Line Driver

 Check for Samples: [DS26C31MQML](#)

FEATURES

- TTL Input Compatible
- Outputs Will Not Load Line When $V_{CC} = 0V$
- Meets the Requirements of EIA Standard RS-422
- Operation from Single 5V Supply
- TRI-STATE Outputs for Connection to System Buses
- Low Quiescent Current

DESCRIPTION

The DS26C31 is a quad differential line driver designed for digital data transmission over balanced lines. The DS26C31 meets all the requirements of EIA standard RS-422 while retaining the low power characteristics of CMOS. The DS26C31 is compatible with EIA standard RS-422; however, one exception in test methodology is taken. This enables the construction of serial and terminal interfaces while maintaining minimal power consumption.

The DS26C31 accepts TTL or CMOS input levels and translates these to RS-422 output levels. This part uses special output circuitry that enables the drivers to power down without loading down the bus. This device has enable and disable circuitry common to all four drivers. The DS26C31 is pin compatible to the AM26LS31 and the DS26LS31.

All inputs are protected against damage due to electrostatic discharge by diodes to V_{CC} and ground.

Connection Diagram

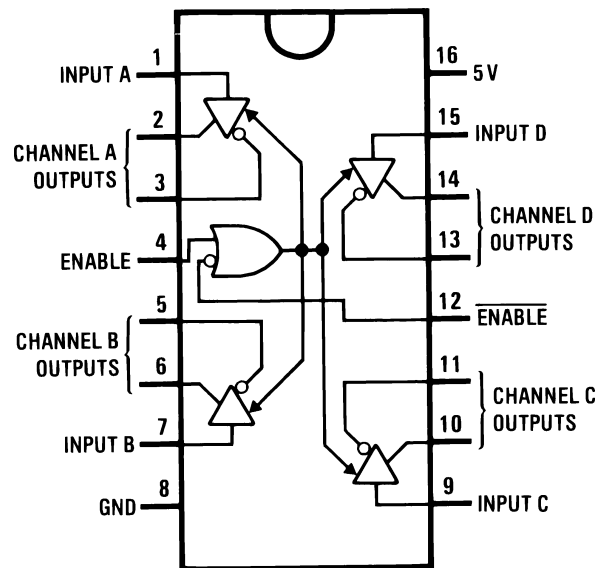

Figure 1. CDIP, CLGA Packages- Top View
See Package Numbers NFE0016A, NAD0016A



Please be aware that an important notice concerning availability, standard warranty, and use in critical applications of Texas Instruments semiconductor products and disclaimers thereto appears at the end of this data sheet.

All trademarks are the property of their respective owners.

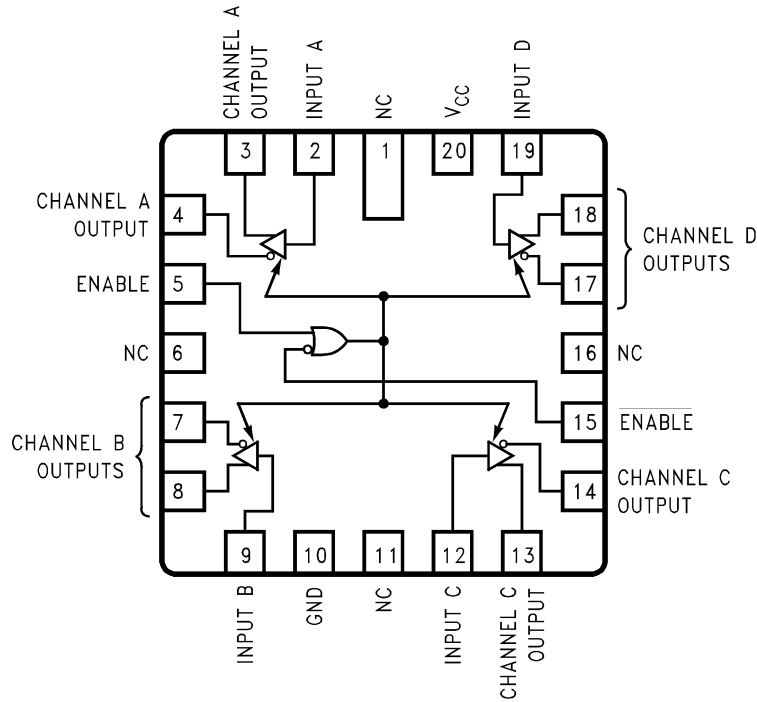
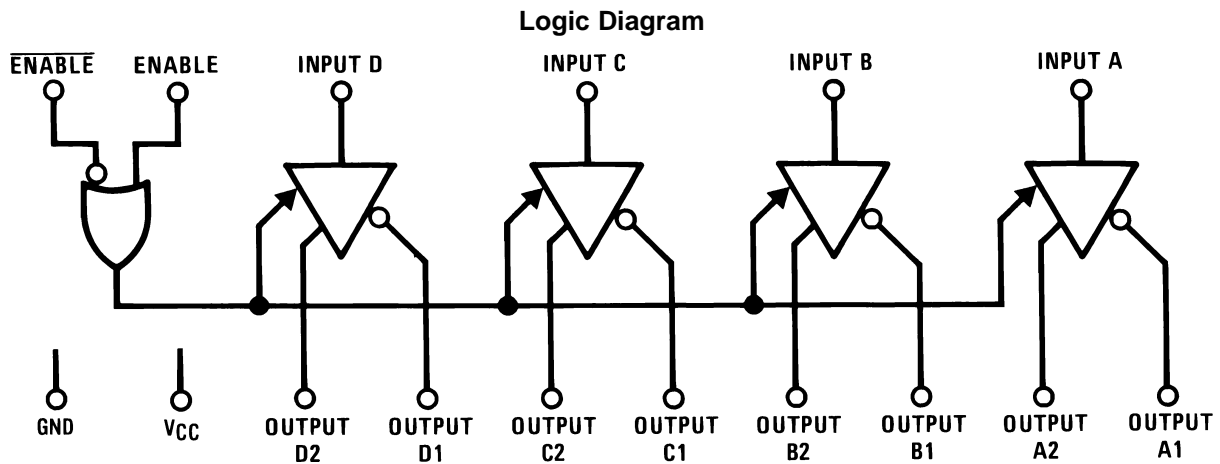

Figure 2. 20-Lead LCCC Package- Top View
See Package Number NAJ0020A



Truth Table ⁽¹⁾

ENABLE	ENABLE	Input	Non-Inverting Output	Inverting Output
L	H	X	Z	Z
All other combinations of enable inputs		L	L	H
		H	H	L

(1) L = Low logic state
X = Irrelevant
H = High logic state
Z = TRI-STATE (high impedance)



These devices have limited built-in ESD protection. The leads should be shorted together or the device placed in conductive foam during storage or handling to prevent electrostatic damage to the MOS gates.

Absolute Maximum Ratings⁽¹⁾⁽²⁾

Supply Voltage (V_{CC})	-0.5V to 7.0V
DC Input Voltage (V_I)	-1.5V to $V_{CC} + 0.5V$
DC Output Voltage (V_O)	-0.5V to 7V
Clamp Diode Current (I_{IK}, I_{OK})	± 20 mA
DC Output Current, per pin (I_O)	± 150 mA
DC V_{CC} or Gnd Current, per pin (I_{CC})	± 150 mA
Storage Temperature Range (T_{Stg})	$-65^\circ\text{C} \leq T_A \leq +150^\circ\text{C}$
Lead Temperature (T_L) Soldering, 4 sec.	260°C

- (1) Absolute Maximum Ratings indicate limits beyond which damage to the device may occur. Operating Ratings indicate conditions for which the device is functional, but do not verify specific performance limits. For verified specifications and test conditions, see the Electrical Characteristics. The verified specifications apply only for the test conditions listed. Some performance characteristics may degrade when the device is not operated under the listed test conditions.
- (2) Unless otherwise specified, all voltages are referenced to ground. All currents into device pins are positive, all currents out of device pins are negative.

Operating Conditions

	Min	Max	Units
Supply Voltage (V_{CC})	4.50	5.50	V
DC Input or Output Voltage (V_I, V_O)	0	V_{CC}	V
Operating Temperature Range (T_A)	-55	+125	°C

Quality Conformance Inspection

Table 1. Mil-Std-883, Method 5005 - Group A

Subgroup	Description	Temp °C
1	Static tests at	+25
2	Static tests at	+125
3	Static tests at	-55
4	Dynamic tests at	+25
5	Dynamic tests at	+125
6	Dynamic tests at	-55
7	Functional tests at	+25
8A	Functional tests at	+125
8B	Functional tests at	-55
9	Switching tests at	+25
10	Switching tests at	+125
11	Switching tests at	-55
12	Settling time at	+25
13	Settling time at	+125
14	Settling time at	-55

DS26C31M Electrical Characteristics DC Parameters

Parameter	Test Conditions	Notes	Min	Max	Unit	Sub-groups
V_{IH}	Logical "1" Input Voltage		2.0		V	1, 2, 3
V_{IL}	Logical "0" Input Voltage			0.8	V	1, 2, 3
V_{OH}	Logical "1" Output Voltage	$V_I = V_{IH}$ or V_{IL} , $V_{CC} = 4.5V$, $I_O = -20mA$	2.5		V	1, 2, 3
V_{OL}	Logical "0" Output Voltage	$V_I = V_{IH}$ or V_{IL} , $I_O = 20mA$, $V_{CC} = 4.5V$		0.5	V	1, 2, 3
V_T	Differential Output Voltage	$R_L = 100\Omega$, $V_{CC} = 4.5V$	(1) 2.0		V	1, 2, 3
$ V_T - \overline{V_T} $	Difference in Differential Output	$R_L = 100\Omega$, $V_{CC} = 4.5V$	(1)	0.4	V	1, 2, 3
V_{OS}	Common Mode Output Voltage	$R_L = 100\Omega$, $V_{CC} = 5.5V$	(1)	3.0	V	1, 2, 3
$ V_{OS} - \overline{V_{OS}} $	Diff in Common Mode Output	$R_L = 100\Omega$, $V_{CC} = 5.5V$	(1)	0.4	V	1, 2, 3
I_I	Input Current	$V_I = V_{CC}$, Gnd, V_{IH} , or V_{IL} , $V_{CC} = 5.5V$		± 1.0	μA	1, 2, 3
I_{CC}	Quiescent Power Supply Current	$I_O = 0\mu A$, $V_I = V_{CC}$ or Gnd, $V_{CC} = 5.5V$	(2)	500	μA	1, 2, 3
		$I_O = 0\mu A$, $V_I = 2.4V$ or $0.5V$, $V_{CC} = 5.5V$	(2)	2.1	mA	1, 2, 3
I_{OZ}	TRI-STATE Output Leakage Current	$V_O = V_{CC}$ or Gnd, Enable = V_{IL} , $V_{CC} = 5.5V$, Enable = V_{IH}		± 5.0	μA	1, 2, 3
I_{SC}	Output Short Circuit Current	$V_I = V_{CC}$ or Gnd, $V_{CC} = 5.5V$	(1), (3) -30	-150	mA	1, 2, 3
I_{Off}	Output Leakage Current "Power Off"	$V_{CC} = 0V$, $V_O = 6V$		100	μA	1, 2, 3
		$V_{CC} = 0V$, $V_O = 0V$		-100	μA	1, 2, 3

(1) See EIA Specification RS-422 for exact test conditions.

(2) Measured per input. All other inputs at V_{CC} or GND.

(3) This is the current sourced when a high output is shorted to ground. Only one output at a time should be shorted.

DS26C31M Electrical Characteristics AC Parameters - Propagation Delay Time (see Figure 26)

The following conditions apply, unless otherwise specified. $V_{CC} = 5V$, $t_R \leq 6ns$, $t_F \leq 6ns$

Parameter	Test Conditions	Notes	Min	Max	Unit	Sub-groups
t_{PLH}	Input to Output Prop Delay	Figure 27		14	ns	9, 10, 11
t_{PHL}	Input to Output Prop Delay	Figure 27		14	ns	9, 10, 11
	Skew	(1)		3.0	ns	9, 10, 11
t_{TLH}	Output Rise Time	Figure 29		14	ns	9, 10, 11
t_{THL}	Output Fall Time	Figure 29		14	ns	9, 10, 11
t_{PZH}	Output Enable Time	Figure 28		22	ns	9, 10, 11
t_{PZL}	Output Enable Time	Figure 28		28	ns	9, 10, 11
t_{PHZ}	Output Disable Time	Figure 28	(2)	12	ns	9, 10, 11
t_{PLZ}	Output Disable Time	Figure 28	(2)	14	ns	9, 10, 11

(1) Skew is defined as the difference in propagation delays between complimentary outputs at the 50% point.

(2) Output disable time is the delay from ENABLE or \overline{ENABLE} being switched to the output transistors turning off.

Typical Performance Characteristics

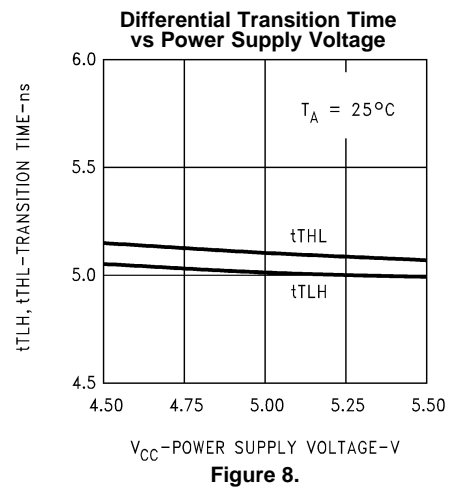
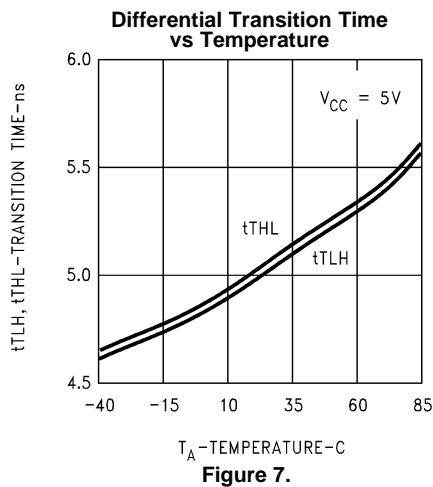
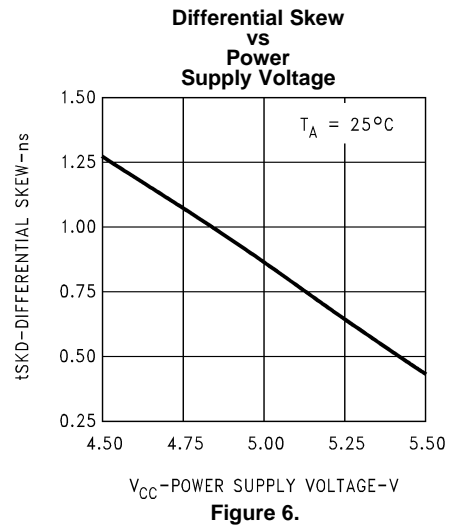
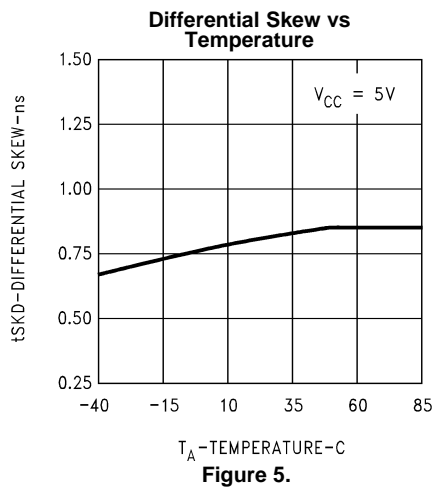
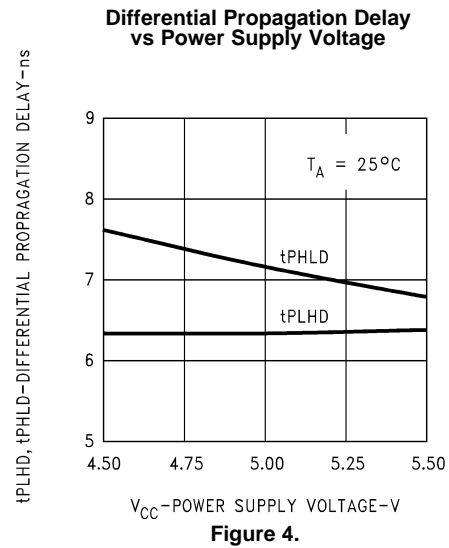
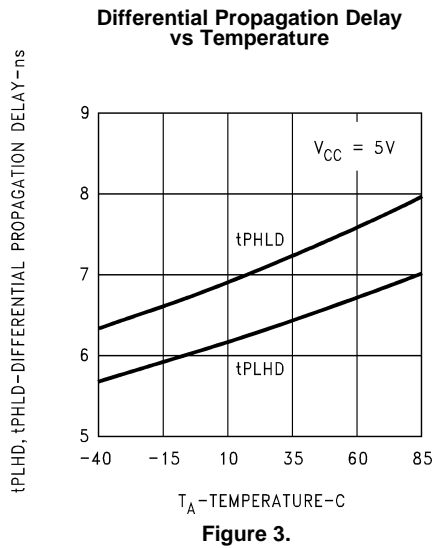

Typical Performance Characteristics (continued)

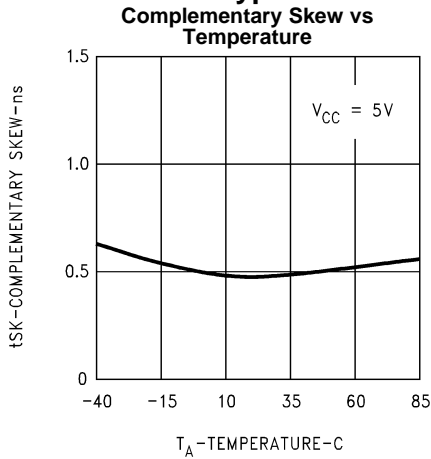

Figure 9.

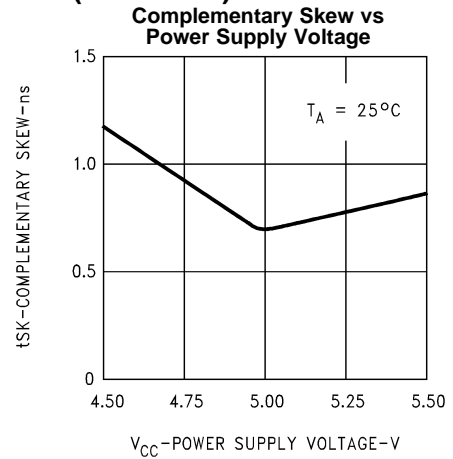

Figure 10.

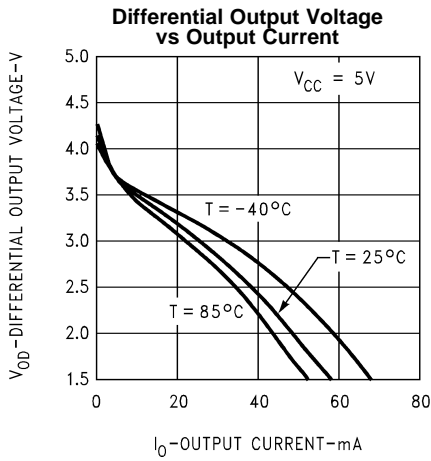

Figure 11.

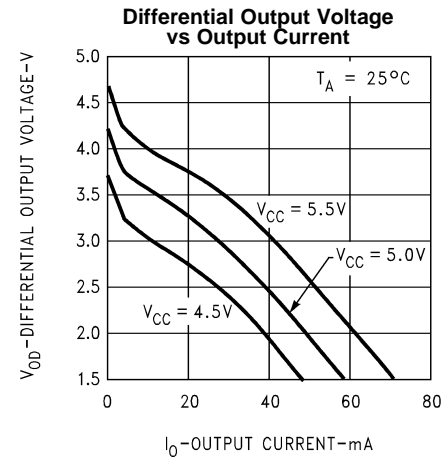

Figure 12.

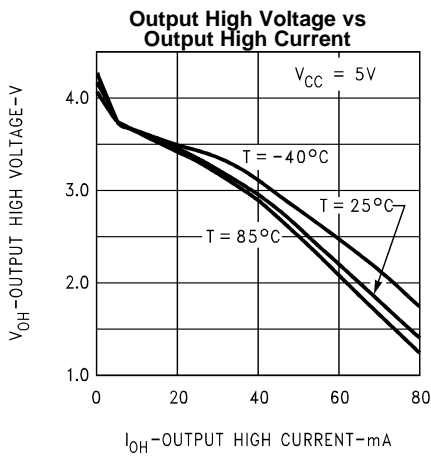

Figure 13.

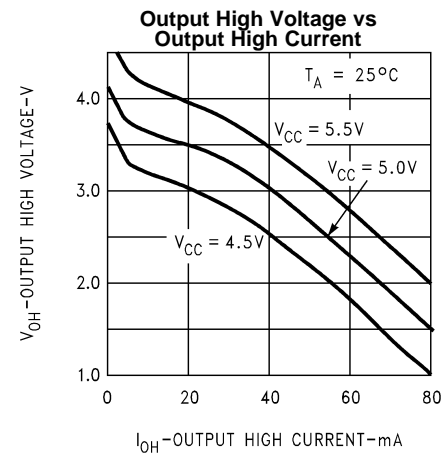

Figure 14.

Typical Performance Characteristics (continued)

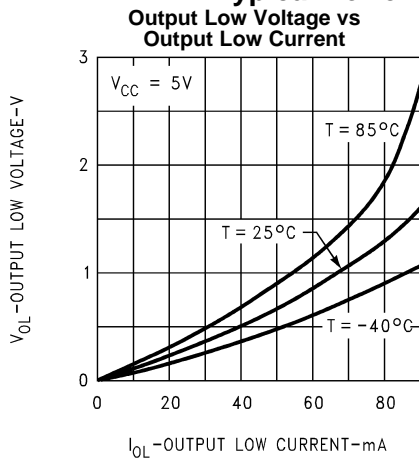

Figure 15.

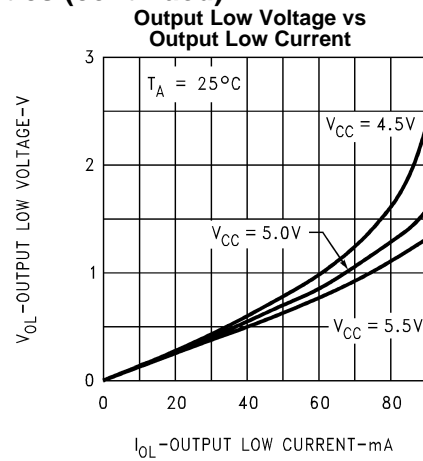

Figure 16.

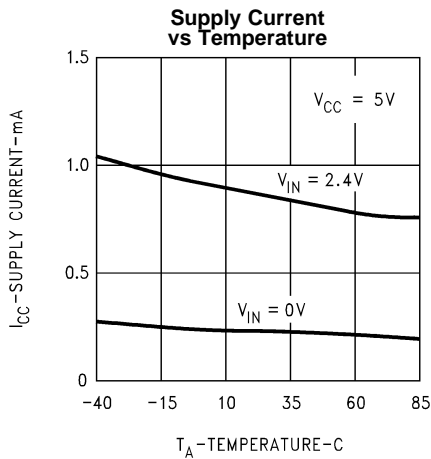

Figure 17.

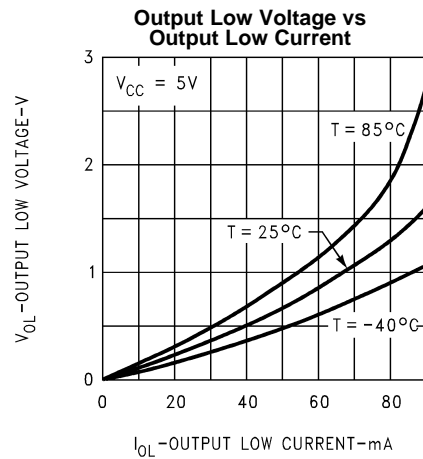

Figure 18.

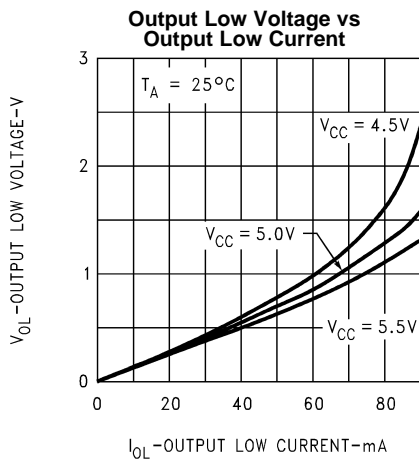

Figure 19.

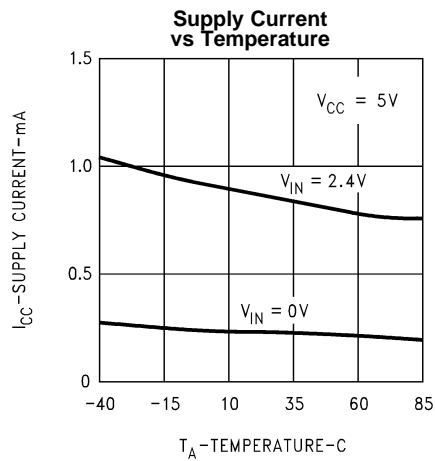

Figure 20.

Typical Performance Characteristics (continued)

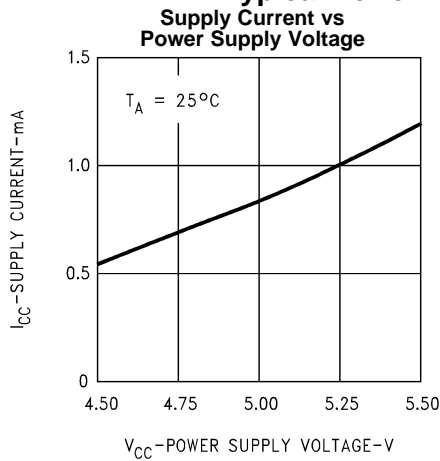

Figure 21.

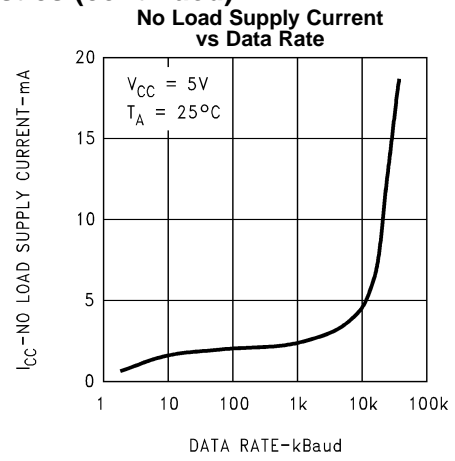

Figure 22.

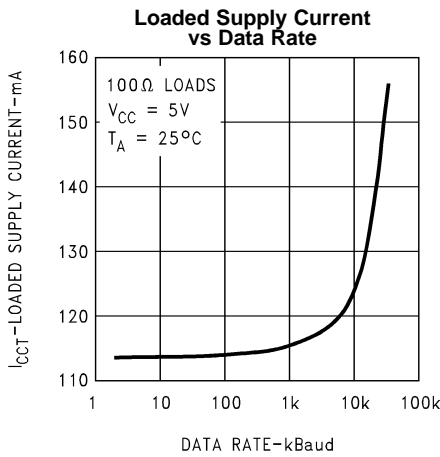

Figure 23.

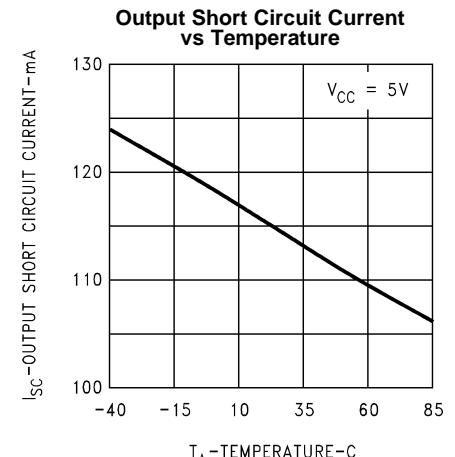

Figure 24.

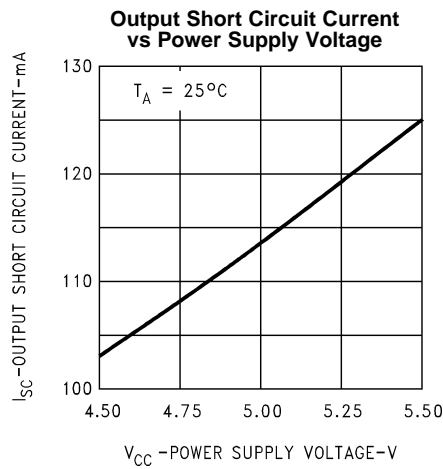
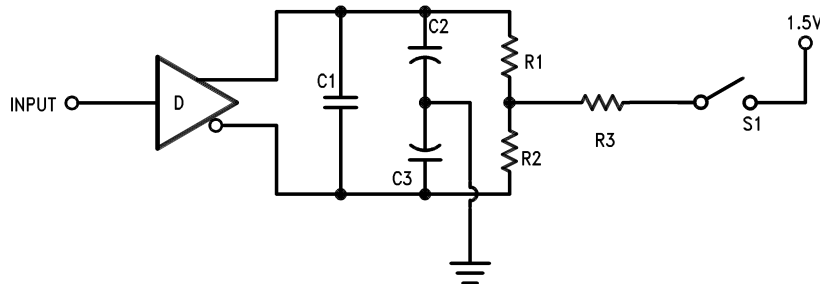

Figure 25.

AC TEST CIRCUIT AND SWITCHING TIME WAVEFORMS



Note: C1 = C2 = C3 = 40 pF (Including Probe and Jig Capacitance), R1 = R2 = 50Ω, R3 = 500Ω.

Figure 26. AC Test Circuit

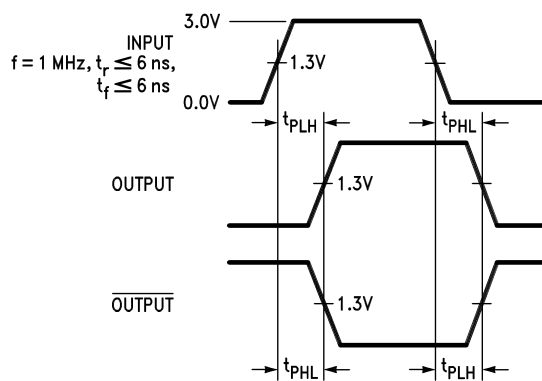

Figure 27. Propagation Delays

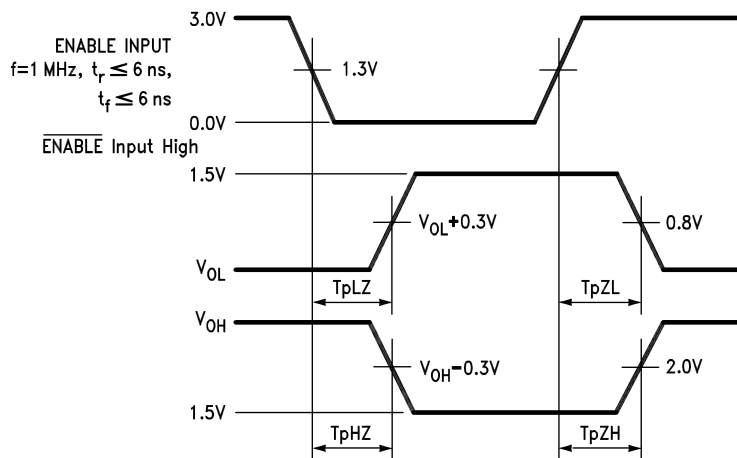
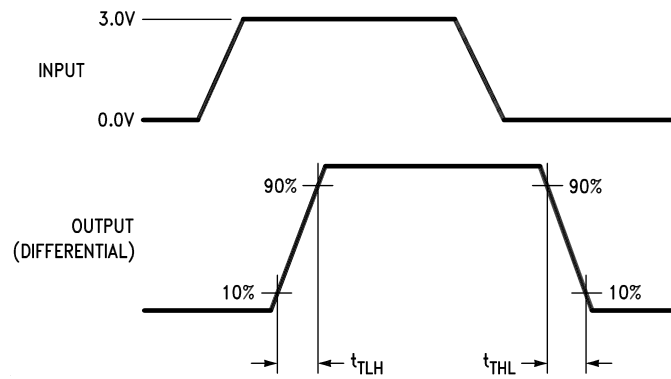

Figure 28. Enable and Disable Times



Input pulse; $f = 1 \text{ MHz}$, 50%; $t_r \leq 6 \text{ ns}$, $t_f \leq 6 \text{ ns}$

Figure 29. Differential Rise and Fall Times

TYPICAL APPLICATIONS

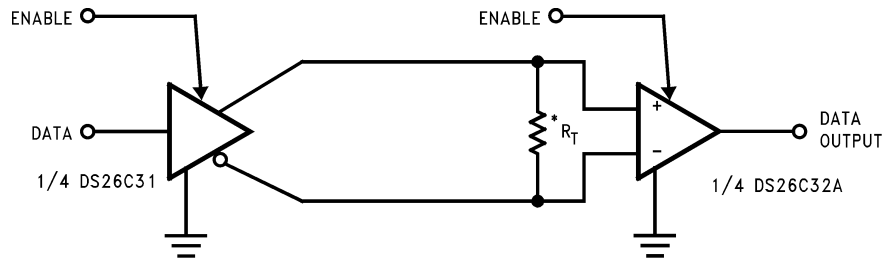

* R_T is optional although highly recommended to reduce reflection.

Figure 30. Two-Wire Balanced System, RS-422

REVISION HISTORY



Table 2. Revision History

Released	Revision	Section	Changes
10/26/2010	A	New Release, Corporate format	1 MDS data sheets converted into one Corp. data sheet format. MNDS26C31M-X Rev 0B0 will be archived.

Changes from Original (April 2013) to Revision A
Page

-
- Changed layout of National Data Sheet to TI format [10](#)
-

PACKAGING INFORMATION

Orderable Device	Status (1)	Package Type	Package Drawing	Pins	Package Qty	Eco Plan (2)	Lead/Ball Finish (6)	MSL Peak Temp (3)	Op Temp (°C)	Device Marking (4/5)	Samples
DS26C31ME/883	ACTIVE	LCCC	NAJ	20	50	TBD	Call TI	Call TI	-55 to 125	DS26C31ME/ 883 Q 5962-91639 01M2A ACO 01M2A >T	
DS26C31MJ/883	ACTIVE	CDIP	NFE	16	25	TBD	Call TI	Call TI	-55 to 125	DS26C31MJ/883 5962-9163901MEA Q	
DS26C31MW/883	ACTIVE	CFP	NAD	16	19	TBD	Call TI	Call TI	-55 to 125	DS26C31MW /883 Q 5962-91639 01MFA ACO 01MFA >T	

(1) The marketing status values are defined as follows:

ACTIVE: Product device recommended for new designs.

LIFEBUY: TI has announced that the device will be discontinued, and a lifetime-buy period is in effect.

NRND: Not recommended for new designs. Device is in production to support existing customers, but TI does not recommend using this part in a new design.

PREVIEW: Device has been announced but is not in production. Samples may or may not be available.

OBSOLETE: TI has discontinued the production of the device.

(2) Eco Plan - The planned eco-friendly classification: Pb-Free (RoHS), Pb-Free (RoHS Exempt), or Green (RoHS & no Sb/Br) - please check <http://www.ti.com/productcontent> for the latest availability information and additional product content details.

TBD: The Pb-Free/Green conversion plan has not been defined.

Pb-Free (RoHS): TI's terms "Lead-Free" or "Pb-Free" mean semiconductor products that are compatible with the current RoHS requirements for all 6 substances, including the requirement that lead not exceed 0.1% by weight in homogeneous materials. Where designed to be soldered at high temperatures, TI Pb-Free products are suitable for use in specified lead-free processes.

Pb-Free (RoHS Exempt): This component has a RoHS exemption for either 1) lead-based flip-chip solder bumps used between the die and package, or 2) lead-based die adhesive used between the die and leadframe. The component is otherwise considered Pb-Free (RoHS compatible) as defined above.

Green (RoHS & no Sb/Br): TI defines "Green" to mean Pb-Free (RoHS compatible), and free of Bromine (Br) and Antimony (Sb) based flame retardants (Br or Sb do not exceed 0.1% by weight in homogeneous material)

(3) MSL, Peak Temp. - The Moisture Sensitivity Level rating according to the JEDEC industry standard classifications, and peak solder temperature.

(4) There may be additional marking, which relates to the logo, the lot trace code information, or the environmental category on the device.

(5) Multiple Device Markings will be inside parentheses. Only one Device Marking contained in parentheses and separated by a "-" will appear on a device. If a line is indented then it is a continuation of the previous line and the two combined represent the entire Device Marking for that device.

⁽⁶⁾ Lead/Ball Finish - Orderable Devices may have multiple material finish options. Finish options are separated by a vertical ruled line. Lead/Ball Finish values may wrap to two lines if the finish value exceeds the maximum column width.

Important Information and Disclaimer:The information provided on this page represents TI's knowledge and belief as of the date that it is provided. TI bases its knowledge and belief on information provided by third parties, and makes no representation or warranty as to the accuracy of such information. Efforts are underway to better integrate information from third parties. TI has taken and continues to take reasonable steps to provide representative and accurate information but may not have conducted destructive testing or chemical analysis on incoming materials and chemicals. TI and TI suppliers consider certain information to be proprietary, and thus CAS numbers and other limited information may not be available for release.

In no event shall TI's liability arising out of such information exceed the total purchase price of the TI part(s) at issue in this document sold by TI to Customer on an annual basis.

NFE0016A

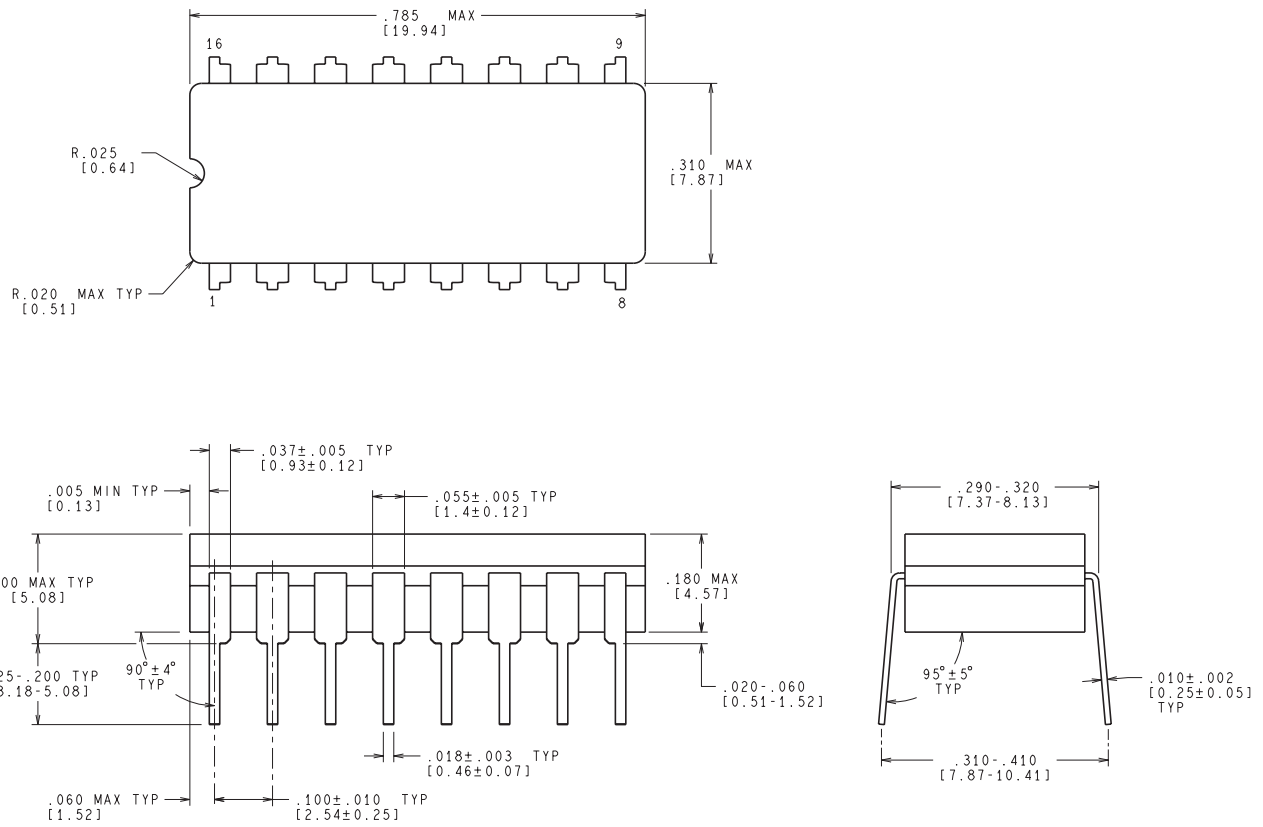

CONTROLLING DIMENSION IS INCH
VALUES IN [] ARE MILLIMETERS

J16A (REV L)

NAD0016A

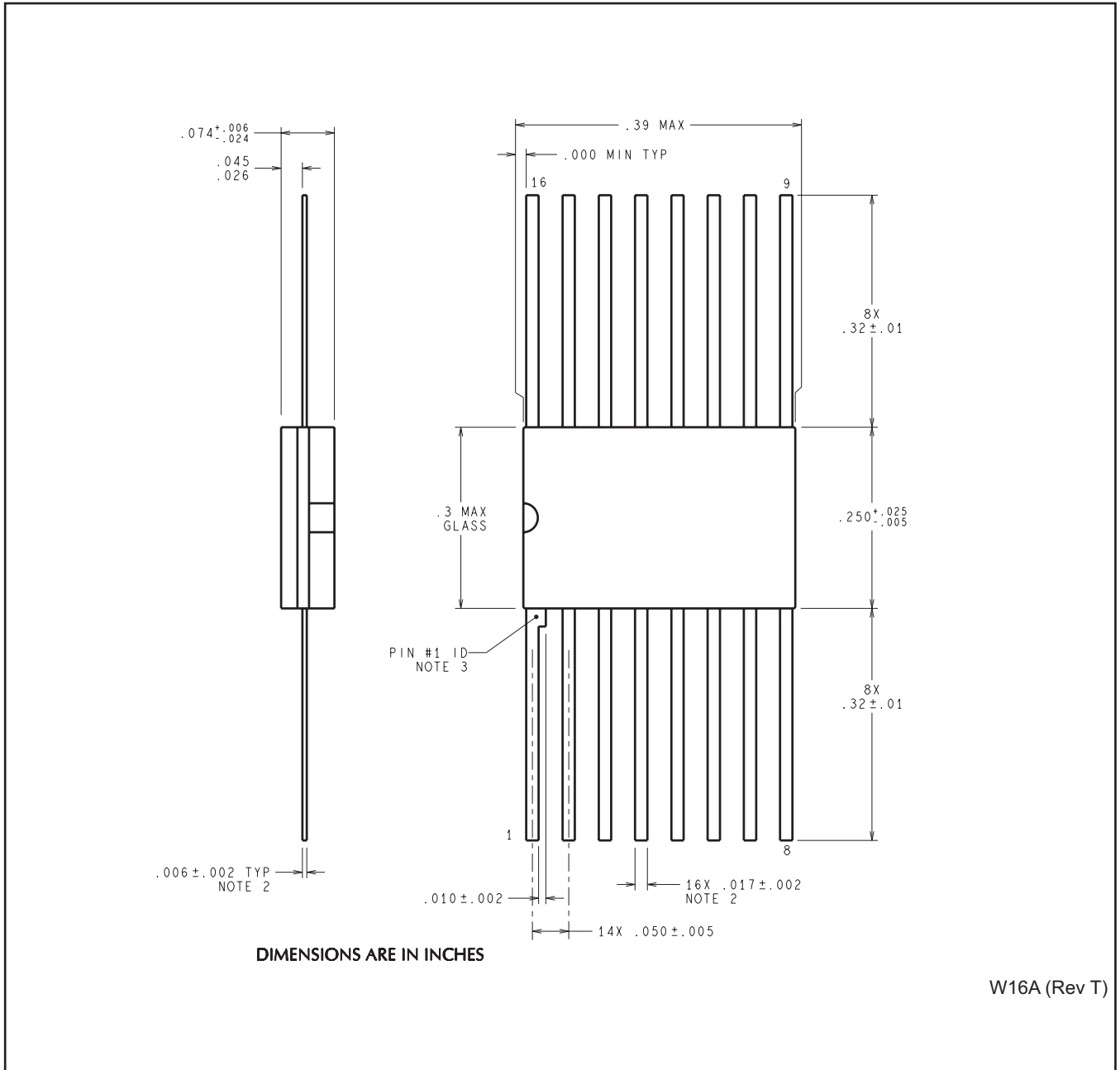

NAJ0020A

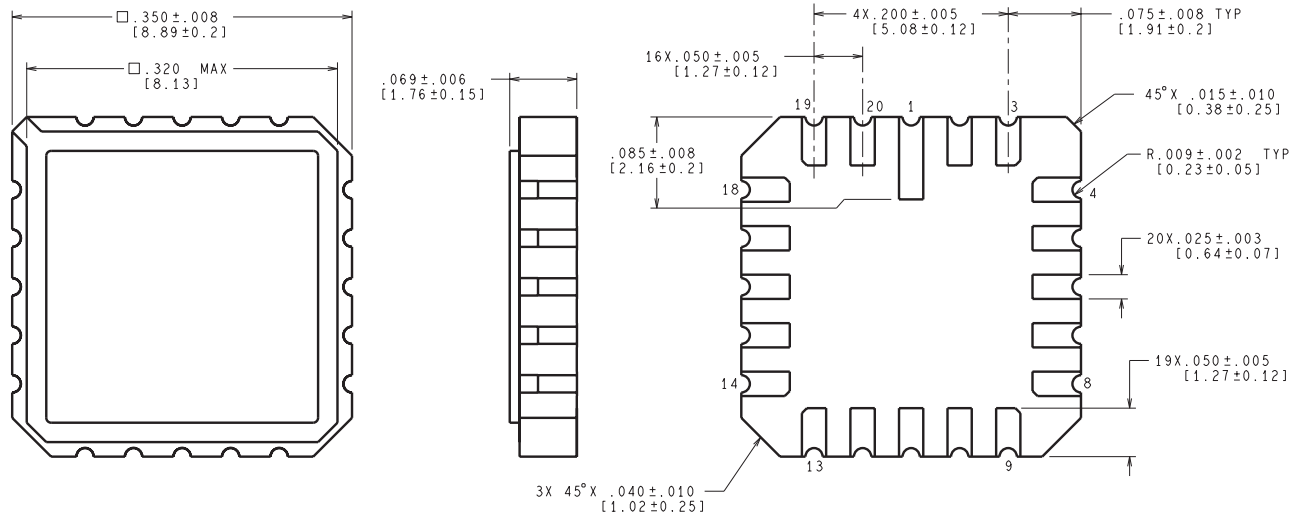

CONTROLLING DIMENSION IS INCH
 VALUES IN [] ARE MILLIMETERS

E20A (Rev F)

IMPORTANT NOTICE

Texas Instruments Incorporated and its subsidiaries (TI) reserve the right to make corrections, enhancements, improvements and other changes to its semiconductor products and services per JESD46, latest issue, and to discontinue any product or service per JESD48, latest issue. Buyers should obtain the latest relevant information before placing orders and should verify that such information is current and complete. All semiconductor products (also referred to herein as "components") are sold subject to TI's terms and conditions of sale supplied at the time of order acknowledgment.

TI warrants performance of its components to the specifications applicable at the time of sale, in accordance with the warranty in TI's terms and conditions of sale of semiconductor products. Testing and other quality control techniques are used to the extent TI deems necessary to support this warranty. Except where mandated by applicable law, testing of all parameters of each component is not necessarily performed.

TI assumes no liability for applications assistance or the design of Buyers' products. Buyers are responsible for their products and applications using TI components. To minimize the risks associated with Buyers' products and applications, Buyers should provide adequate design and operating safeguards.

TI does not warrant or represent that any license, either express or implied, is granted under any patent right, copyright, mask work right, or other intellectual property right relating to any combination, machine, or process in which TI components or services are used. Information published by TI regarding third-party products or services does not constitute a license to use such products or services or a warranty or endorsement thereof. Use of such information may require a license from a third party under the patents or other intellectual property of the third party, or a license from TI under the patents or other intellectual property of TI.

Reproduction of significant portions of TI information in TI data books or data sheets is permissible only if reproduction is without alteration and is accompanied by all associated warranties, conditions, limitations, and notices. TI is not responsible or liable for such altered documentation. Information of third parties may be subject to additional restrictions.

Resale of TI components or services with statements different from or beyond the parameters stated by TI for that component or service voids all express and any implied warranties for the associated TI component or service and is an unfair and deceptive business practice. TI is not responsible or liable for any such statements.

Buyer acknowledges and agrees that it is solely responsible for compliance with all legal, regulatory and safety-related requirements concerning its products, and any use of TI components in its applications, notwithstanding any applications-related information or support that may be provided by TI. Buyer represents and agrees that it has all the necessary expertise to create and implement safeguards which anticipate dangerous consequences of failures, monitor failures and their consequences, lessen the likelihood of failures that might cause harm and take appropriate remedial actions. Buyer will fully indemnify TI and its representatives against any damages arising out of the use of any TI components in safety-critical applications.

In some cases, TI components may be promoted specifically to facilitate safety-related applications. With such components, TI's goal is to help enable customers to design and create their own end-product solutions that meet applicable functional safety standards and requirements. Nonetheless, such components are subject to these terms.

No TI components are authorized for use in FDA Class III (or similar life-critical medical equipment) unless authorized officers of the parties have executed a special agreement specifically governing such use.

Only those TI components which TI has specifically designated as military grade or "enhanced plastic" are designed and intended for use in military/aerospace applications or environments. Buyer acknowledges and agrees that any military or aerospace use of TI components which have **not** been so designated is solely at the Buyer's risk, and that Buyer is solely responsible for compliance with all legal and regulatory requirements in connection with such use.

TI has specifically designated certain components as meeting ISO/TS16949 requirements, mainly for automotive use. In any case of use of non-designated products, TI will not be responsible for any failure to meet ISO/TS16949.

Products

Audio	www.ti.com/audio
Amplifiers	amplifier.ti.com
Data Converters	dataconverter.ti.com
DLP® Products	www.dlp.com
DSP	dsp.ti.com
Clocks and Timers	www.ti.com/clocks
Interface	interface.ti.com
Logic	logic.ti.com
Power Mgmt	power.ti.com
Microcontrollers	microcontroller.ti.com
RFID	www.ti-rfid.com
OMAP Applications Processors	www.ti.com/omap
Wireless Connectivity	www.ti.com/wirelessconnectivity

Applications

Automotive and Transportation	www.ti.com/automotive
Communications and Telecom	www.ti.com/communications
Computers and Peripherals	www.ti.com/computers
Consumer Electronics	www.ti.com/consumer-apps
Energy and Lighting	www.ti.com/energy
Industrial	www.ti.com/industrial
Medical	www.ti.com/medical
Security	www.ti.com/security
Space, Avionics and Defense	www.ti.com/space-avionics-defense
Video and Imaging	www.ti.com/video

TI E2E Community

e2e.ti.com