

KS SERIES KEY SWITCHES

New!

FEATURES



- Single pole single throw momentary action.
- Excellent tactile feed-back (Snap dome).
- Compact size.
- Long operating life for high reliability.
- Available in choice of 7 cosmetic colors.
- Textured actuator surface for non-slip operation.
- Molded-in terminals minimize wicking of flux or solder.

MATERIALS

Base: ABS 777, color white.
 Actuator: Polycarbonate, 7 optional colors (see model tabulations).
 Terminals: Silver plated brass.
 Shorting Contact: Silver plated phosphor bronze.

SPECIFICATIONS SUBJECT TO CHANGE WITHOUT NOTICE.

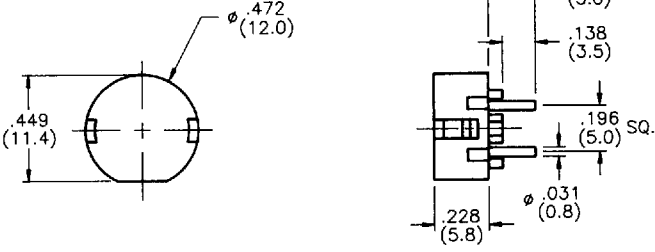
GENERAL SPECIFICATIONS	
ELECTRICALS	
Contact rating:	10 mA @ 35 VDC
Insulation resistance:	100 megohms min. (500 VDC)
Dielectric withstanding voltage:	500 VAC for 1 minute
Contact resistance:	< 20 milliohms
Electrical life:	100,000 cycles min.
Contact bounce:	less than 10 msec.
MECHANICALS, THERMALS	
Plunger travel:	.031" (0.8mm)
Actuation force:	130 grams ± 30 grams
Operating temperature range:	-20°C to +65°C
SOLDERING	
Wave or hand soldering:	235°C max. for 5 seconds max..
Solvent washing:	Non-washable.

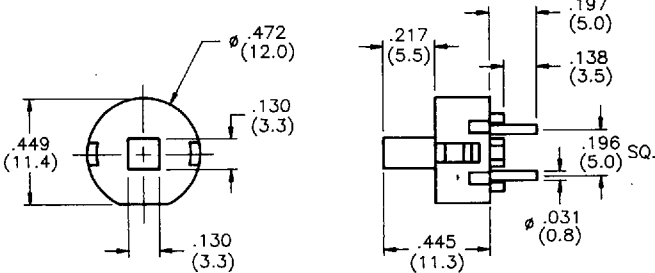
<p>KSL</p> 		<table border="1"> <thead> <tr> <th>Model No.</th> <th>Actuator Color</th> </tr> </thead> <tbody> <tr><td>KSL1</td><td>Blue</td></tr> <tr><td>KSL2</td><td>Black</td></tr> <tr><td>KSL3</td><td>Green</td></tr> <tr><td>KSL4</td><td>Gray</td></tr> <tr><td>KSL5</td><td>Yellow</td></tr> <tr><td>KSL6</td><td>Red</td></tr> <tr><td>KSL8</td><td>White</td></tr> </tbody> </table>	Model No.	Actuator Color	KSL1	Blue	KSL2	Black	KSL3	Green	KSL4	Gray	KSL5	Yellow	KSL6	Red	KSL8	White
Model No.	Actuator Color																	
KSL1	Blue																	
KSL2	Black																	
KSL3	Green																	
KSL4	Gray																	
KSL5	Yellow																	
KSL6	Red																	
KSL8	White																	
<p>KSP</p> 		<table border="1"> <thead> <tr> <th>Model No.</th> <th>Actuator Color</th> </tr> </thead> <tbody> <tr><td>KSP1</td><td>Blue</td></tr> <tr><td>KSP2</td><td>Black</td></tr> <tr><td>KSP3</td><td>Green</td></tr> <tr><td>KSP4</td><td>Gray</td></tr> <tr><td>KSP5</td><td>Yellow</td></tr> <tr><td>KSP6</td><td>Red</td></tr> <tr><td>KSP8</td><td>White</td></tr> </tbody> </table>	Model No.	Actuator Color	KSP1	Blue	KSP2	Black	KSP3	Green	KSP4	Gray	KSP5	Yellow	KSP6	Red	KSP8	White
Model No.	Actuator Color																	
KSP1	Blue																	
KSP2	Black																	
KSP3	Green																	
KSP4	Gray																	
KSP5	Yellow																	
KSP6	Red																	
KSP8	White																	

D 96E ■ 6346802 0001433 467 ■

SPECIFICATIONS SUBJECT TO CHANGE WITHOUT NOTICE.

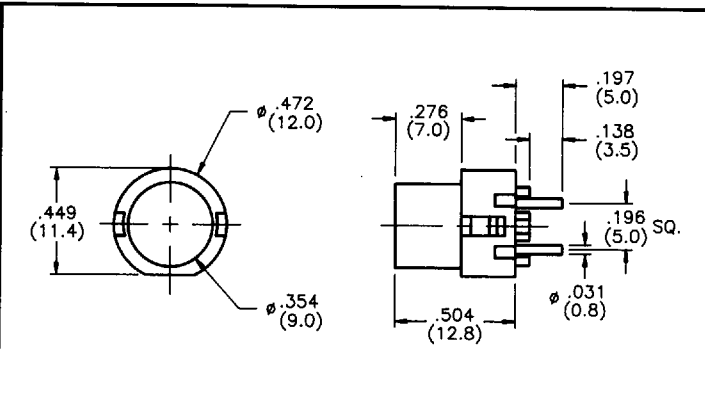
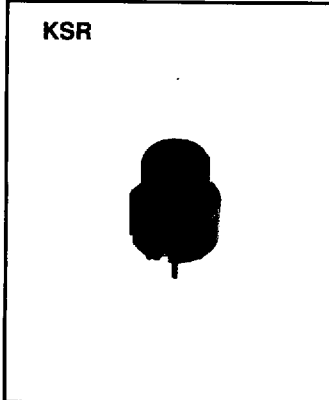

Model No.	Actuator Color
KSR1	Blue
KSR2	Black
KSR3	Green
KSR4	Gray
KSR5	Yellow
KSR6	Red
KSR8	White

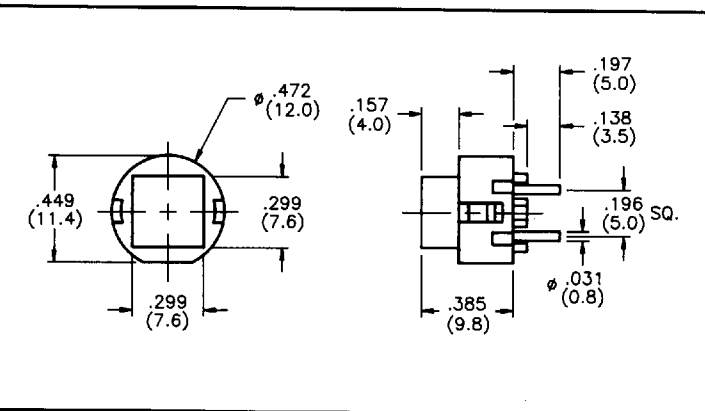
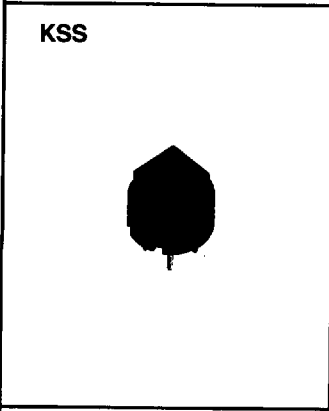

Model No.	Actuator Color
KSS1	Blue
KSS2	Black
KSS3	Green
KSS4	Gray
KSS5	Yellow
KSS6	Red
KSS8	White

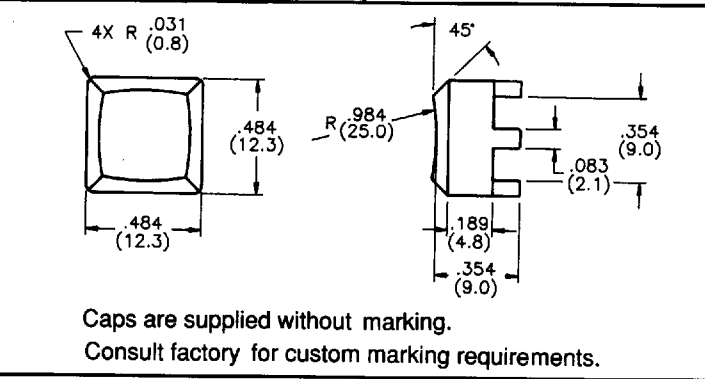
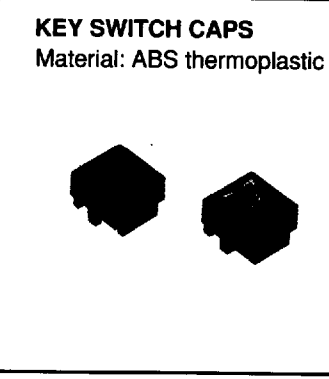
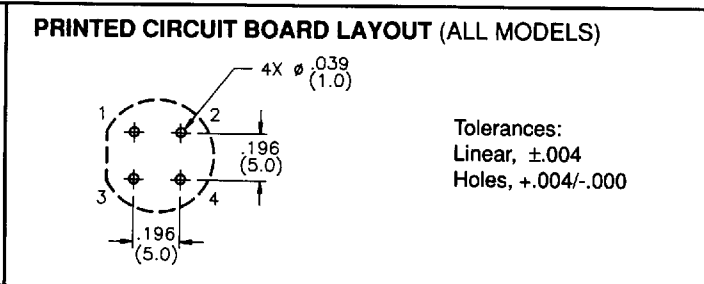
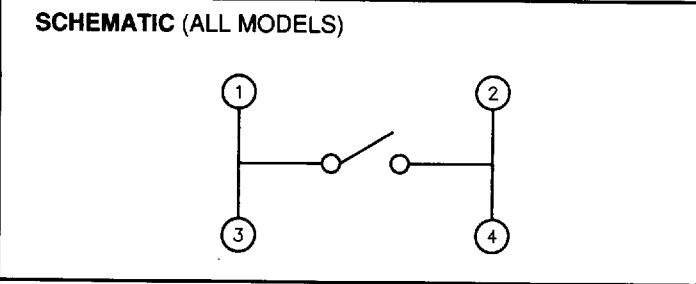

Model No.	Cap Color
K1	Blue
K2	Black
K3	Green
K4	Gray
K5	Yellow
K6	Red
K8	White

Caps are supplied without marking.
 Consult factory for custom marking requirements.

(Fits KSL & KSS models only)

D 96E ■ 6346802 0001434 3T3 ■