

2SC3189



2010A

NPN Epitaxial Planar Silicon Transistor



CRT Display Horizontal Deflection Output Applications

©1313A

Features

- . High switching speed.
- . Especially suited for high-definition CRT displays.
- . Wide ASO and highly resistant to breakdown.

Absolute Maximum Ratings at $T_a=25^\circ\text{C}$

			unit
Collector to Base Voltage	V_{CB0}	250	V
Collector to Emitter Voltage	V_{CEO}	100	V
Emitter to Base Voltage	V_{EBO}	6	V
Collector Current	I_C	7.5	A
Peak Collector Current	i_{cp}	15	A
Base Current	I_B	4	A
Collector Dissipation	P_C	50	W
Junction Temperature	T_j	150	$^\circ\text{C}$
Storage Temperature	T_{stg}	-55 to +150	$^\circ\text{C}$

Electrical Characteristics at $T_a=25^\circ\text{C}$

			min	typ	max	unit
Collector Cutoff Current	I_{CBO}	$V_{CB}=200\text{V}, I_E=0$			100	μA
Emitter Cutoff Current	I_{EBO}	$V_{EB}=5\text{V}, I_C=0$			100	μA
DC Current Gain	h_{FE}	$V_{CE}=5\text{V}, I_C=5\text{A}$	15		75	
Gain Bandwidth Product	f_T	$V_{CE}=10\text{V}, I_C=0.5\text{A}$	10	40		MHz
Collector to Emitter Saturation Voltage	$V_{CE(sat)}$	$I_C=5\text{A}, I_B=0.5\text{A}$			1.2	V
Base to Emitter Saturation Voltage	$V_{BE(sat)}$	$I_C=5\text{A}, I_B=0.5\text{A}$			1.2	V
Collector to Base Breakdown Voltage	$V_{(BR)CBO}$	$I_C=1\text{mA}, I_E=0$	250			V
Collector to Emitter Breakdown Voltage	$V_{(BR)CEO}$	$I_C=1\text{mA}, R_{BE}=\infty$	100			V
Emitter to Base Breakdown Voltage	$V_{(BR)EBO}$	$I_E=1\text{mA}, I_C=0$	6			V
Fall Time	t_f	$I_C=5\text{A}, I_{B1}=-I_{B2}=0.5\text{A}$			0.5	μs

Switching Time Test Circuit

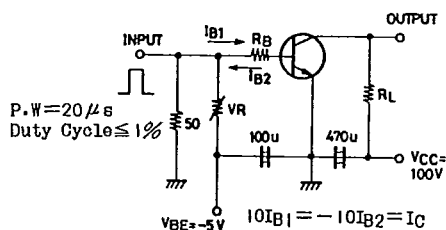

Case Outline 2010A (unit:mm)

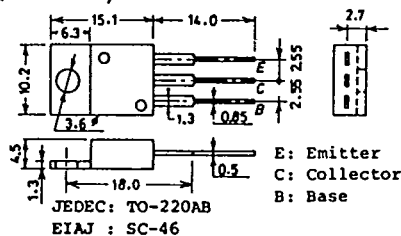

E: Emitter
C: Collector
B: Base

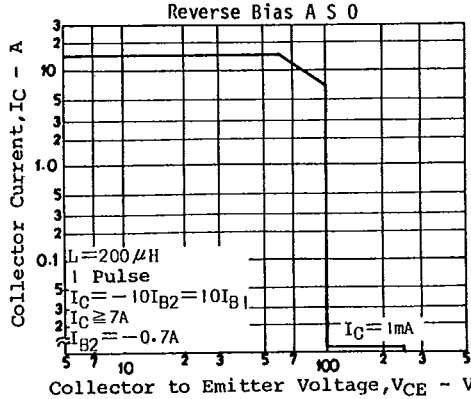
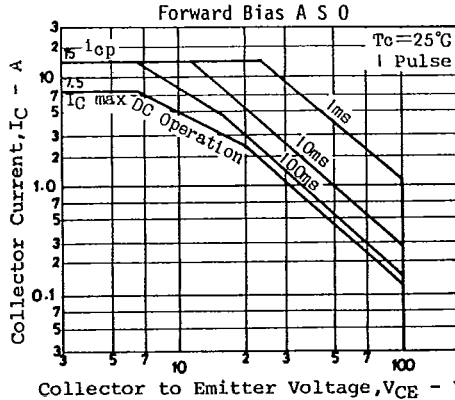
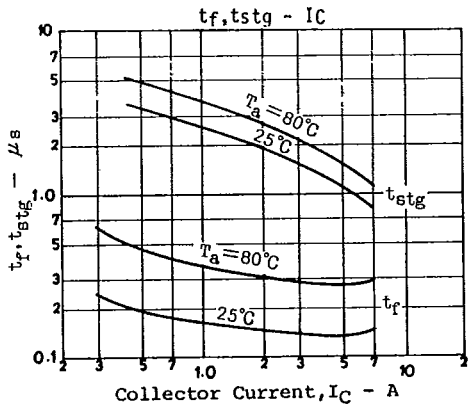
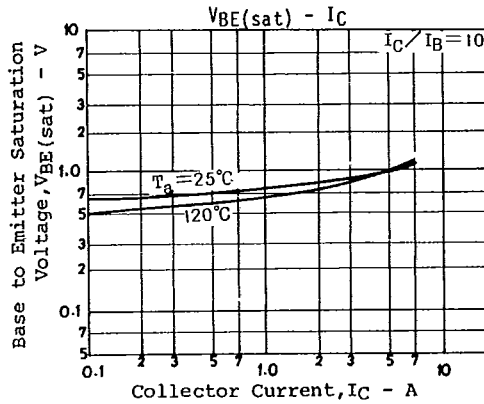
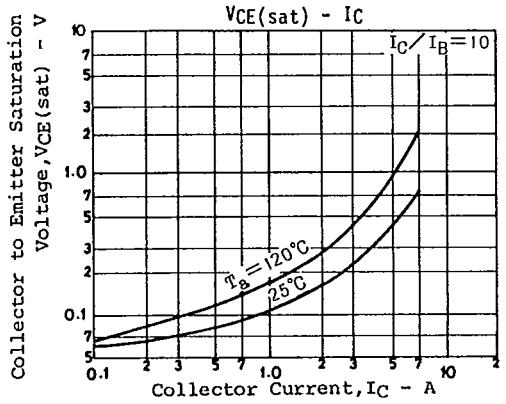
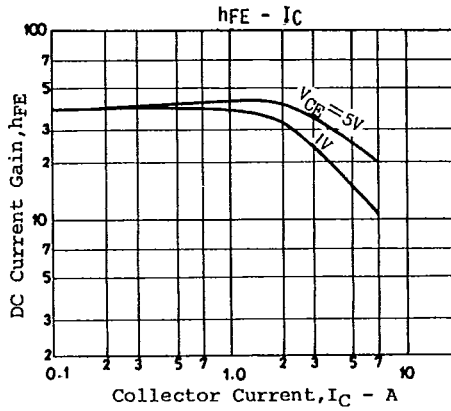
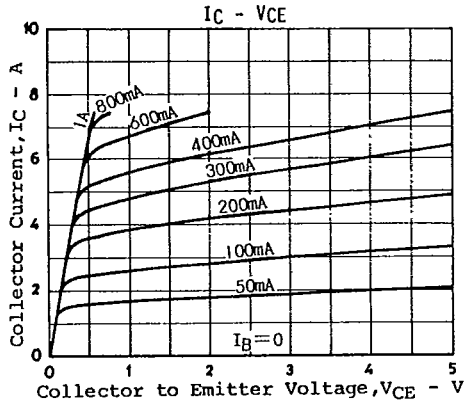

T-91-20

CASE OUTLINES AND ATTACHMENTS

- All of Sanyo Transistor case outlines are illustrated below.
- All dimensions are in mm, and dimensions which are not followed by min. or max. are represented by typical values.
- No marking is indicated.

Case Outline-[2003A]

unit:mm

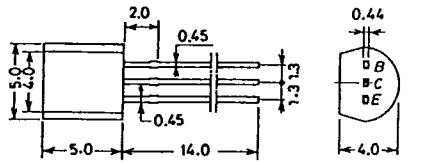

JEDEC: TO-92
EIAJ: SC-43
SANYO: NP

B. Base
C. Collector
E. Emitter

Case Outline-[2009A]

unit:mm

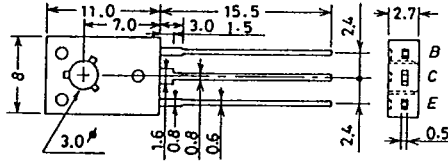

JEDEC: TO-126

B: Base
C: Collector
E: Emitter

Case Outline-[2004A]

unit:mm

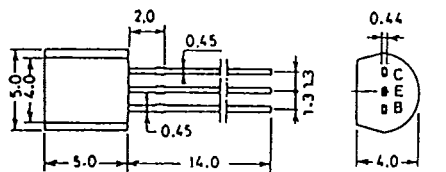

JEDEC: TO-92
EIAJ: SC-43
SANYO: NP

C. Collector
E. Emitter
B. Base

Case Outline-[2010A]

unit:mm

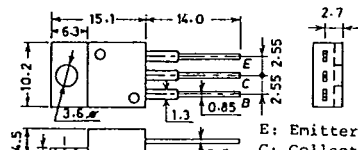

JEDEC: TO-220AB
EIAJ: SC-46

E: Emitter
C: Collector
B: Base

Case Outline-[2005A]

unit:mm

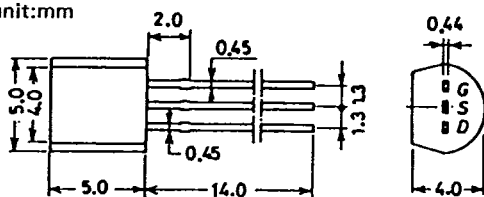

JEDEC: TO-92
EIAJ: SC-43
SANYO: NP

G: Gate
S: Source
D: Drain
B: Base
C: Collector

Case Outline-[2012]

unit:mm

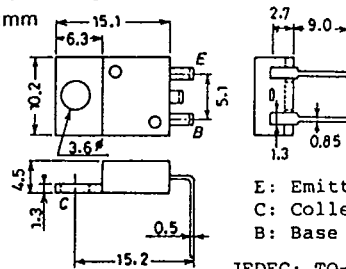

JEDEC: TO-220AA
EIAJ: SC-45

E: Emitter
C: Collector
B: Base

Case Outline-[2006A]

unit:mm

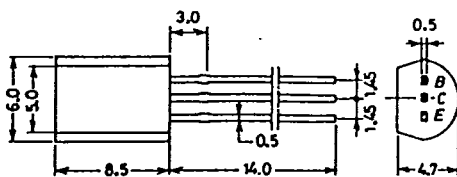

EIAJ: SC-51
SANYO: MP

B: Base
C: Collector
E: Emitter

Case Outline-[2013]

unit:mm

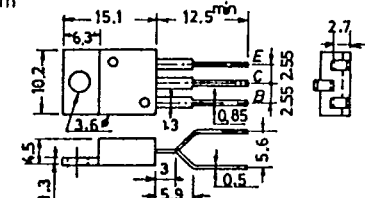

JEDEC TO-220

B: Base
C: Collector
E: Emitter

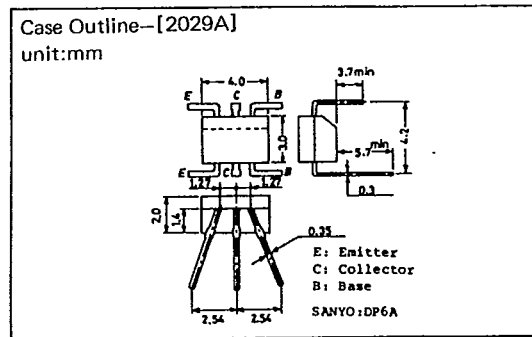
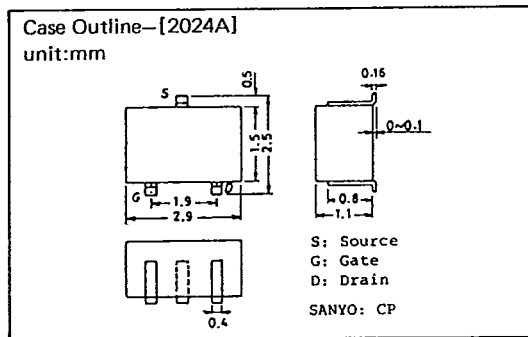
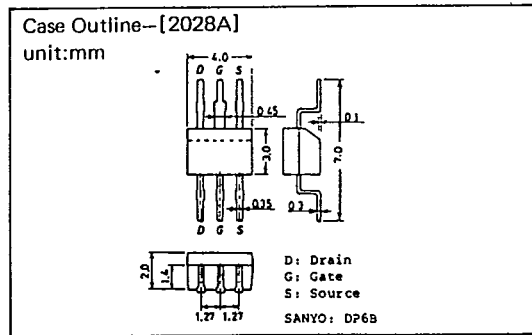
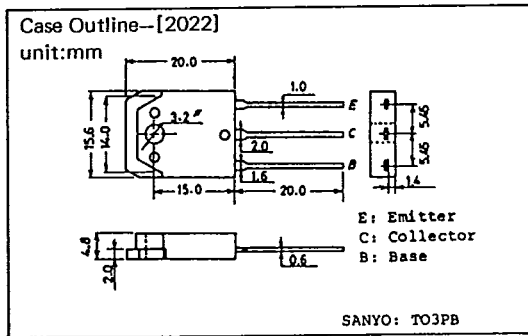
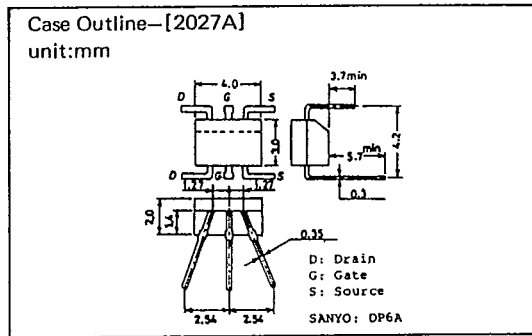
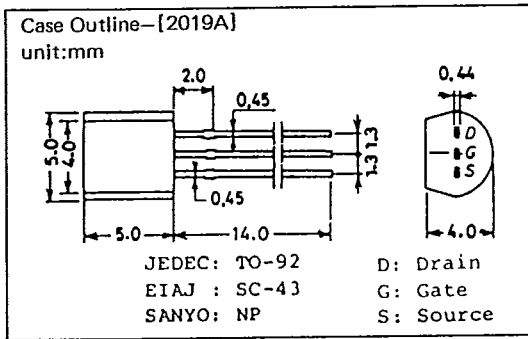
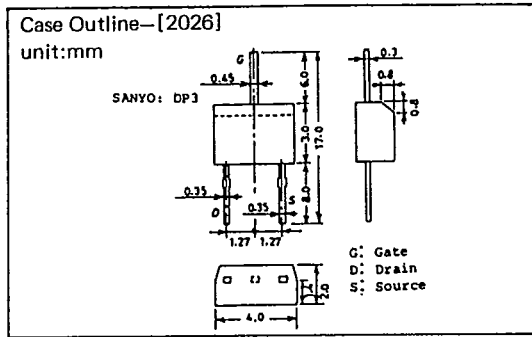
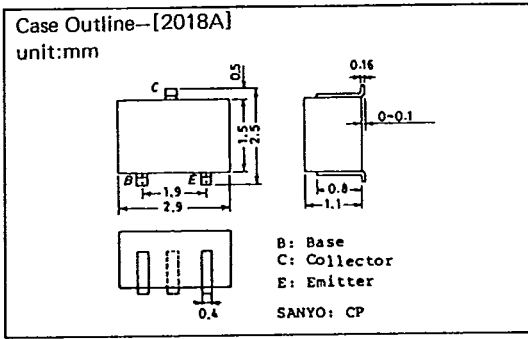
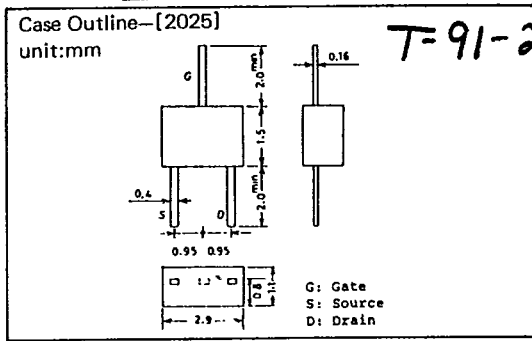
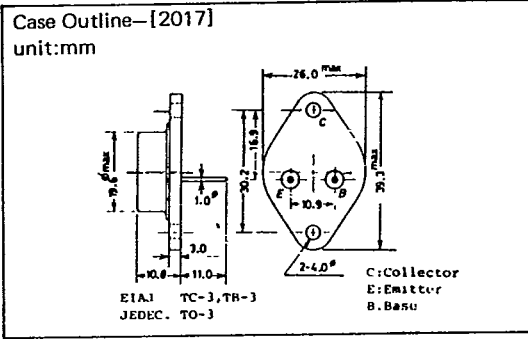

T-91-20

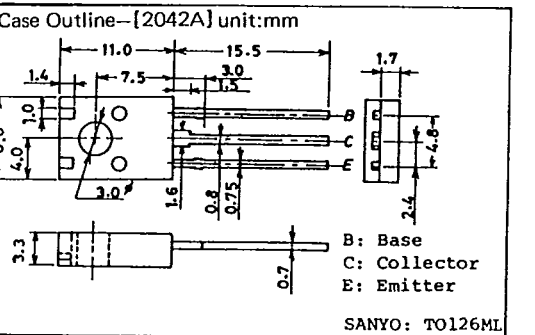
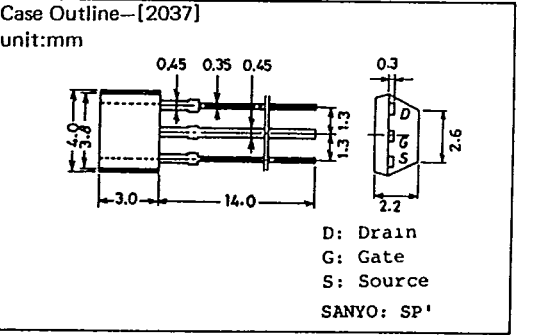
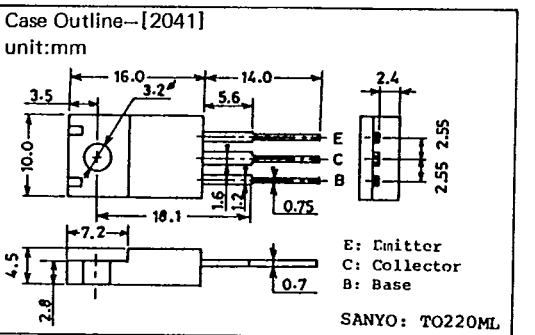
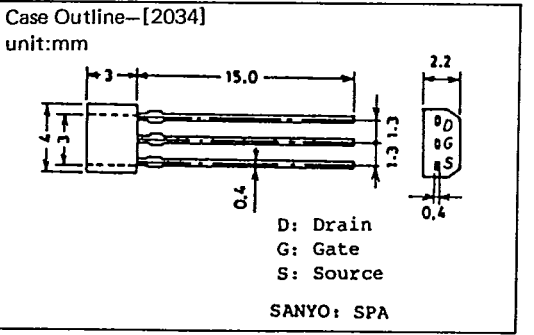
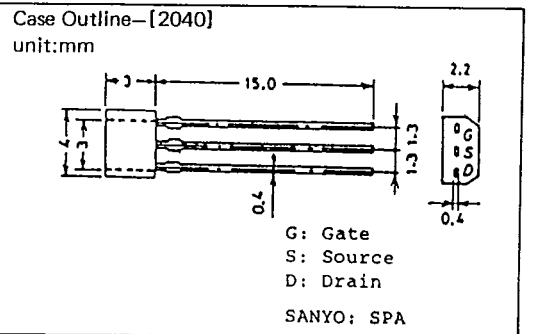
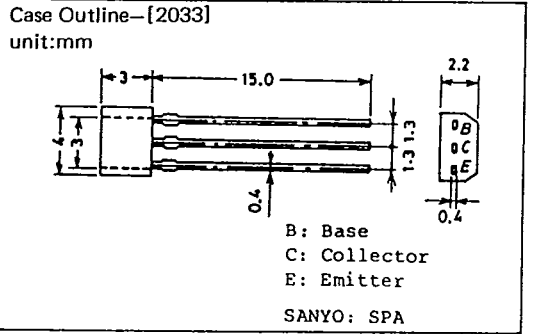
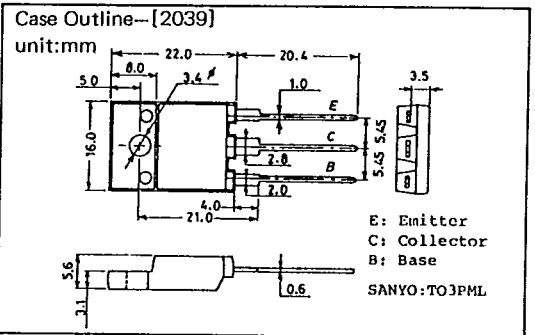
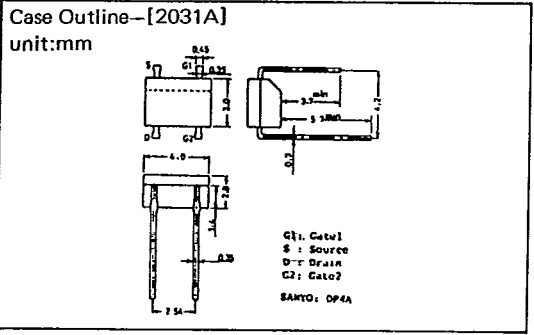
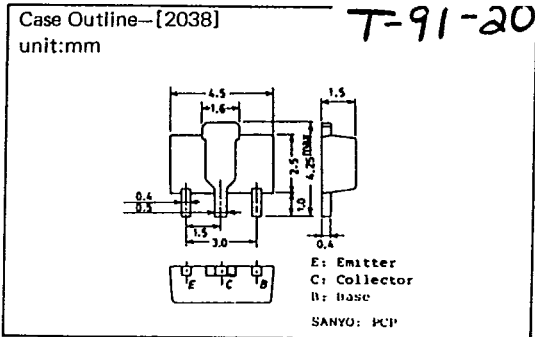
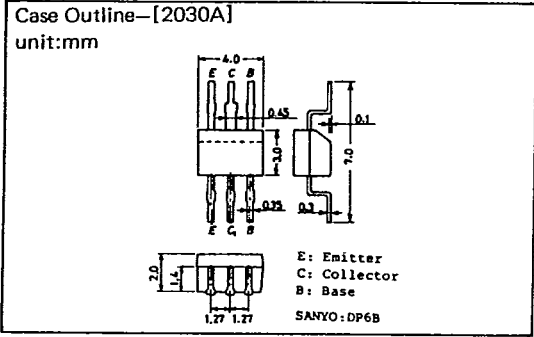

T-91-20

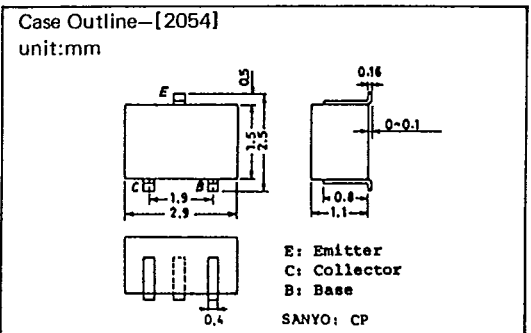
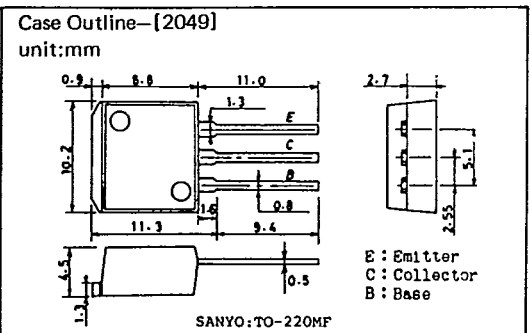
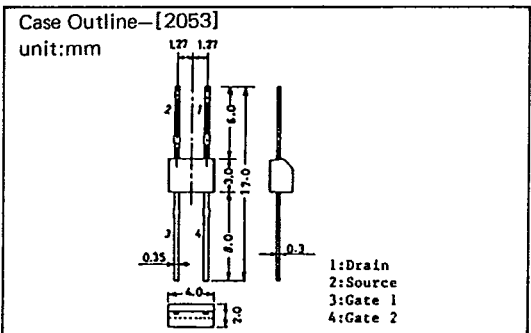
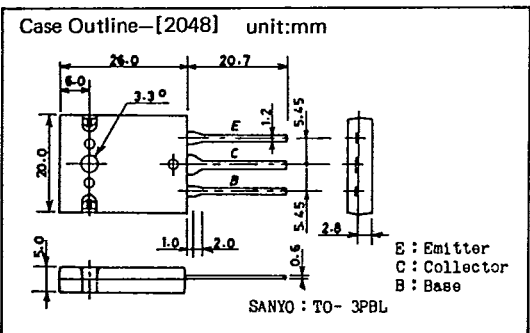
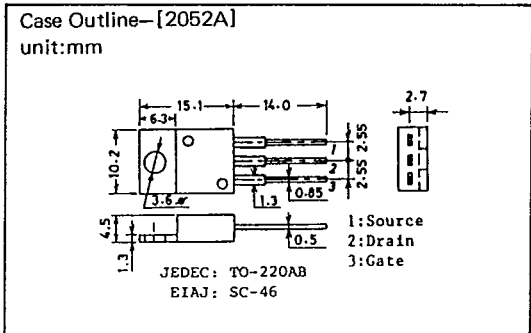
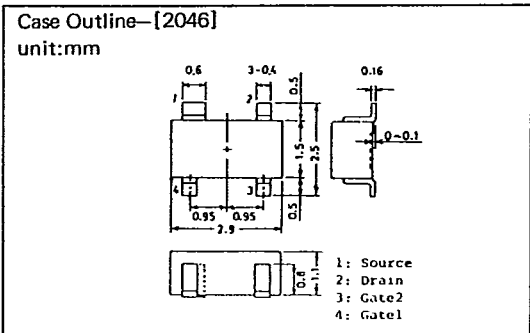
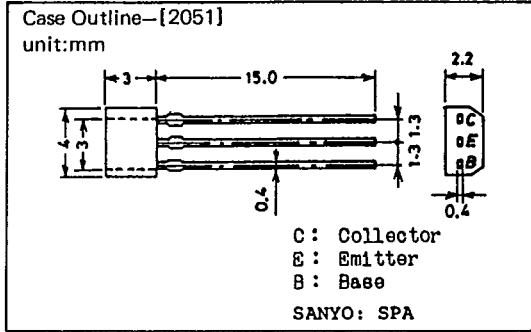
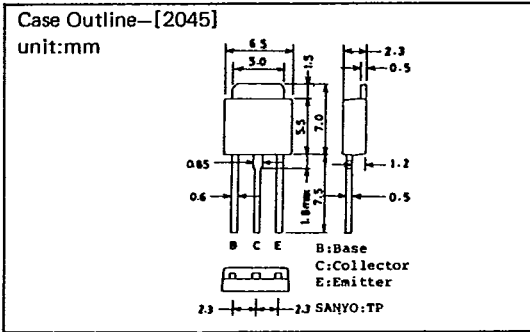
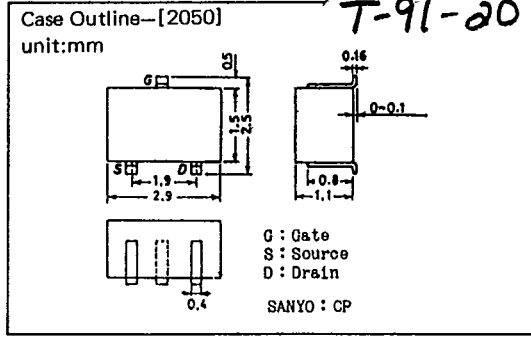
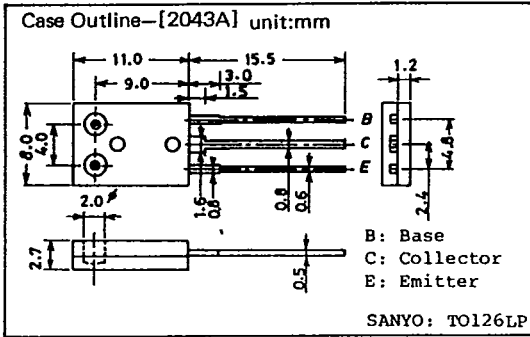

T-91-20

