

2SK688



2052A

N-Channel MOS
Silicon Field-Effect Transistor

T-39-11

High Speed Power Switching Applications

Features

Low-on resistance, very high-speed switching, converters

Absolute Maximum Ratings at Ta=25°C

			unit
Drain to Source Voltage	V_{DS}	60	V
Gate to Source Voltage	V_{GS}	± 20	V
Drain Current(DC)	I_D	15	A
Peak Drain Current(Pulse)	$I_{D peak}$	25	A
Allowable Power Dissipation	P_D	60	W
Junction Temperature	T_J	150	°C
Storage Temperature	T_{stg}	-55 to +150	°C

Electrical Characteristics at Ta=25°C

			min	typ	max	unit
D-S Breakdown Voltage	V_{DSS}	$I_D=1mA, V_{GS}=0$	60			V
Drain Current	I_{DSS}	$V_{DS}=60V, V_{GS}=0$			100	uA
G-S Leakage Current	I_{GSS}	$V_{GS}=\pm 20V, V_{DS}=0$			± 100	nA
Cutoff Voltage	$V_{GS(off)}$	$V_{DS}=10V, I_D=1mA$	1.5		4.0	V
Forward Transfer Admittance	$ y_{fs} $	$V_{DS}=10V, I_D=8A$	4.0	5.5		S
Saturation Resistance	$r_{DS(on)}$	$I_D=8A, V_{GS}=10V$	0.08	0.12		ohm
Input Capacitance	C_{iss}	$V_{DS}=20V, f=1MHz$		900		pF
Output Capacitance	C_{oss}	$V_{DS}=20V, f=1MHz$		450		pF
Reverse Transfer Capacitance	C_{rss}	$V_{DS}=20V, f=1MHz$		180		pF
Turn-on Time	t_{on}	$I_D=5A, V_{GS}=10V$		90		ns
Turn-off Time	t_{off}	$I_D=5A, V_{GS}=10V$		110		ns

Note: Be careful in handling the 2SK688 because it has no protect diode between gate and source.

Switching Time Test Circuit

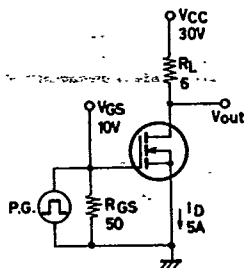

Case Outline 2052A (unit:mm)

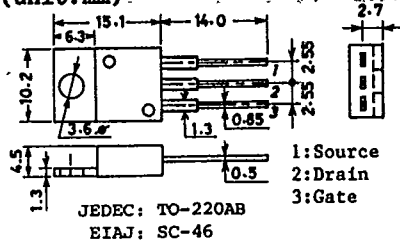

3267TA, TS No.2465-1/2

1787

2SK688

(T-39-11)

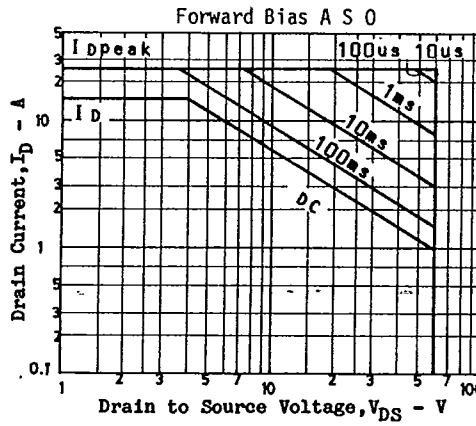
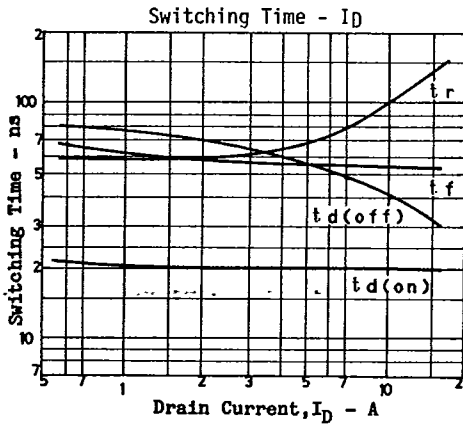
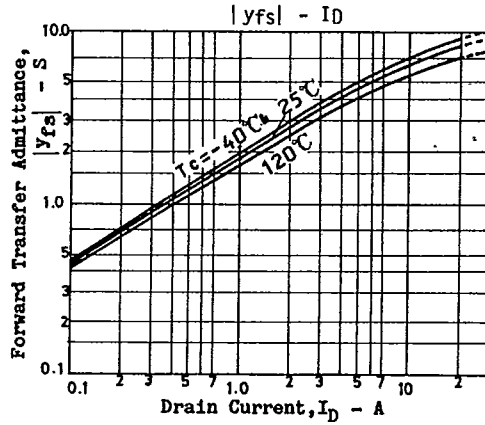
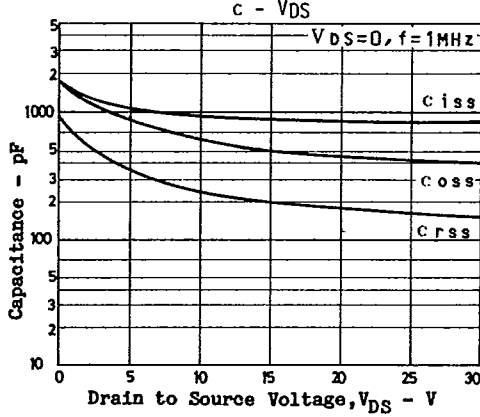
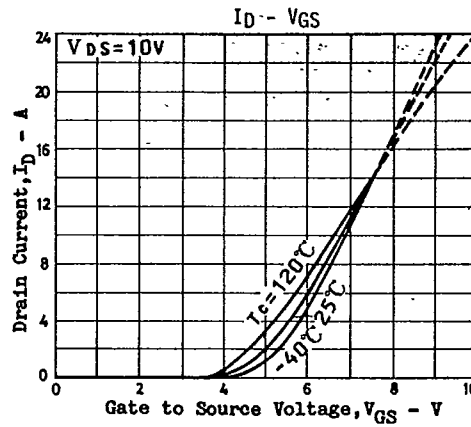
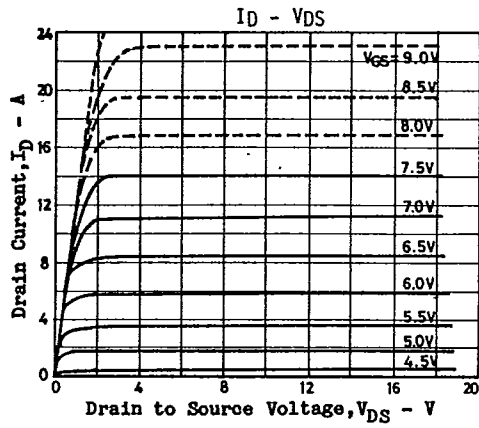

T-91-20

CASE OUTLINES AND ATTACHMENTS

- All of Sanyo Transistor case outlines are illustrated below.
- All dimensions are in mm, and dimensions which are not followed by min. or max. are represented by typical values.
- No marking is indicated.

Case Outline-[2003A]

unit:mm

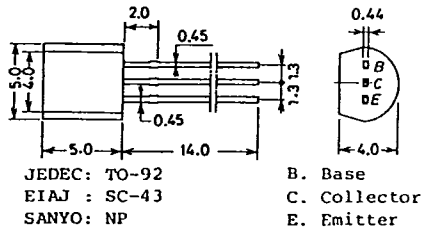

Case Outline-[2009A]

unit:mm

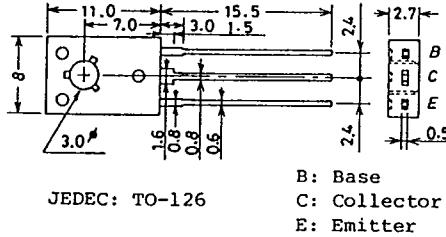

Case Outline-[2004A]

unit:mm

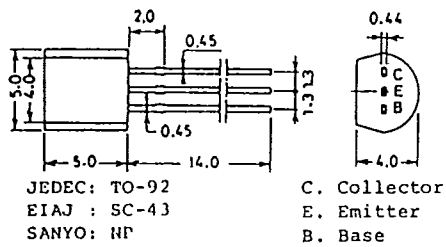

Case Outline-[2010A]

unit:mm

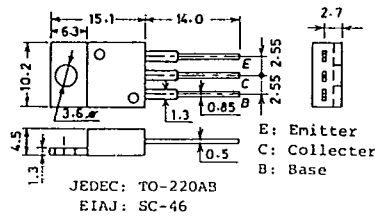

Case Outline-[2005A]

unit:mm

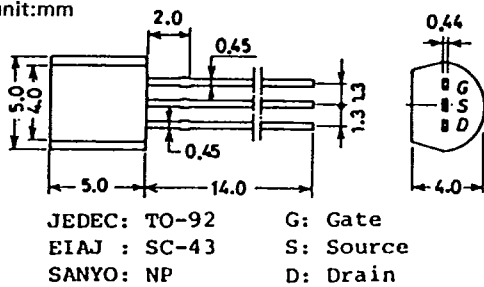

Case Outline-[2012]

unit:mm

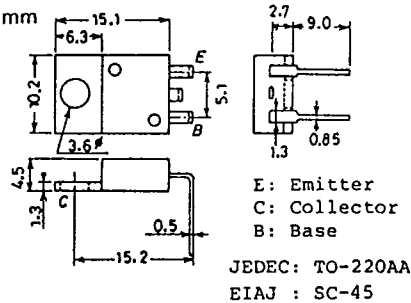

Case Outline-[2006A]

unit:mm

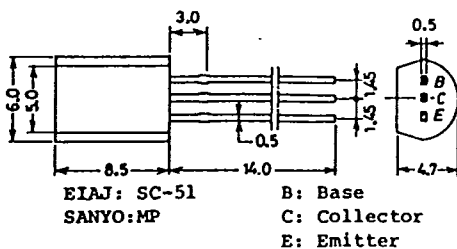

Case Outline-[2013]

unit:mm

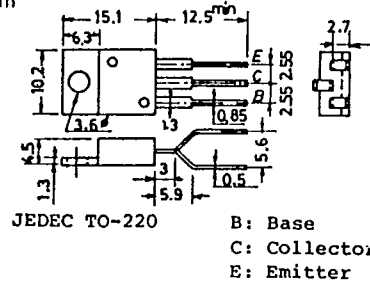

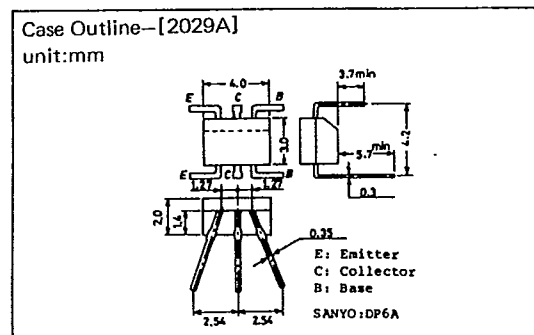
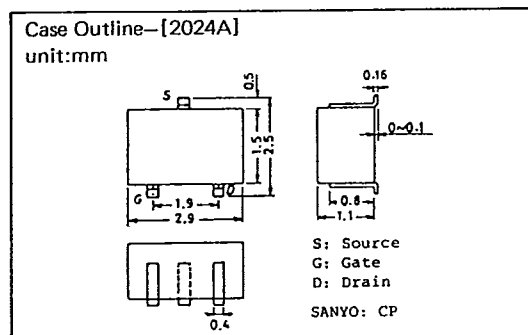
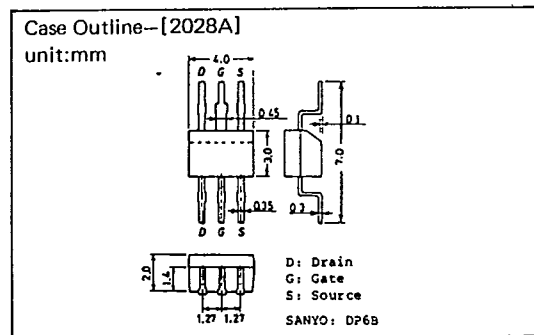
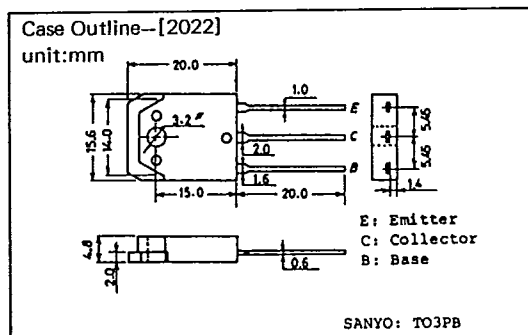
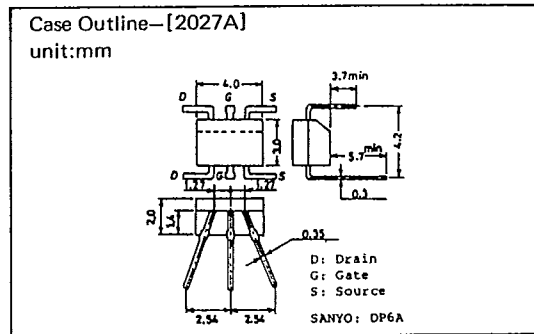
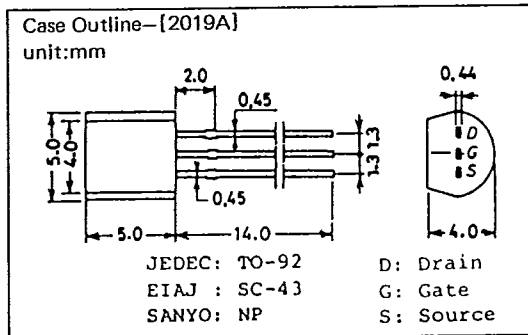
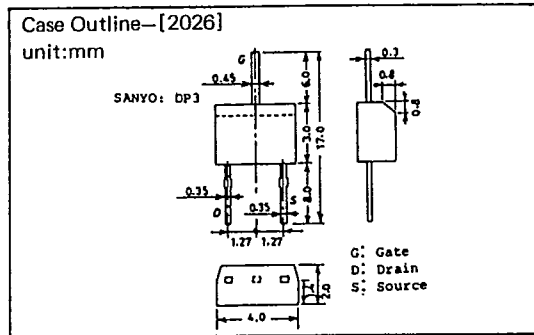
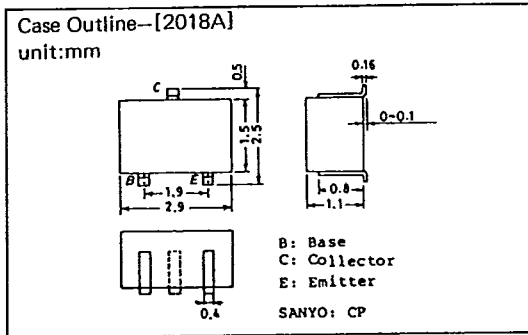
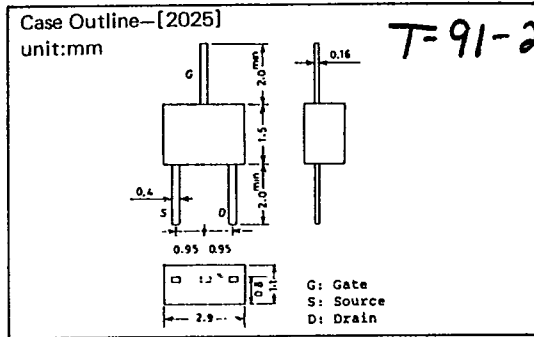
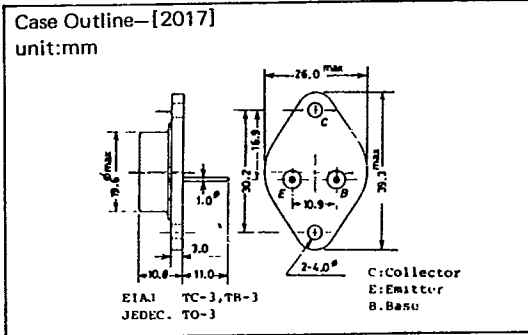

T-91-20

