

**TOSHIBA**

# Color Television

OWNER'S MANUAL

**CF19G22**

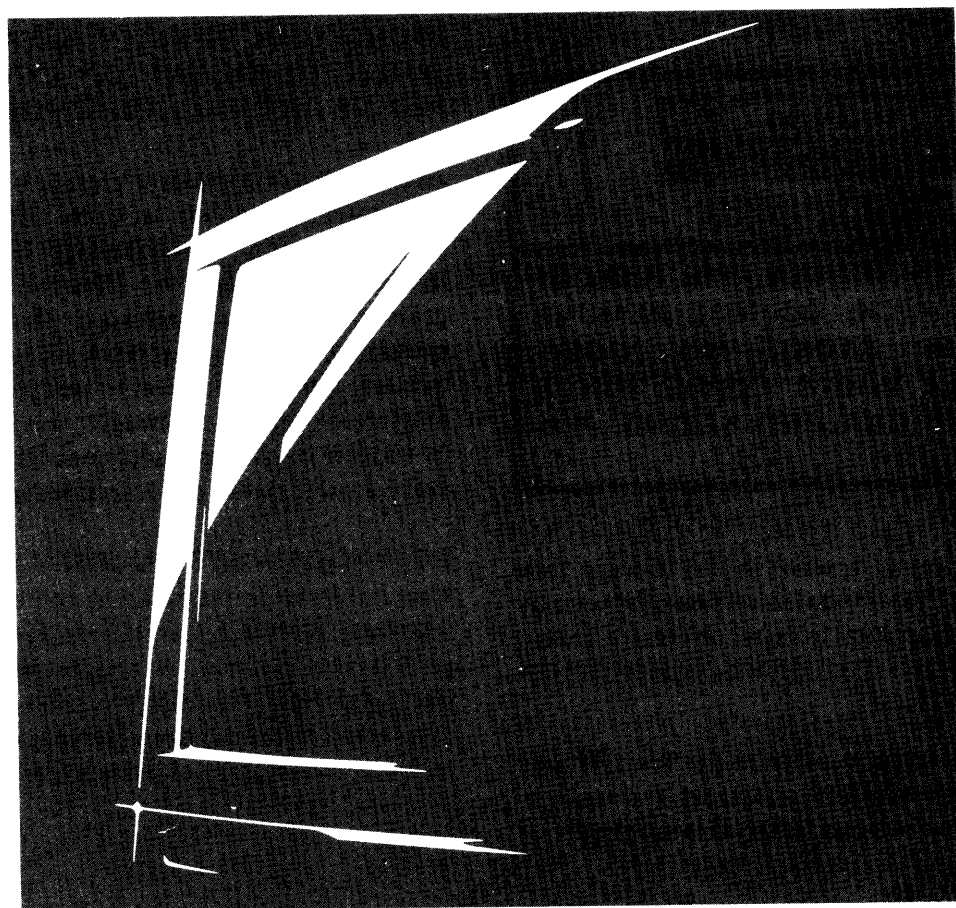

SET UP

BASIC OPERATION

ADVANCED  
OPERATION

REFERENCE  
SECTION

## Dear Customer

Congratulations! You have purchased one of the finest Color TV's on the market!

This manual will help you use the many exciting and useful features to make your TV viewing more enjoyable than ever before.

Before operating your TV set, please read all these safety and operating instructions completely and then retain for future reference.

## Customer's Record

You will find the model number and serial number on the back of your TV set.

Record these numbers in the spaces provided below. Refer to them whenever you call upon your TOSHIBA dealer regarding this product.

Model Number \_\_\_\_\_

Serial Number \_\_\_\_\_

# Safety Precautions

## WARNING:

TO REDUCE THE RISK OF FIRE OR ELECTRIC SHOCK, DO NOT EXPOSE THIS APPLIANCE TO RAIN OR MOISTURE.

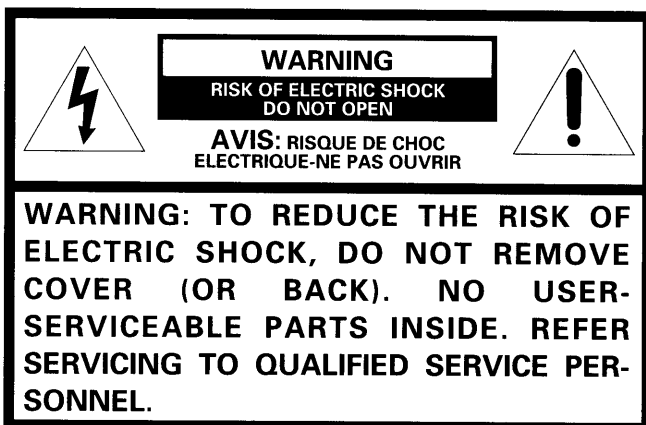

The lightning symbol in the triangle tells you that the voltage inside this product may be strong enough to cause an electric shock. DO NOT TRY TO SERVICE THIS PRODUCT YOURSELF.



The exclamation point in the triangle tells you that important operating and maintenance instructions follow this symbol.

## CAUTIONS:

TO PREVENT ELECTRIC SHOCK, DO NOT USE THIS POLARIZED PLUG WITH AN EXTENSION CORD RECEPTACLE OR OTHER OUTLET UNLESS THE PRONGS CAN BE FULLY INSERTED INTO THE OUTLET TO PREVENT ANY EXPOSURE OF THE PRONGS ON THE POLARIZED PLUG.

Avoid displaying stationary images on your TV screen for extended periods of time. Stationary patterns generated by computer displays, video games, stock market reports, etc. can become permanently engrained on the picture tube. This damage is not protected by your warranty as it is the result of misuse. Should you wish to use your TOSHIBA Television to display still images, it is always advisable to reduce brightness and contrast settings. Never leave a video game or computer display unattended.

## NOTE TO CATV SYSTEM INSTALLER IN THE USA:

This reminder is provided to call the CATV system installer's attention to Article 820-40 of the NEC that provides guidelines for proper grounding and, in particular, specifies that the cable ground shall be connected to the grounding system of the building, as close to the point of cable entry as practical.

# Table of Contents

## Set Up

Installing Your TV Set .....	3
Antenna/Cable TV Connection .....	4

## Basic Operation

Operation and Controls (TV Set) .....	5
Operation and Controls (Remote Control) .....	6
Menu Function (General Instructions) .....	7
Programming Channel Memory .....	8
Convenient Remote Functions .....	10

## Advanced Operation

Adjusting the Picture .....	11
Locking Channels .....	12
Operating Closed Captioning Feature .....	13

## Reference Section

Cleaning and Care .....	14
Before Calling Service Personnel .....	14
Limited United States Warranty .....	15
Specifications .....	Back cover

## Installing Your TV Set

### Where to install

Place the TV on the floor or on a sturdy platform. The mounting surface should be flat and steady.

### Lighting

Do not place the TV in a room where direct lighting strikes the screen. Use soft and indirect lighting.

### Air circulation

Place the TV far enough from the walls to allow proper ventilation. This will prevent the TV from overheating and avoid possible damage to the TV. Avoid dusty places too.

### Power supply

Plug into an electrical outlet with standard household power (120 volt AC, 60Hz). Do not change the plug's safety prong. See the right column.

### WARNING : TO AVOID PERSONAL INJURY

- Do not stand or climb on the TV.
- Do not put a VCR or any heavy object on top of the TV.

### CAUTION :

As a safety feature, the plug has one prong wider than the other. It will fit only one way into a standard electrical outlet. If the plug will not fit into the outlet, try turning it around. If the plug will not fit either way, the outlet is probably old and non-standard.

You will need to have a new outlet installed by an electrician.

**DO NOT CHANGE THE SAFETY FEATURE OF THE PLUG.**

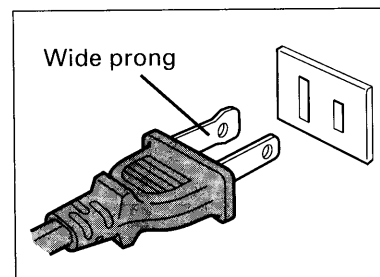

# Antenna/Cable TV Connection

You can use either an indoor or outdoor antenna to receive VHF and/or UHF channels. Channels 2 - 13 are VHF channels, and channels 14 - 69 are UHF channels. We recommend using an outdoor antenna for better picture quality. You can receive Cable TV by connecting a cable supplied by your local cable company.

SET UP

## Connecting an antenna or Cable without a decoder box

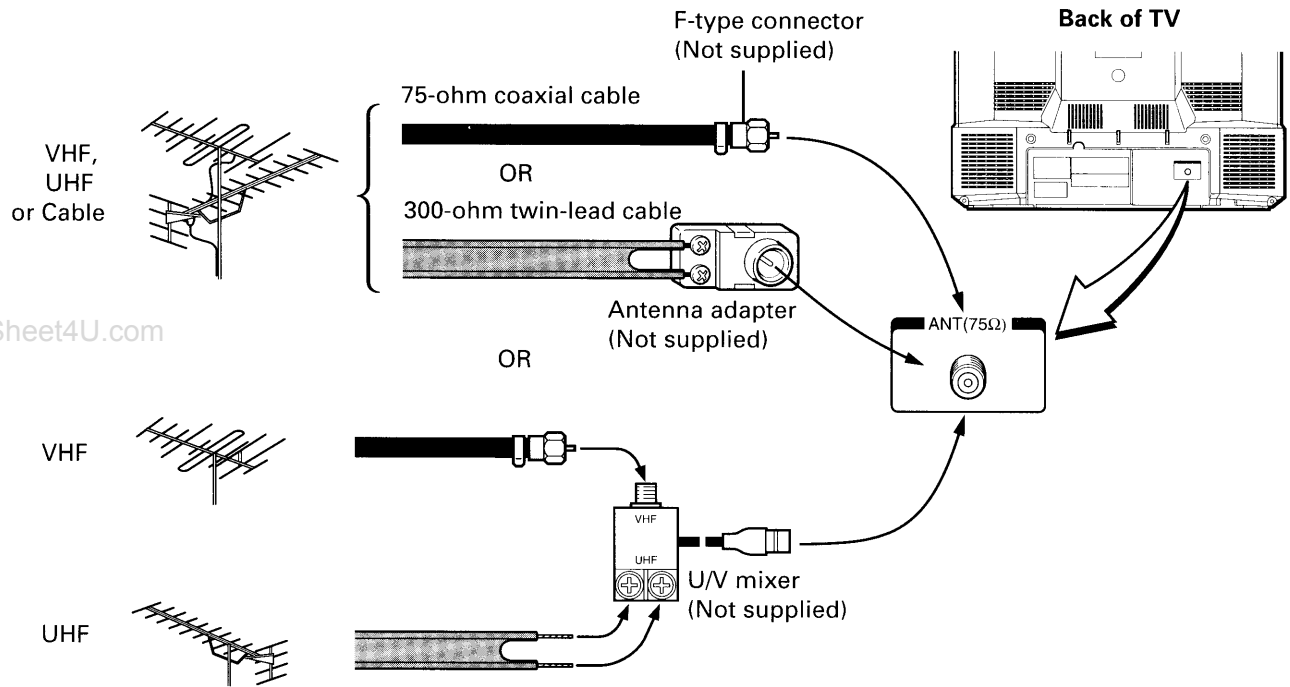

## Connecting a Cable box or VCR

- Follow this diagram if your cable company requires you to connect a cable box.
- Follow this diagram if you use a VCR.

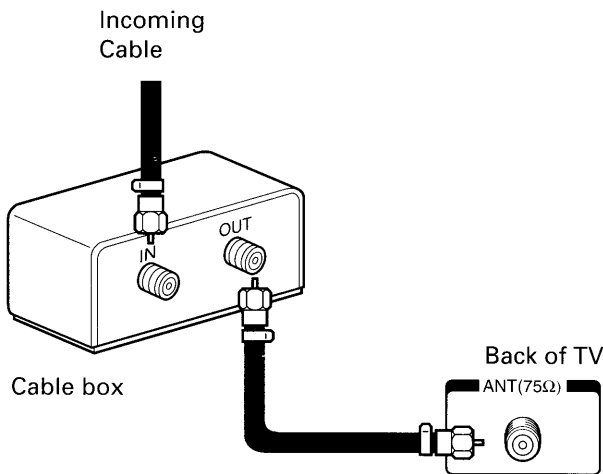

When selecting channels with the cable box, first tune your TV to the output channel of the cable box (usually 3 or 4).

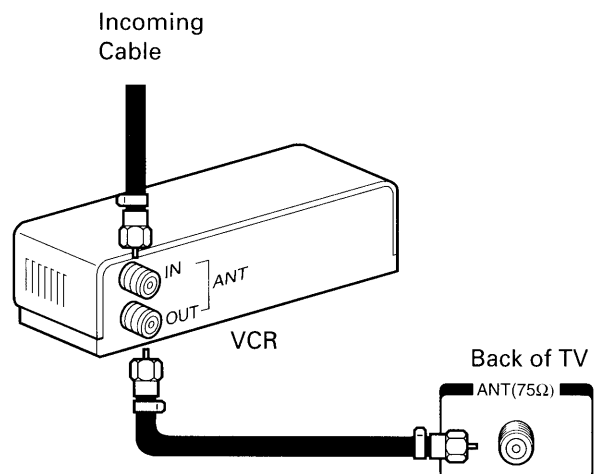

To watch video tapes, tune your TV to the output channel of the VCR (usually 3 or 4), then begin viewing the video tape.

# Operation and Controls (TV Set)

For the use of each control, refer to pages in brackets.

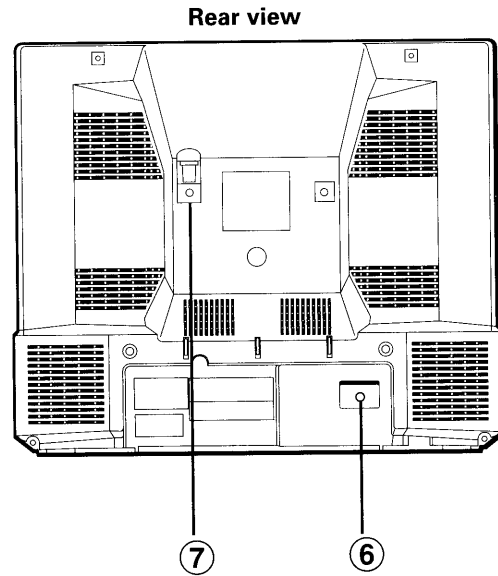
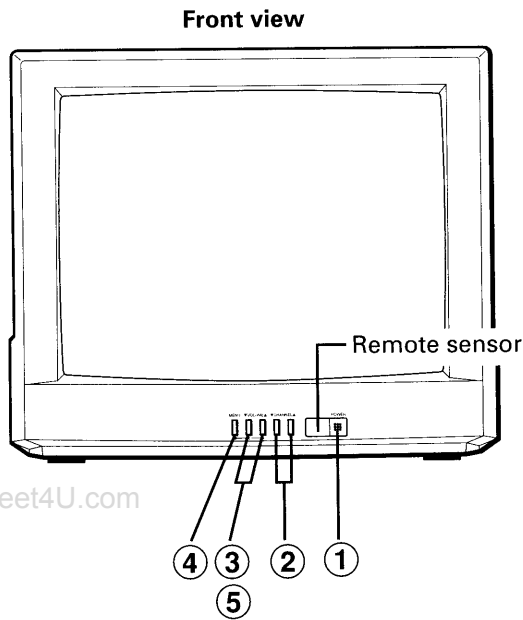

## First-Time Operation

Turn on TV and place channels in memory.  
See page 8.

- ① **POWER** button  
Press to turn on the TV.  
Press again to turn off the TV.
- ② **CHANNEL** ▼/▲ buttons  
Press ▲ to select next higher channel.  
Press ▼ to select next lower channel.
- ③ **VOLUME** ▼/▲ buttons (Dual function with ⑤)  
Press ▲ to increase the volume.  
Press ▼ to decrease the volume.

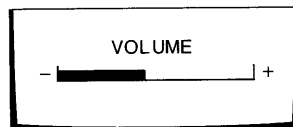

- ④ **MENU** button [7]
- ⑤ **</>** buttons [7]
- ⑥ **Antenna/Cable** terminal [4]
- ⑦ **Indoor antenna** socket

## Demonstration Mode

When this function is activated, your TV will automatically display a variety of its on-screen menus and special features.

This function is provided for demonstration purpose only.

To start the on-screen demonstration, select "DEMO:START" in the Option menu.  
See page 7 for details.

## Auto-Power-Off

If a vacant channel is tuned in or a TV broadcast has finished for the day, the TV automatically turns off after about 15 minutes. This feature does not operate in the VIDEO mode.

## Last Mode Memory

If the power is cut off while you are watching the TV and then later restored, the TV will turn back on automatically by the **Last Mode Memory** feature. To ensure that the power does not turn on, when you are away from home for a long time, unplug the power cord from the wall outlet.

# Operation and Controls (Remote Control)

This Remote Control allows you to control the functions of your TV set from 16 feet (5m) away. Before attempting to operate the Remote Control, install the batteries according to "Installing and replacing batteries" below. For specific use of each control, consult the corresponding page numbers in brackets.

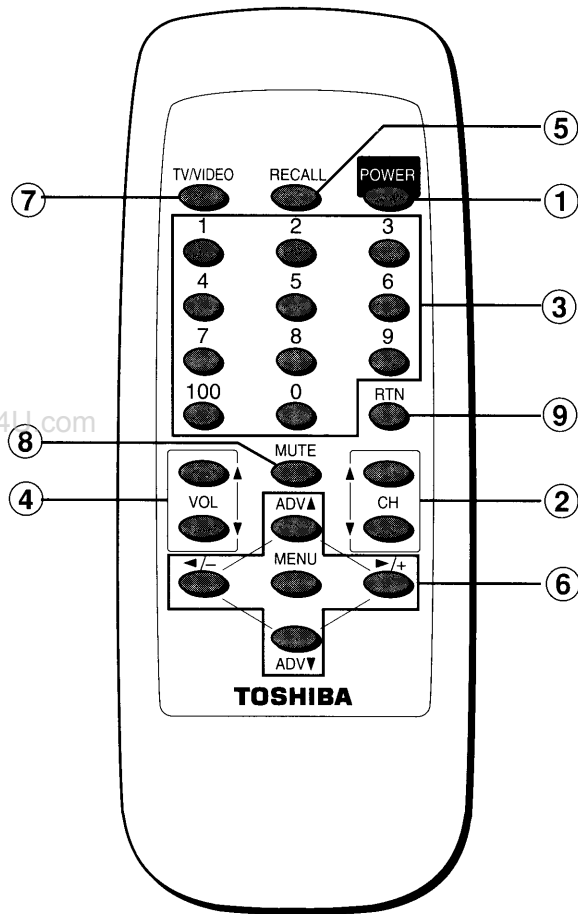

- ① **POWER** button  
Press to turn on the TV.  
Press again to turn off the TV.
- ② **CHANNEL ▲/▼** buttons  
Press ▲ to select next higher channel.  
Press ▼ to select next lower channel.
- ③ **Channel Number** buttons  
To select channel 4, press "4" (or press "0", "4").  
To select channel 38, press "3", "8".  
To select channel 125, press "100", "2", "5" in sequence.
- ④ **VOLUME ▲/▼** buttons  
Press ▲ to increase the volume.  
Press ▼ to decrease the volume.
- ⑤ **RECALL** button  
Press to display the channel number on the screen.
- ⑥ **Menu function** buttons [7]
- ⑦ **TV/VIDEO** button [10]
- ⑧ **MUTE** button [10]
- ⑨ **RTN** button [10]

BASIC OPERATION

## Installing and replacing batteries

- 1 Place the Remote Control with the face down, and remove the battery cover as shown.

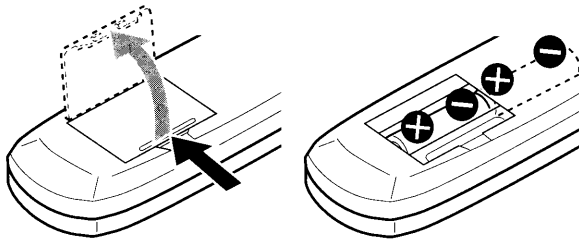

- 2 Place the two "AA" size batteries, matching the + and - signs on each battery to the + and - signs of the battery compartment.
- 3 Replace the battery cover until the lock snaps.

### CAUTIONS:

- Do not throw your batteries into a fire. Dispose of your batteries in a designated disposal area.
- Do not combine used old batteries with new ones.
- Do not mix battery types.

### Notes:

- If your Remote Control does not always adjust the set as you wish, you probably need to replace the batteries.  
The life expectancy of the battery is about one year.
- Remove dead batteries immediately to prevent battery acid from leaking into the battery compartment.
- If you do not intend to use the Remote Control for a long period, remove the batteries.

# Menu Function (General Instructions)

We suggest you familiarize yourself with the procedure before using the Menu function. To adjust any TV feature, the use of the Menu function is required. The adjustments that can be made to the TV appear on the screen.

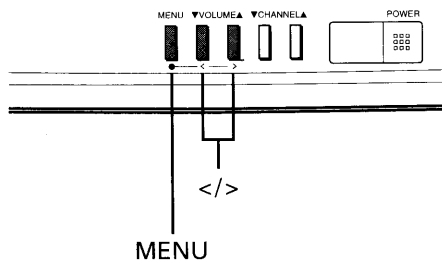

## MENU button (on Remote)

Each time you press **MENU**, the Picture, Setup or Option menu on-screen display is selected in order, then press **ADV**.

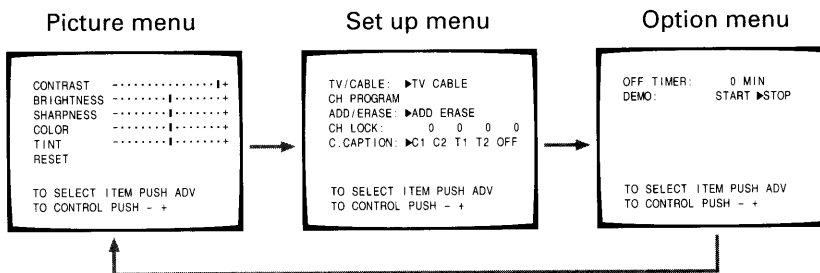

## MENU button (on TV)

Each time you press **MENU**, each item will be selected in order, then press **< or >**.

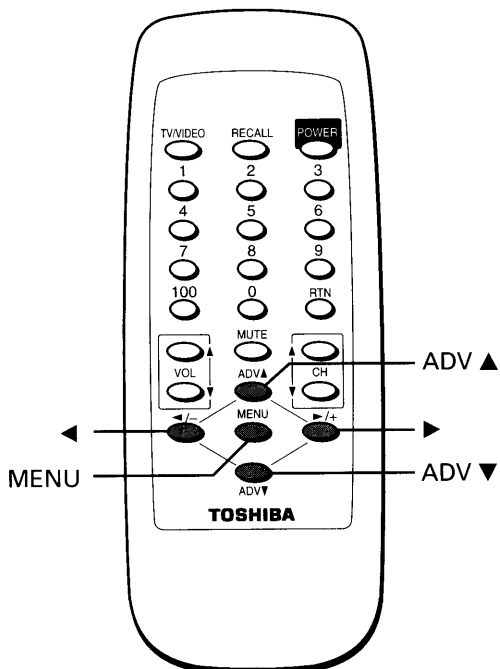

**Note:** The </> buttons on the TV will function as the VOLUME  $\nabla/\blacktriangle$  buttons when no menu display is on the screen.

## ADV button (on Remote)

Use **ADV** after you have selected the on-screen menu you want to adjust with the **MENU** button.

Each time you press **ADV**, the function to be adjusted will be selected in order.

**ADV  $\blacktriangle$**  button ..... from bottom to top

**ADV  $\blacktriangledown$**  button ..... from top to bottom

The selected function will be displayed in magenta.

## $\blacktriangleleft/\blacktriangleright$ (</>) buttons (on TV and on Remote)

Use  $\blacktriangleleft/\blacktriangleright$  (</>) to adjust the function you have selected with the **ADV** button on the Remote Control (or **MENU** button on the TV).

# Programming Channel Memory

The channel memory is the list of TV channel numbers your TV will stop on when you press the CHANNEL ▲ or ▼ button. **First, use the TV/CABLE and CH PROGRAM functions to preset all active channels in your area.** If necessary, arrange the preset channels with the ADD/ERASE functions so that you can tune into only desired channels.

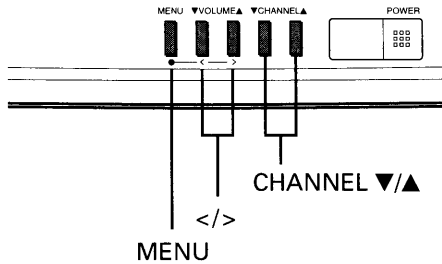

## TV/CABLE function

- 1 Press **POWER** to turn on the TV.
- 2 Press **MENU** (then **ADV ▲** or **▼**) repeatedly until "TV/CABLE" in the Set up menu is displayed in magenta.

```
TV/CABLE: ▶TV CABLE
CH PROGRAM
ADD/ERASE: ▶ADD ERASE
CH LOCK: 0 0 0 0
C. CAPTION: ▶C1 C2 T1 T2 OFF
```

TO SELECT ITEM PUSH ADV  
TO CONTROL PUSH - +

- 3 Press **◀ (<)** or **▶ (>)** until the mode that corresponds to your TV signal system is displayed in magenta.

**TV:** TV broadcasts signals.

(VHF channels 2 through 13 and  
UHF channels 14 through 69)

**CABLE:** Cable TV signals.

(Cable channels 1 through 125)

```
TV/CABLE: ▶TV CABLE
CH PROGRAM
ADD/ERASE: ▶ADD ERASE
CH LOCK: 0 0 0 0
C. CAPTION: ▶C1 C2 T1 T2 OFF
```

TO SELECT ITEM PUSH ADV  
TO CONTROL PUSH - +

## CH PROGRAM function

- 1 Press **MENU** (then **ADV ▲** or **▼**) repeatedly until "CH PROGRAM" in the Set up menu is displayed in magenta.

```
TV/CABLE: ▶TV CABLE
CH PROGRAM
ADD/ERASE: ▶ADD ERASE
CH LOCK: 0 0 0 0
C. CAPTION: ▶C1 C2 T1 T2 OFF
```

TO SELECT ITEM PUSH ADV  
TO CONTROL PUSH - +

- 2 Press **◀ (<)** or **▶ (>)** to start channel programming. The TV will automatically cycle through all the TV or CABLE channels depending on the mode selected, and store active channels in the channel memory.

PROGRAMMING NOW  
PLEASE WAIT

- 3 When channel programming is complete, you will see the message at the right.

COMPLETED

TV 4

- 4 Press **CHANNEL ▲** or **▼** to make sure the channel programming has been done properly.

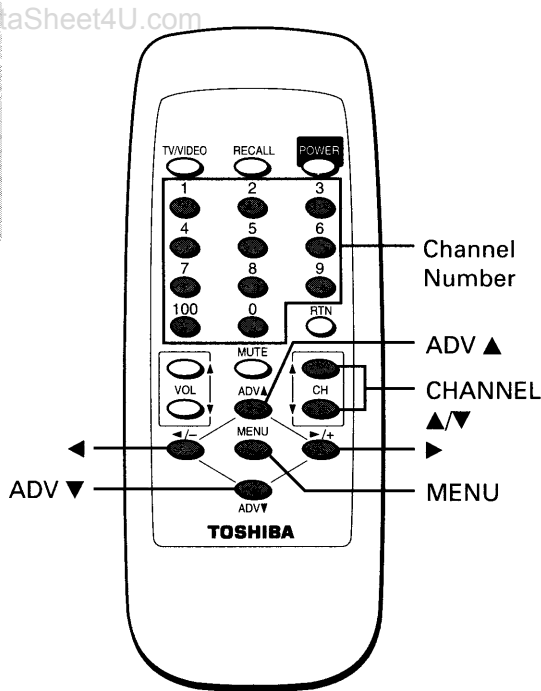



## ADD/ERASE function

After performing the CH PROGRAM function, you can add or erase specific channels.

- 1 Select the channel you want to erase using the **CHANNEL ▲** or **▼** button, or select the channel you want to add using the **Channel Number** buttons.

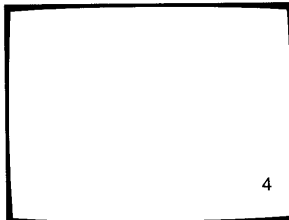

- 2 Press **MENU** (then **ADV ▲** or **▼**) repeatedly until "ADD/ERASE" in the Set up menu is displayed in magenta.

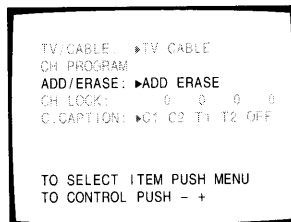

- 3 Press **◀ (<)** or **▶ (>)**:  
**To erase the channel**  
Press the button until "ERASE" is displayed in magenta indicating that the channel has been erased from the memory.

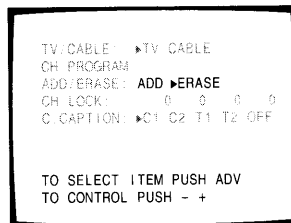

**To add the channel**  
Press the button until "ADD" is displayed in magenta indicating that the channel has been memorized.

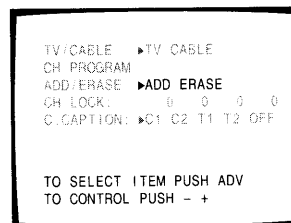

- 4 Repeat steps 1 to 3 for other channels.

You have now completed the channel programming.

# Convenient Remote Functions

## To select VCR channel

Press **TV/VIDEO** once to select channel 3 (VCR channel).  
Use this button to watch a video tape playing.  
To restore the TV channel, press **TV/VIDEO** again.

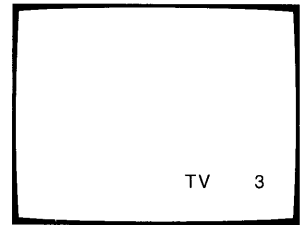

## To mute the sound

Press **MUTE** to mute the sound. The word "MUTE" will be displayed on the screen as shown. This is useful during telephone calls or other interruptions.  
To restore the sound, press **MUTE** again.

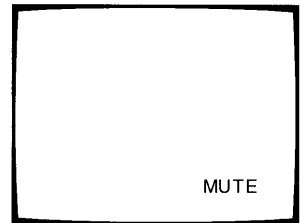

## To change quickly between two channels

Press **RTN** to return to the last channel viewed. This is useful should you want to view two channels. This allows you to view two programs without entering an actual channel number each time.

### To operate this function

- 1 Select the first channel you want to view.
- 2 Select the other channel with the Channel Number buttons.
- 3 Press **RTN**.  
The previous channel will return.

Each time you press **RTN**, the TV will switch back and forth between the two channels.

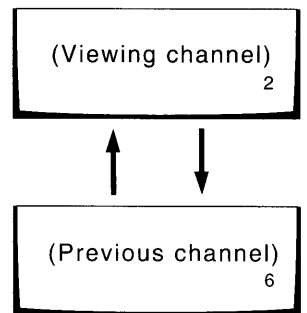

## To set the OFF-timer

With the OFF timer, you can set the TV to turn off automatically after a predetermined period of time (up to 3 hours, in 10 minute units).

- 1 Press **MENU** then **ADV ▲** or **▼** repeatedly until "OFF TIMER" in the Option menu is displayed in magenta.
- 2 Press **◀** or **▶** to enter the length of time you want the TV to stay on. If you press the "▶" button, the time display will increase 10 minutes or the "◀" button the time display will decrease 10 minutes.

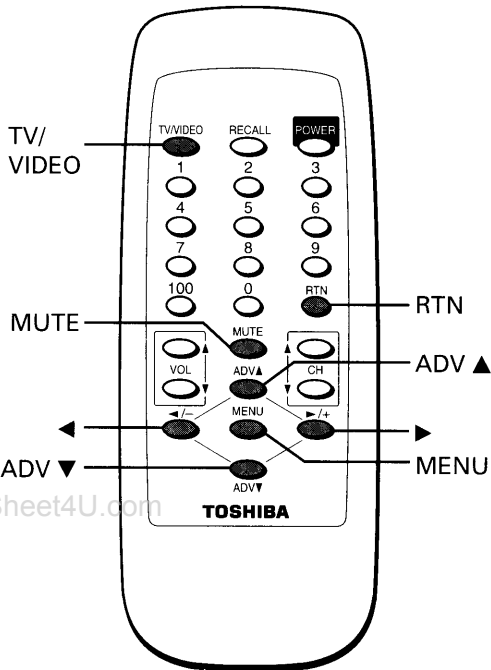
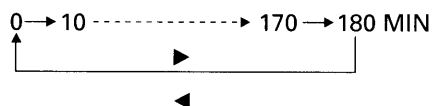
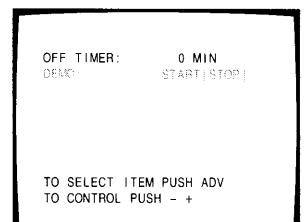

### Note on the MUTE function

When the MUTE button is pressed, the Closed-Captioned feature "C1" is activated. ("MUTE" on the screen display will disappear.) To deactivate, press the MUTE button again. (This feature only functions when the Closed Caption mode is set to "OFF".)

### Notes on the OFF-timer

- To cancel the setting, press **POWER**.  
To turn the TV on again, press **POWER**.
- The OFF-timer setting can also be performed using the **MENU** and **</>** buttons on the TV.

# Adjusting the Picture

You can adjust the picture quality (CONTRAST, BRIGHTNESS, SHARPNESS, COLOR and TINT) to suit your personal preference.

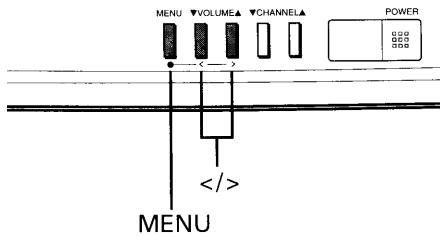

## To adjust the picture quality

- 1 Press **MENU** (then **ADV ▲** or **▼**) repeatedly until the selection in the Picture menu is displayed in magenta.

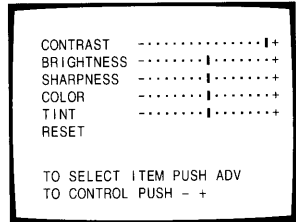

- 2 Press **◀** (<) or **▶** (>) to adjust the level.

**Example:** CONTRAST adjustment mode display

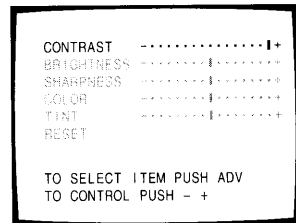

www.DataSheet4U.com

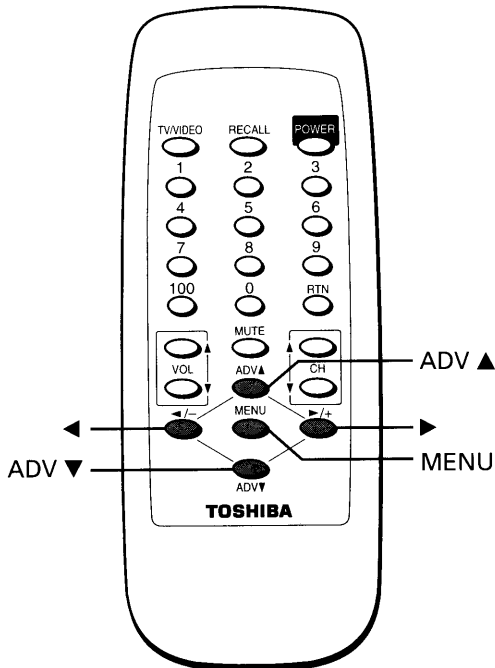

Selection	Pressing	
	-	+
CONTRAST	lower	higher
BRIGHTNESS	darker	lighter
SHARPNESS	softer	sharper
COLOR	paler	deeper
TINT	reddish	greenish

**To reset the PICTURE adjustment to the factory-preset level**  
 (maximum CONTRAST and all other adjustments centered)

- 1 Press **MENU** (then **ADV ▲** or **▼**) repeatedly until "RESET" in the Picture menu is displayed in magenta.

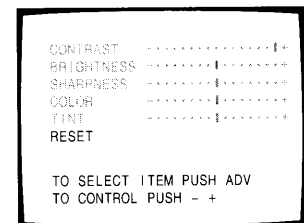

- 2 Press **◀** (<) or **▶** (>).

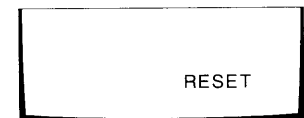

ADVANCED OPERATION

# Locking Channels

This feature allows you to program the TV so that any specific channel cannot be viewed without the use of the Channel Number buttons on the Remote Control.

There are 4 memory spaces for TV mode and 4 memory spaces for Cable mode

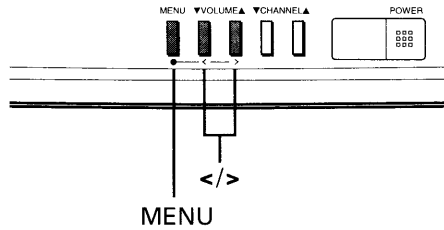

www.DataSheet4U.com

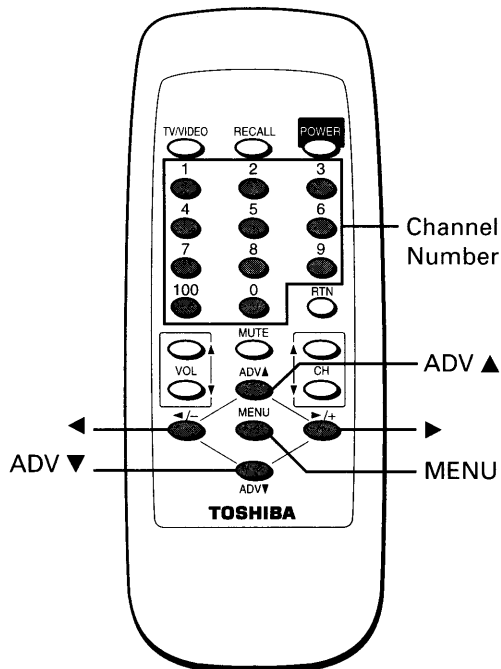

ADVANCED  
OPERATION

## To lock out channels

- 1 Select a channel you want to lock out. (**Example:** channel 4)
- 2 Press **MENU** (then **ADV ▲** or **▼**) repeatedly until "CH LOCK" in the Set up menu is displayed in magenta.

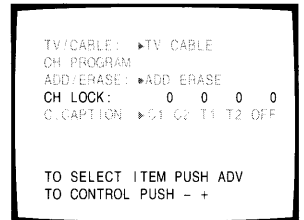

- 3 Press **◀** (<) or **▶** (>) until the channel number you selected "4" replaces the zero "0" in the channel lock program display.

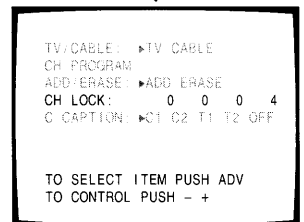

- 4 Repeat steps 1 to 3 for other channels.
- 5 Select another channel before turning off the TV..

**If you want to know the channels you have locked out**  
Press **MENU** to display the Set up menu.

## To restore channels

- 1 Select the channel you want to restore to normal viewing by pressing the **Channel Number** buttons. (**Example:** channel 7)
- 2 Press **MENU** (then **ADV ▲** or **▼**) repeatedly until "CH LOCK" in the Set up menu is displayed in magenta.

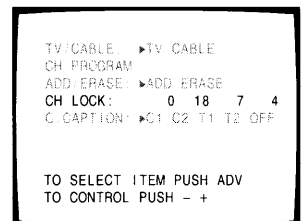

- 3 Press **◀** (<) or **▶** (>) until a zero "0" replaces the channel number ("7" in this example) in the channel lock program display.

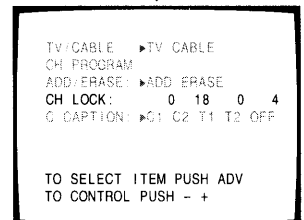

- 4 Repeat steps 1 to 3 for other channels.

# Operating Closed Captioning Feature

CAPTION mode  
example  
display (C1, C2)

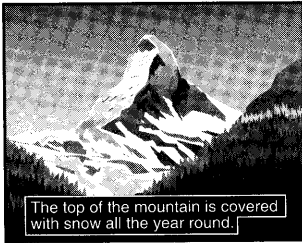

TEXT mode  
example  
display (T1, T2)

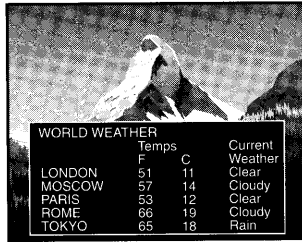

## CAPTIONS

Closed captioning provides an on-screen display of the dialogue, narration, and/or sound effects of a TV program.

Captions will appear at either the top or bottom of the screen while a captioned broadcast is shown.

Captioning is especially helpful for hearing impaired individuals.

## TEXT

Text is information that is presented on a portion of the TV screen. It is usually not related to the program.

For example, it could be a listing of the closed-captioned programs, news, weather information or stock market reports.

www.DataSheet4U.com

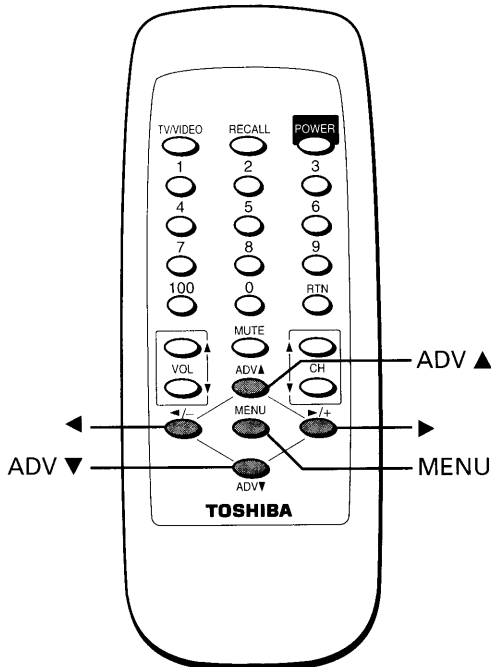
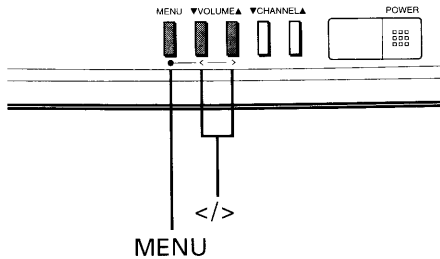

## To view captions or text

- 1 Select the desired program.  
The captioned programs are usually noted in your local TV listings by service marks such as "CC".
- 2 Press **MENU** (then **ADV ▲** or **▼**) repeatedly until "C. CAPTION" in the Set up menu is displayed in magenta.
- 3 Press **◀** (<) or **▶** (>) until "C1", "C2", "T1" or "T2" is displayed in magenta.  
The C2 mode may be utilized for alternate languages if they are being transmitted.

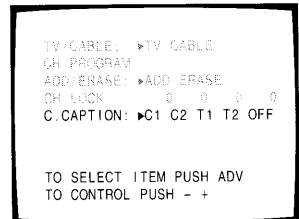

## To deactivate this feature

Select "OFF" in step 3 above.

## Notes:

- A closed captioned signal may not be decoded in the following situations.
  - When a video tape has been dubbed.
  - When the signal reception is weak.
  - When the signal has been changed or altered.
- If you select a Caption format channel and the "T1 or T2" mode, the TEXT screen will always be displayed. However, if the TEXT character signal is not transmitted, the characters are not displayed.

ADVANCED  
OPERATION

# Cleaning and Care

**WARNING: TV sets use High Voltage. Do not try to remove the cabinet back. Refer servicing to qualified service personnel.**

- To clean the TV screen:
    1. First remove the plug from the power outlet to avoid possible shock hazard.
    2. Use a clean cellulose sponge or chamois cloth dampened with a solution of mild detergent and warm water to clean TV screen and trim. Do not use too much water on the TV screen. Water spills into the cabinet and may cause damage to the TV. Avoid excess water.
    3. Remove any extra moisture with the same cloth or a dry one.
  - To maintain the finish and appearance of the cabinet, polish it from time to time with a quality furniture polish.
- Caution:** Never use strong solvents such as thinner, benzene or other chemicals on or near cabinet, as they might damage the finish of the cabinet.

## Before Calling Service Personnel

Before calling service personnel, please check the following chart for a possible cause of the problem you are experiencing. A minor adjustment on your part may eliminate the problem and restore your TV reception.

Problem	Checks and Adjustments
TV will not turn on	<ul style="list-style-type: none"> <li>● Make sure the power cord is plugged in, then press POWER button.</li> <li>● Check battery in remote. (Maybe batteries are "dead".)</li> </ul>
No picture, no sound	<ul style="list-style-type: none"> <li>● If watching VCR, make sure TV is tuned to channel 3 (or 4).</li> <li>● Check antenna/cable connections.</li> </ul>
No sound, picture OK	<ul style="list-style-type: none"> <li>● Maybe sound is muted. Try pressing VOLUME ▲ button.</li> <li>● Try another channel. (Maybe station trouble.)</li> </ul>
Poor sound, picture OK	<ul style="list-style-type: none"> <li>● Try another channel. (Maybe station trouble or local interference from appliance.)</li> </ul>
Poor picture, sound OK	<ul style="list-style-type: none"> <li>● Check antenna/cable connections.</li> <li>● Try another channel. (Maybe station trouble or local interference.)</li> <li>● Adjust Picture menu (page 11).</li> </ul>
Poor reception of broadcast channels	<ul style="list-style-type: none"> <li>● Try another channel.</li> <li>● Check antenna connections.</li> <li>● If using VCR, check TV/VCR switch on the VCR.</li> </ul>
No UHF, VHF OK	<ul style="list-style-type: none"> <li>● Make sure TV/CABLE function (page 8) is in "TV" mode.</li> </ul>
Unable to select a certain channel with CHANNEL ▲/▼ buttons	<ul style="list-style-type: none"> <li>● That channel may be locked out with CH LOCK function (page 12), or erased with the ADD/ERASE function (page 9).</li> </ul>
Multiple images (ghosts)	<ul style="list-style-type: none"> <li>● Try another channel. (Maybe station trouble.)</li> <li>● Use a highly directional outdoor antenna.</li> </ul>
Poor color or no color	<ul style="list-style-type: none"> <li>● Try another channel. (Maybe station trouble or local interference.)</li> <li>● Adjust TINT and/or COLOR in the Picture menu (page 11).</li> <li>● If you change the direction of the TV while the TV is activated, the picture may suffer from color shading. If so, turn off the TV, allow it to cool for about 30 minutes, then turn on the TV again. The picture should improve.</li> </ul>
The Remote Control does not operate	<ul style="list-style-type: none"> <li>● Maybe something was between the Remote and the remote sensor.</li> <li>● Maybe batteries are dead. Try replacing batteries with new ones. Insert them with the correct polarity.</li> </ul>

# Limited United States Warranty

Toshiba America Consumer Products, Inc. ("TACP") and Toshiba Hawaii Inc. ("THI") make the following limited warranties. These limited warranties extend to the original consumer purchaser or any person receiving this set as a gift from the original consumer purchaser and to no other purchaser or transferee.

## Limited Ninety (90) Day Warranty

TACP and THI warrant this product and its parts against defects in materials or workmanship for a period of ninety (90) days after the date of original retail purchase. During this period, TACP and THI will repair a defective product or part, without charge to you. You must deliver the entire set to an Authorized TACP/THI Service Station. You pay for all transportation and insurance charges for the set to and from the Service Station.

## Limited One (1) Year Warranty

TACP / THI further warrant the parts in this product against defects in materials or workmanship for a period of one year after the date of original retail purchase. During this period TACP/THI will replace a defective part without charge to you, except that if a defective part is replaced after ninety (90) days from the date of original retail purchase you pay labor charges involved in the replacement. You must also deliver the entire product to a TACP/THI Authorized Service Station. You are responsible for all transportation for the set to and from the Service Station.

## Limited Two (2) Year Warranty of Picture Tube

TACP and THI further warrant the picture tube in this product against defects in materials or workmanship for a period of two (2) years after the date of original retail purchase. During this period, TACP/THI will replace a defective picture tube without charge to you, except that if a defective picture tube is replaced after ninety (90) days from the date of the original retail purchase, you pay labor charges involved in the replacement. You are responsible for all transportation and insurance charges for the set to and from the Service Station

## Rental Units

The warranty for rental units begins with the first rental of thirty (30) days from the date of shipment to the rental firm, whichever comes first.

## How to Obtain Warranty Service

If after following all of the operating instructions in this manual and checking the section "BEFORE CALLING SERVICE PERSONNEL", you find that service is needed;

- (1) In the U.S.A. call the TACP toll free number **1-800-631-3811** after you find a defective product or part to find the nearest Toshiba Authorized Service Station.
- (2) Arrange for the delivery of the product to the Authorized TACP/THI Service Station. Products shipped to the Authorized Service Station must be insured and safely and securely packed, preferably in the original carton, and a letter explaining the problem must be enclosed. You are responsible for all transportation and insurance charges to and from the Authorized Service Station.

In the Continental United States call:



HAWAII, 327 Kamakee Street, Honolulu, HA 96814  
(808) 521-5377

All warranties implied by state law, including the implied warranties of merchantability and fitness for a particular purpose, are expressly limited to the duration of the limited warranties set forth above. With the exception of any warranties implied by state law as hereby limited, the foregoing warranty is exclusive and in lieu of all other warranties, guarantees, agreements and similar obligations of manufacturer or seller with respect to the repair or replacement of any parts. In no event shall TACP or THI be liable for consequential or incidental damages.

No person, agent, distributor, dealer or company is authorized to change, modify or extend the terms of these warranties in any manner whatsoever. The time within which action must be commenced to enforce any obligation of TACP or THI arising under this warranty or under any statute, or law of the United States or any state thereof, is hereby limited to 90 days from the date you discover or should have discovered, the defect. This limitation does not apply to implied warranties arising under state law.

This warranty gives you specific legal rights and you may also have other rights which may vary from state to state. Some states do not allow limitation on how long an implied warranty lasts, when an action may be brought, or the exclusion or limitation of incidental or consequential damages, so the above provisions may not apply to you.



## ATTENTION CANADIAN CONSUMERS:

Canadian consumers are requested to complete the special Canadian "Warranty Registration Form" enclosed, and forward this completed form with a copy of bill of sale to TOSHIBA OF CANADA to "Register and Validate" their warranty.

Products must be purchased from an Authorized Canadian Dealer.

Products purchased in the U.S.A. and used in Canada are not covered by these warranties.

Products purchased in Canada and used in the U.S.A. are not covered by these warranties.

## Commercial Units

Products sold and used for commercial use have a limited ninety (90) day warranty for all parts, labor and picture tube.

## Owner's Manual and Demographic Card

You should read this owner's manual thoroughly before operating this product. You should complete and mail the enclosed Demographic card within ten days after you, or the person who has given you this product as a gift, purchased this product. This is one way to enable TACP/THI to provide you with better customer service and improved products. Failure to return the Demographic card will not affect your rights under this warranty.

## Your Responsibility

The above warranties are subject to the following conditions:

- (1) You must retain your bill of sale or provide other proof of purchase.
- (2) All warranty servicing of this product must be made by an Authorized TACP/THI Service Station.
- (3) **These warranties are effective only if the product is purchased and operated in the U.S.A. or Puerto Rico.**
- (4) Labor service charges for set installation, set up, adjustment of customer controls and installation or repair of antenna systems are not covered by this warranty. Reception problems caused by inadequate antenna systems are your responsibility.
- (5) Warranties extend only to defects in materials or workmanship as limited above and do not extend to any product or parts which have been lost or discarded by you or to damage to products or parts caused by misuse, accident, damage caused by Acts of God, such as lightning or fluctuations in electric power, improper installation, improper maintenance or use in violation of instructions furnished by us; or to units which have been altered or modified without authorization of TACP/THI.

# Specifications

TELEVISION SYSTEM	NTSC standard
CHANNEL COVERAGE	VHF; 2 through 13 UHF; 14 through 69 Cable TV; mid band (A-8 through A-1, A through I) super band (J through W) hyper band (AA through ZZ, AAA, BBB) ultra band (65 through 94, 100 through 125)
POWER SOURCE	120V AC, 60Hz
POWER CONSUMPTION	61W (average)
AUDIO POWER	1W
SPEAKER TYPE	2-3/4 inches round
DIMENSIONS	Width ..... 20-15/32 inches (520mm) Height ..... 17-13/32 inches (441mm) Depth ..... 18-25/64 inches (467mm)
MASS	34.4 lbs (16.5kg)
SUPPLIED ACCESSORIES	Remote Control with 2 size "AA" batteries

Design and specifications are subject to change without notice

## TOSHIBA AMERICA CONSUMER PRODUCTS, INC.

HEAD OFFICE/82 TOTOWA ROAD, WAYNE, NEW JERSEY 07470

FACTORY SERVICE CENTERS/NORTHEAST: 82 TOTOWA ROAD, WAYNE, NEW JERSEY 07470

MIDWEST: 1010 JOHNSON DRIVE, BUFFALO GROVE, ILLINOIS 60089-6900

WEST: 5490 E. FRANCIS ST., ONTARIO, CA 91761

SOUTHWEST: 1421 CHAMPION DRIVE, SUITE 304 CARROLLTON, TEXAS 75006

SOUTHEAST: 6115 JIMMY CARTER BLVD., SUITE C2, NORCROSS, GA 30071-4607

## TOSHIBA HAWAII, INC.

HEAD OFFICE/327 KAMAKEE STREET, HONOLULU, HAWAII 96814, U.S.A.

## TOSHIBA OF CANADA LTD.

HEAD OFFICE/191 McNABB STREET, MARKHAM, ONTARIO, L3R 8H2, CANADA TEL: (905) 470-5400

SERVICE CENTERS/TORONTO: 191 McNABB STREET, MARKHAM, ONTARIO, L3R 8H2, CANADA TEL: (905) 470-5400

MONTREAL: 1643, NORTH SERVICE RD., TRANS-CANADA HIGHWAY, DORVAL QUEBEC, H9P 1J1, CANADA

TEL: (514) 856-4100

VANCOUVER: 22171 FRASERWOOD WAY, RICHMOND, B.C. V6W 1J5

TEL: (604) 303-2500

MANUFACTURED BY

**TOSHIBA AMERICA CONSUMER PRODUCTS, INC.**

PRINTED IN USA

(97-02)B

# TOSHIBA

23562970