

Switch Mode NPN Transistors

(Pb) Lead(Pb)-Free

www.DataSheet4U.com

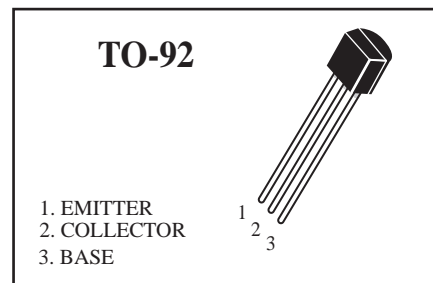

ABSOLUTE MAXIMUM RATINGS ($T_a=25^{\circ}\text{C}$)

Rating	Symbol	Value	Unit
Collector-Emitter Voltage	V_{CE0}	400	Vdc
Collector-Base Voltage	V_{CBO}	600	Vdc
Emitter-Base Voltage	V_{EBO}	6.0	Vdc
Collector Current	I_C	1.0	Adc
Total Device Dissipation $T_A=25^{\circ}\text{C}$	P_D	1.0	W
Junction Temperature	T_j	150	$^{\circ}\text{C}$
Storage, Temperature	T_{stg}	-55 to +150	$^{\circ}\text{C}$

ELECTRICAL CHARACTERISTICS

Characteristics	Symbol	Min	Max	Unit
Collector-Emitter Breakdown Voltage ($I_C= 1.0 \text{ mAdc}, I_E=0$)	$V_{(BR)CEO}$	400	-	Vdc
Collector-Base Breakdown Voltage ($I_C= 100 \text{ uAdc}, I_E=0$)	$V_{(BR)CBO}$	600	-	Vdc
Emitter-Base Breakdown Voltage ($I_E= 100 \text{ uAdc}, I_C=0$)	$V_{(BR)EBO}$	6.0	-	Vdc
Collector Cutoff Current ($V_{CB}= 600 \text{ Vdc}, I_E=0$)	I_{CBO}	-	100	uAdc
Emitter Cutoff Current ($V_{EB}= 6.0\text{Vdc}, I_C=0$)	I_{EBO}	-	100	uAdc

Electrical Characteristics (T_A=25 °C unless otherwise noted) (Continued)

Characteristics	Symbol	Min	Max	Unit
-----------------	--------	-----	-----	------

On Characteristics

DC Current Gain (I _C = 100 mA _{dc} , V _{CE} =10V _{dc}) (I _C = 200 mA _{dc} , V _{CE} = 10V _{dc}) (I _C = 10 mA _{dc} , V _{CE} = 10V _{dc})	h _{FE} (1)	20	25	-
	h _{FE} (2)	9	40	-
	h _{FE} (3)	6	.	-
Collector-Emitter Saturation Voltage (I _C = 200 mA _{dc} , I _B = 40 mA _{dc})	V _{CE(sat)}	-	0.8	V _{dc}
Base-Emitter Saturation Voltage (I _C = 200 mA _{dc} , I _B = 40 mA _{dc})	V _{BE(sat)}	-	1.1	V _{dc}
Current-Gain-Bandwidth Product (I _C = 100 mA _{dc} , V _{CE} = 10 V _{dc} , f=1.0MHz)	f _T	5.0	-	MHz

Switching Characteristics

Storage Time	V _{CC} =100V, I _C =1A I _{B1} =-I _{B2} =200mA	t _s	-	2.5	us
Fall Time		t _f	-	0.5	us

Classification of h_{FE}(2)

Rank						
Range	9-15	15-20	20-25	25-30	30-35	35-40

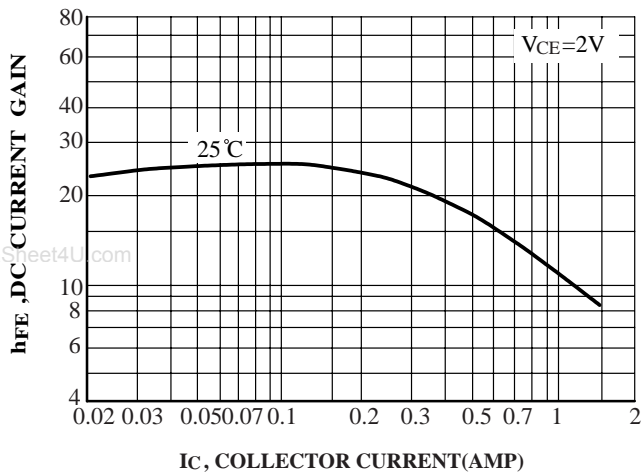

FIG.1 DC Current Gain

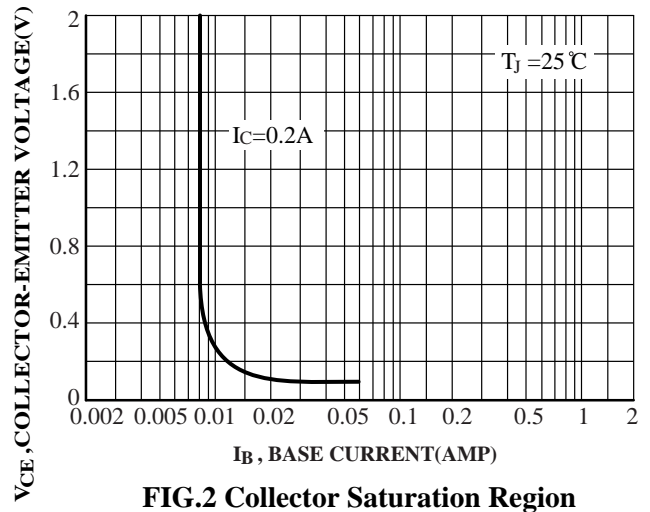

FIG.2 Collector Saturation Region

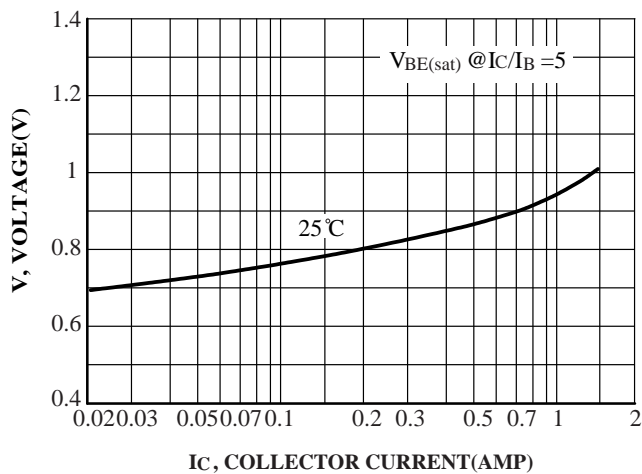

FIG.3 Base-Emitter Voltage

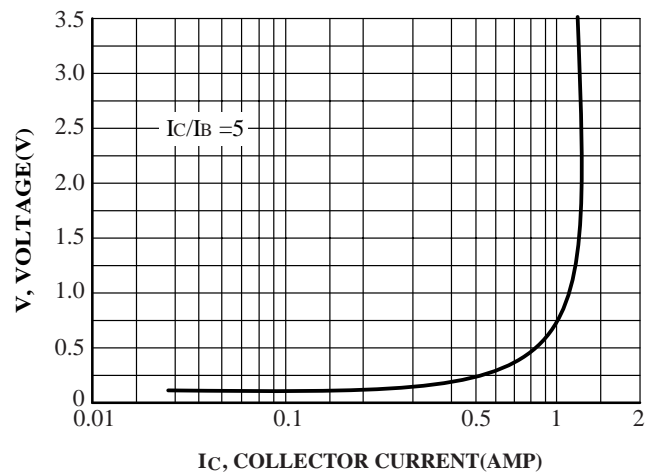

FIG.4 Collector-Emitter Saturation Region

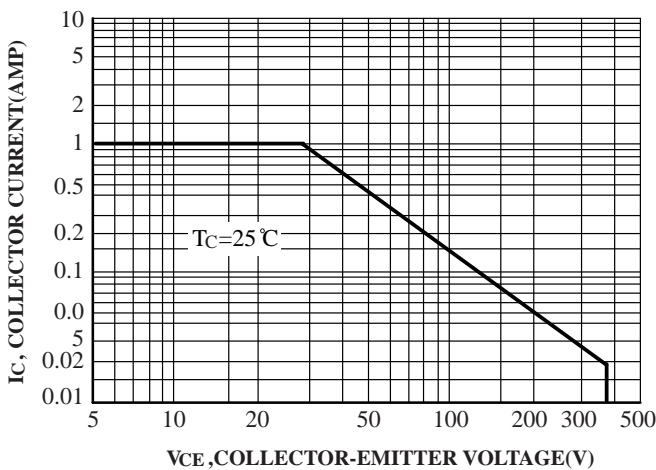

FIG.5 Active Region Safe Operation Area

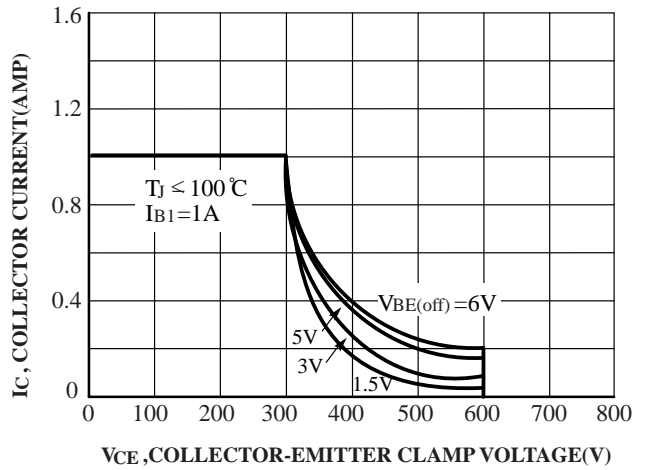

FIG.6 Reverse Bias Safe Operating Area

www.DataSheet4U.com

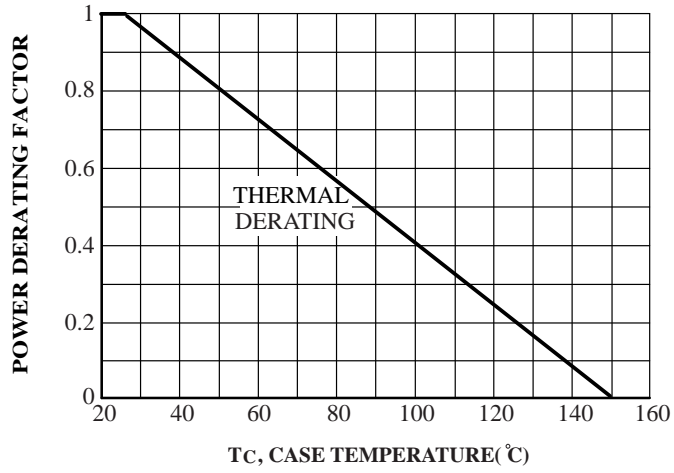
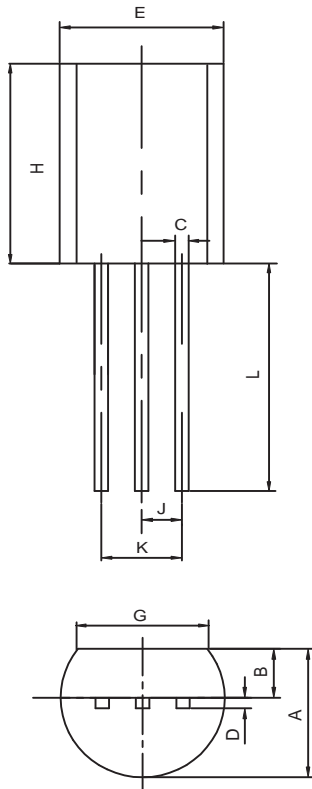

FIG.7 Forward Bias Power Derating

TO-92 Outline Dimensions

unit:mm



TO-92		
Dim	Min	Max
A	3.30	3.70
B	1.10	1.40
C	0.38	0.55
D	0.36	0.51
E	4.40	4.70
G	3.43	-
H	4.30	4.70
J	1.270TYP	
K	2.44	2.64
L	14.10	14.50